

# TOTO

## WASHLET

Instruction Manual



### washlèt

TCF794CG



- Thank you for your recent purchase of this product.  
Please read the enclosed information to ensure the safe use of your product.
- Be sure to read this Instruction Manual before using your product and keep it in a safe place for future reference.

# What functions are available on your product?

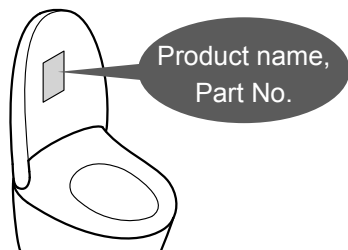

		Product name (Model)	WASHLET		
Functions		Part No.	TCF794CG	Ref. Page	
<b>Basic Functions</b>	Cleansing	Rear cleansing		14	
		Rear soft cleansing	●		
		Front cleansing			
	Changing the cleansing method	Wand position adjustment		●	14
		Water pressure adjustment			
		Oscillating cleansing			
		Pulsating cleansing			
	Changing the temperature	Temperature adjustment	●		18, 19
	<b>Sanitary Functions</b>	Removing odors	Deodorizer	●	16, 17
Bowl pre-cleaning		Pre-mist	●		
<b>Convenience Functions</b>	Heating the toilet seat	Heated seat	●	—	
	Save energy by lowering the toilet seat temperature	Auto energy saver		●	20, 21
		Auto energy saver+			
Timer energy saver					
<b>Maintenance</b>		Wand cleaning	●	27	

# Keep It Clean

## Sanitary Toilet



A mist is automatically sprayed inside the bowl unit to make it more difficult for dirt to adhere.

The self-cleaning functions operate automatically.  
(See pages 18,19 for details.)

	As you sit	As you stand up
Removing odors inside the bowl unit.	Deodorizer	Auto power deodorizer
A mist is automatically sprayed inside the bowl unit to make it more difficult for dirt to adhere.	Pre-mist	



## Table of Contents

Safety Precautions .....	4	Introduction
Operational Precautions .....	9	
Parts Names.....	10	
Preparation .....	12	
Basic Operations .....	14	Operation
Automatic Functions (Cleaning Features).....	16	
Deodorizer, Pre-mist		
Temperature Adjustment (Toilet Seat, Warm Water).....	18	
Energy Saver Features.....	20	
Maintenance .....	24	Maintenance
●Main Unit .....	25	
●Wand .....	26	
Wand cleaning		
●Deodorizing Filter .....	27	
●Spray Nozzle .....	28	
●Water Filter Drain Valve .....	29	
Changing Settings .....	30	Reference
What to Do?.....	34	
●If the water does not flow due to a water service interruption .....	34	
●If you cannot operate with the remote control.....	34	
●Freeze Damage Prevention.....	35	
●Long Periods of Disuse .....	36	
●Removal of Operation Guide .....	38	
Troubleshooting.....	39	
Specifications .....	43	
Safety Guidelines .....	44	
Warranty .....	45	
Important User Guidance Information.....	47	



# Safety Precautions

These precautions are important for safe usage. Be sure to follow them and use the product correctly.



## Symbols and Meanings

	<b>WARNING</b>	May result in death or serious injury.
	<b>CAUTION</b>	May result in injury or property damage.

The following symbols are used to indicate important safety instructions for the use of the product.

Symbol	Meaning
	This symbol indicates a prohibited use of the product.
	This symbol is used to indicate a required step in the use of this product.

- This product is classified as Class 1 Equipment and must be grounded.
- Install this equipment so that its power breaker is accessible.
- This appliance is not intended for use by persons (including children) with reduced physical, sensory or mental capabilities, or lack of experience and knowledge, unless they have been given supervision or instruction concerning use of the appliance by a person responsible for their safety.  
Children should be supervised to ensure that they do not play with the appliance.
- Use the new hose set included with this equipment. Do not reuse an old hose set.

 <b>WARNING</b>	
	<b>Do not touch the connection of power cord with wet hands.</b> • Doing so may cause electrical shock.
	<b>Do not get any water or cleaning solution on the main unit or connection of power cord.</b> • Doing so may cause fire, electrical shock, heat or short circuit. • Doing so may cause the product to crack resulting in injury or water damage.
	<b>Never disassemble, repair or alter.</b>
	<b>Do not use tools in places other than designated.</b> • Doing so may cause fire, electrical shock, overheating, short circuit or breakdown.
	<b>Do not install the product on moving vehicles such as wheeled vehicles or boats.</b> • Doing so may cause fire, electric shock, short circuit or malfunction. • The toilet seat, toilet lid, main unit, or other parts may come loose and fall off, resulting in injury.

## **WARNING**

### **Do not use the product if a malfunction occurs.**

- In case of breakdown or other problems, be sure to cut off power by flipping the power switch to OFF. Close the water shutoff valve to stop water supply.

Possible malfunctions:

- Water is leaking from a pipe or the main unit.
  - The product is cracked or broken.
  - The product makes a strange noise or emits a strange odor.
  - The product emits smoke.
  - The product is abnormally hot.
  - The toilet seat cushion is out of place.
- Continued use after malfunction could cause a fire, electric shock, heat, short circuit, injury or water damage.

### **Do not use other water than allowed by the laws and ordinances of the region of use. Only Use drinking water.**

#### **Do not use seawater or recycled water.**

- Doing so may cause irritation to the skin and malfunction.

### **Do not touch the connection of power cord during thunderstorms.**

- Doing so may cause electrical shock.

### **Do not allow the water supply hose to touch the connection of power cord.**

- Doing so may cause condensation resulting in a fire, electrical shock, heat or a short.

### **Do not do anything that may damage the power plug.**

Do not strike, yank, twist, excessively bend, damage, alter, or heat the power cords. Also, do not place anything heavy on, bind or pinch the power cords.

- Using a damaged power cord may result in a fire, electrical shock, heat or short.

### **Do not use any power supply other than the one specified.**

#### **AC 220-240 V, 50 Hz**

- Doing so may cause fire or excessive heat.

### **To reduce the danger of burns, death from electric shock, fire or other human injury:**

- Never operate this product if it has a damaged power cord or power connecting part, if it is not working properly, if it has been dropped or damaged, or if it has been dropped in water. Return the product to TOTO Europe GmbH for examination and repair.
- Never block the air openings of the product or place it on a soft surface, such as a bed or a couch, where the air openings could be blocked. Keep the air openings free of lint, hair or a similar material.
- Never use it while sleepy or drowsy.
- Never drop or insert anything into any opening or hose.
- Do not use it outdoors where aerosol (spray) products are being used or where oxygen is being administered.

### **Keep cigarettes and other open flames away from the product.**

- Failure to do so may cause fire.



# Safety Precautions (Continued)

## **WARNING**

### **Refrain from sitting on the seat for long periods.**

- It may cause low-temperature burns.

To prevent the following persons from getting a moderate temperature burn during use, other person should turn off the toilet seat heater.

- Young children, the aged and other users unable to set the temperature appropriately themselves.
- The ill, physically disabled and others who do not have freedom of movement.
- Those using any medicines that cause drowsiness (sleeping or cold medicine), those who have been drinking heavily, anyone severely fatigued and anyone else liable to fall asleep.

### **To reduce the danger of burns, death from electric shock, fire or other human injury:**

- Close supervision is necessary when this product is used by or near children or invalids.
- Use this product only for its intended use as described in this manual. Do not use accessories not recommended by the manufacturer.
- Keep the power cord away from heated surfaces.
- Connect this product to a properly grounded the power supply unit (device) only.
- The tank should only be filled with water.

**This is an electrical product. Do not install it anywhere water is likely to get on the product or anywhere with humidity high enough that water is likely to form on the surface of this product. When using the product in a bathroom, install a fan or ventilation port and ensure good air flow through the bathroom.**

- Failure to do so may cause fire or electrical shock.

### **Always connect the product to the cold water supply.**

- Connecting to hot water supply may result in burns and equipment damage.

### **Check that the power cord is connected correctly.**

- Failure to do so may cause fire, heat or short circuit.  
(When installing this product, observe the local laws and regulations regarding installation.)

**If the power cord is damaged, avoid danger by having the manufacturer's repair department or equivalent specialist replace it.**

### **Always flip the power switch to OFF before cleaning or maintenance.**

- Failure to do so may cause electrical shock or malfunction.

**When leaking battery fluid adheres to your body or clothes, wash it away with clean water.**

- The fluid may damage your eyes or skin.

## CAUTION

### **Do not use the product if the main unit is unstable.**

- Doing so may cause the main unit to come loose and fall, resulting in injury.  
(If there is backlash in the main unit, consult the installer, seller, or TOTO customer service.  
See contact information on the back cover.)

### **If the product is damaged, do not touch the damaged section.**

- Doing so may cause electrical shock or injury.  
Replace it immediately.

### **Do not apply strong force, mechanical shock, step on or stand on the toilet seat, toilet lid or main unit. Also do not place any heavy object on the toilet seat, toilet lid or main unit.**

- Doing so may cause cracking or cause the main unit to come loose and fall, resulting in injury.
- Doing so may damage the product and cause injury or water damage.

### **Do not lift up this product by the toilet seat or lid.**

### **Do not raise the toilet seat or lid while objects are resting on top of the unit.**

- Doing so may cause the main unit to come loose and fall, resulting in injury.

### **To reduce the danger of death from electric shock:**

- Do not use while bathing.
- Do not place or store the product where it could fall or be pulled into a tub or sink.
- Do not put in or drop into water or other liquid.
- Do not try to recover the product if it has fallen into water.  
Switch the breaker on the distribution board to OFF.

### **When cleaning or maintaining the plastic parts (main unit etc.) or the water supply hose, use a kitchen cleaner diluted with water. Do not use any of the following.**

Toilet cleaner, household cleaner, benzene, paint thinner, powdered cleanser or nylon scrubbing brush.

- These items may damage or crack the plastic and cause injury or malfunction.
- These items could damage the water supply hose and cause a water leak.

### **To prevent a sudden water leak, do not remove the water filter drain valve when the shutoff valve is open.**

- Doing so will cause water to spurt out.  
(Refer to Page 29 for instructions on cleaning the water filter drain valve.)

### **Do not fold or crush the water supply hose; do not damage by cutting with a sharp object.**

- Doing so may cause water leaks.



# Safety Precautions (Continued)

## CAUTION

**If a water leak should occur, always close the shutoff valve.**

**When the ambient temperature is likely to drop to 0°C or lower, prevent damage to the pipes and hoses due to freezing.**

- Frozen water pipes could cause the main unit and the pipes to break, resulting in a water leak.
- Regulate the room temperature to prevent the pipes and hoses from freezing during cold months.
- Drain the water.

**When not using the product for a long time, close the shutoff valve, drain the water from the main unit and water supply hose, and then flip the power switch to "OFF".**

- When using the product again, allow the product to refill with water first. Otherwise, the water in the tank might become contaminated and cause skin inflammation or other problems. (Refer to Page 37 for instructions on replenishing the water.)
- Leaving the power on may cause fire or heat.



**When installing the water filter drain valve, make sure that it is securely tightened in its proper position.**

- Failure to securely tighten it may cause a water leak.

**Make sure of the plus and minus signs on the batteries before inserting them. Remove depleted batteries immediately.**

**When replacing the batteries:**

**Replace both batteries with new ones.**

Use the same brand for both new batteries (any brand available).

- Failure to do so may cause the batteries to leak fluid, generate heat, rupture, or ignite.

**When the product is supposed not to be used for long time, remove the batteries from the remote control.**

- Failure to do so may cause the batteries to leak fluid.



# Operational Precautions

## ■ For prevention of malfunctions

- Do not block the remote control transmitter or receiver.

### < About the seat switch >

- When you sit on the toilet seat, the seat switch turns ON, enabling you to use various features. (A click sound is heard when the seat switch is ACTIVATED.)

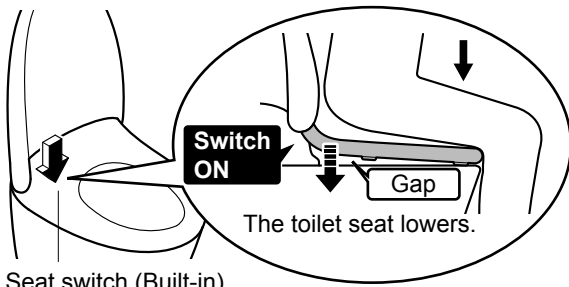

- Sit back on the toilet seat.
  - The seat switch will not turn on unless you sit on the seat properly.



### Note

- When a child uses the product, the seat switch may not be ACTIVATED by their light body weight.
- Since the toilet seat is designed to move up and down, a clearance is provided between the toilet seat cushion and the bowl unit.

## ■ For prevention of damage

- Wipe plastic areas such as the main unit and remote control with a soft cloth tightly wrung out with water.
- Do not lean against the toilet lid.



## ■ For prevention of malfunctions and failures

- Flip the power switch to OFF if there is a risk of lightning.
- A toilet seat cover or a toilet lid cover cannot be used. (The seat switch may not function properly.)



- Do not urinate on the main unit, toilet seat or wand. (Doing so may cause a failure or discoloration.)
- Do not apply strong forces to the control panel of the remote control.
- When using a toilet cleaner to clean the toilet, rinse it off within 3 minutes and leave the toilet seat and toilet lid open.
  - Wipe off any cleaner that remains on the bowl unit. (If vapor from a toilet cleaner enters the main unit, it may cause a malfunction.)
- Do not expose to direct sunlight. (Doing so may cause changes in color, irregular heated seat temperature, remote control malfunction or the product malfunction due to the change in temperature.)
- Use radios, etc. away from the product. (The product could cause interference with the radio signal.)
- If you use a booster seat for infants or a soft highchair, remove it after use. (Keeping it installed may prevent some of the functions from being used.)
- Do not apply force to the remote control. (May cause malfunction.)  
To prevent the remote control from being dropped, set it in the hanger when you are not using it. Be careful not to expose it to water.
- Do not place anything on the toilet seat and lid, and do not press them with hands. (Failure to do so may turn on the seat switch, causing the floor to get wet if buttons on the remote control are touched and warm water comes out from the wand.)

### About rear cleansing, rear soft cleansing and front cleansing

- **These functions wash away waste and dirt from a localized area of your body.**
- **Do not cleanse too much or for too long.** Doing so may wash away normal bacteria, upsetting the balance of bacteria inside your body.
- **People who are receiving medical treatment or therapy in this localized area should consult their doctor before use.**

# Parts Names

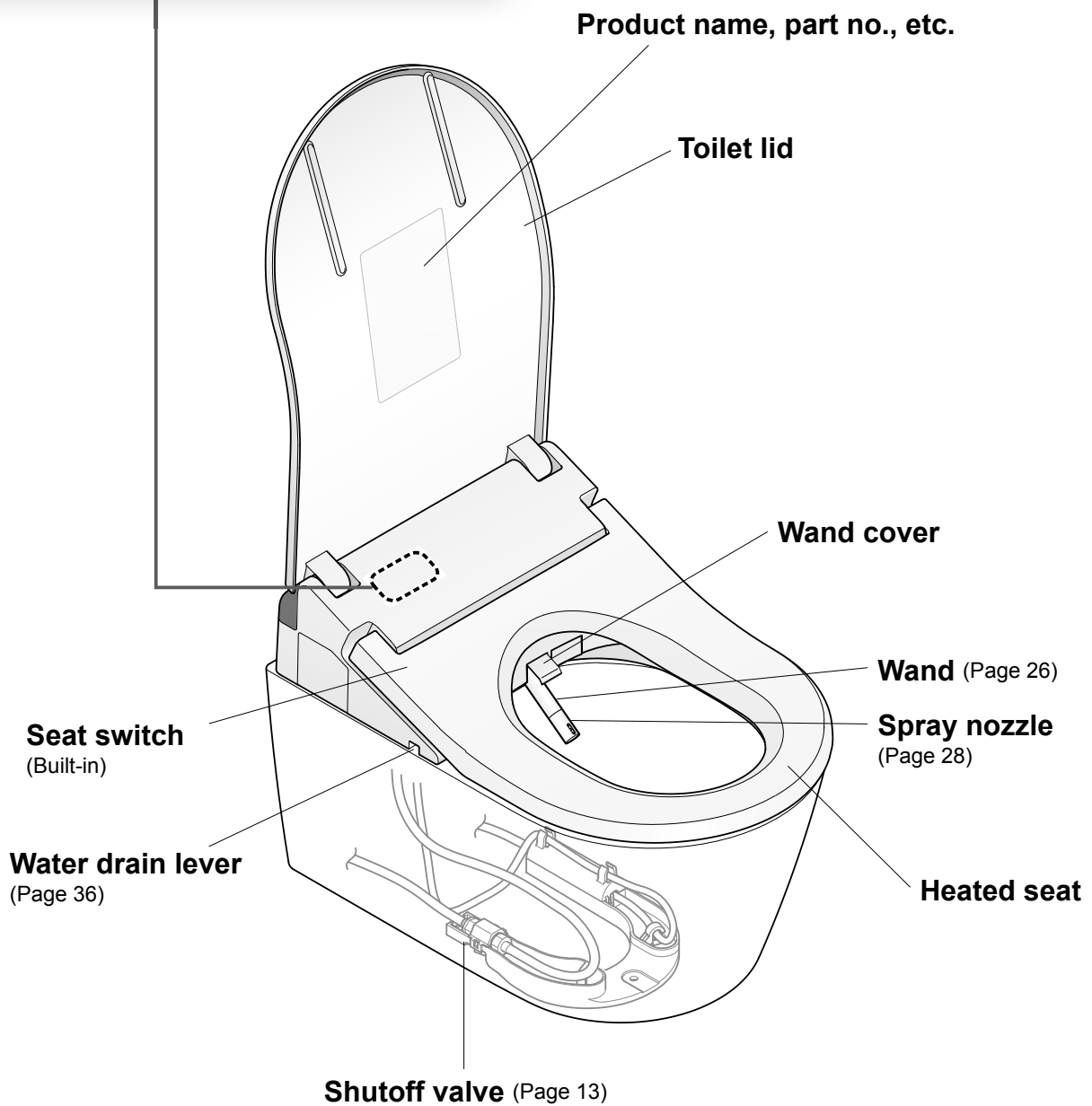
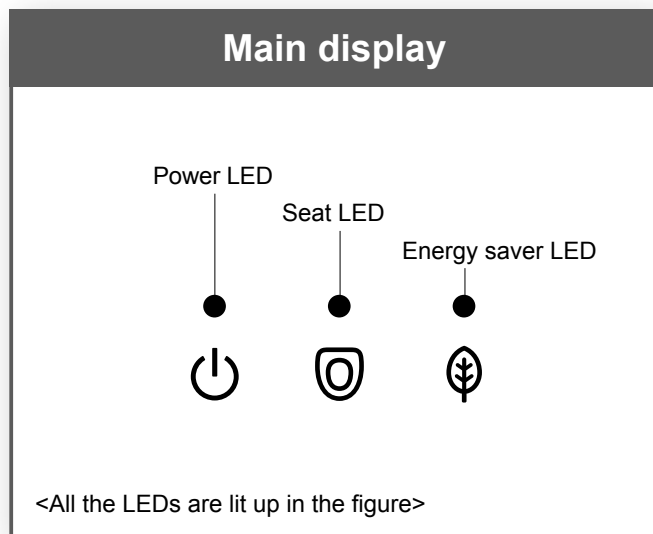

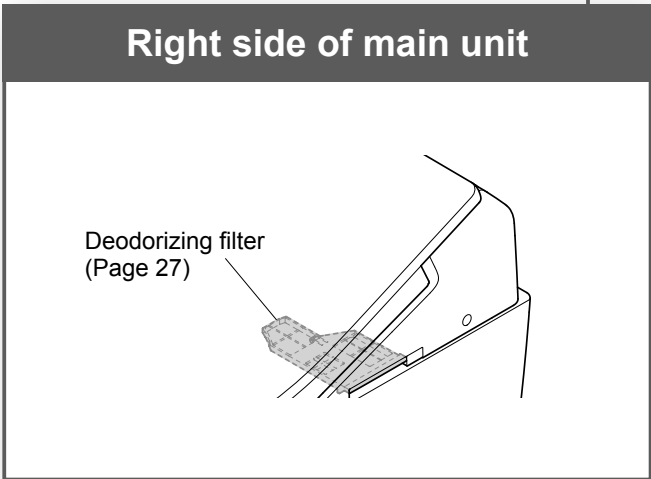
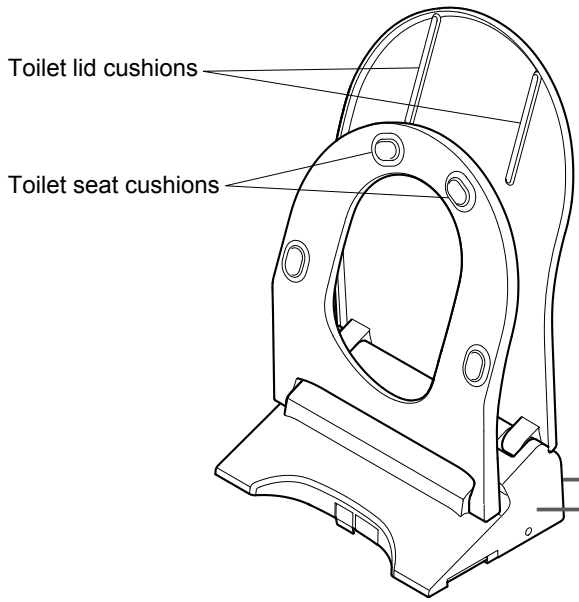
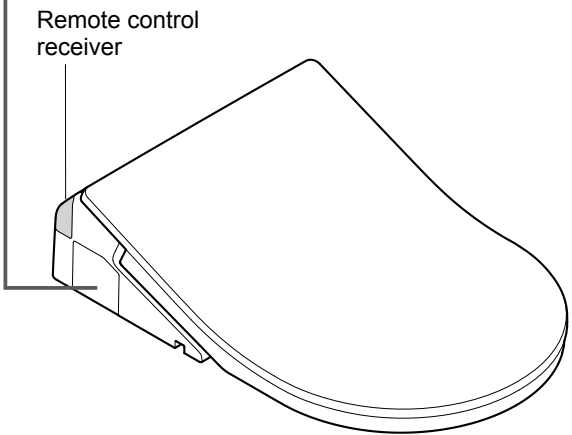
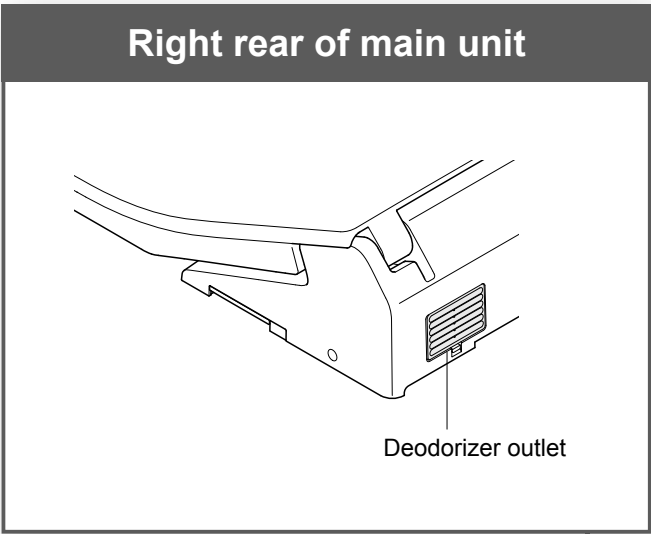
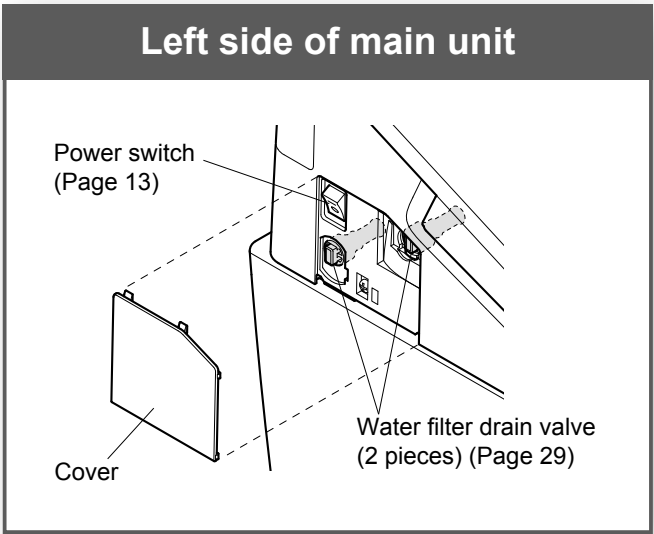

# Preparation

## Using the Product for the First Time

### 1. Insert the battery

- 1** Remove the remote control from the hanger.

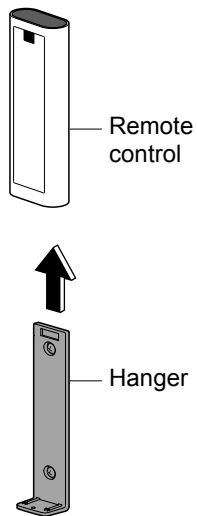

- 2** Open the battery cover and insert two AA batteries.

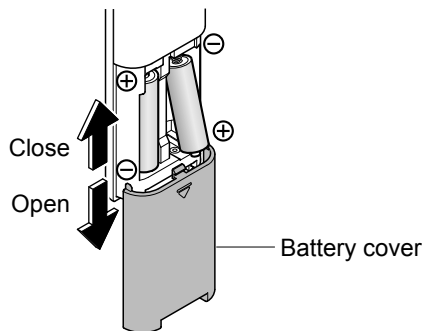

- When batteries are properly loaded, all the LEDs on the remote control light up for about 2 sec.

- 3** Mount the remote control in the hanger.

#### ■ About the batteries

- Use dry cell, alkaline batteries.
- Be sure to follow "Safety Precautions" to prevent the batteries from rupturing or leaking fluid. (Pages 6, 8)

### If the remote control is secured (for anti theft)

- 1** Remove the screw from the remote control fixture.

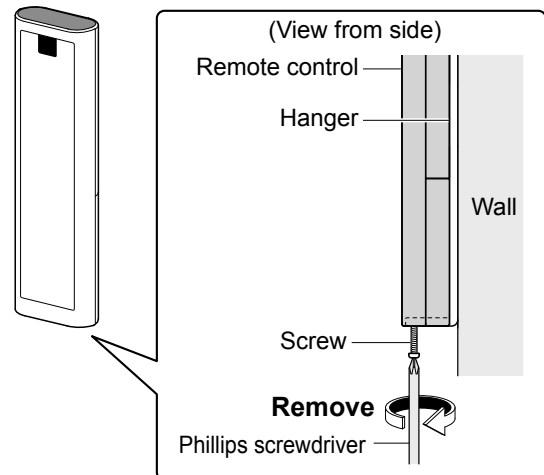

- 2** Remove the remote control from the hanger.

#### ■ To secure the remote control again

- Tighten and fix the screw.  
(Overtightening may cause damage to parts such as the hanger.)

## 2. Turn on the power

- 1 Switch the breaker on the distribution board to ON.
  - The wand extends and then retracts.
- 2 Check that the "Power" LED is lit up.

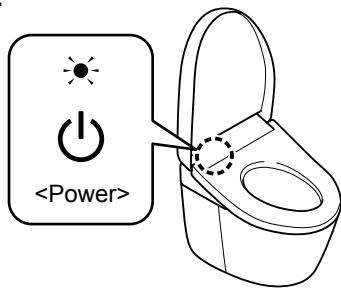

<If the light is off>

- (1) Remove the cover on the left side of the main unit, and flip the power switch to ON.

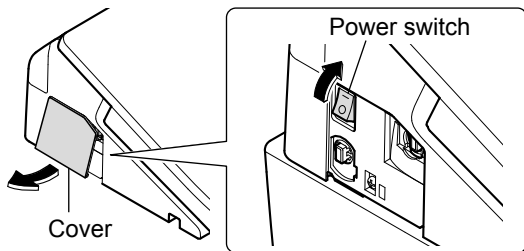

- (2) Reinstall the cover.

<If the light is off but, the power switch is "ON">

- Switch "Power" to "ON" using the remote control.

### To operate from the back of remote control

-  Press "Power ON/OFF" button about 3 seconds or longer.

### To operate from the front of remote control

- Recommended if the remote control is secured to prevent theft.
-  Press "Oscillating cleansing" button about 10 seconds or longer.

## 3. Open the shutoff valve

- 1 Fully open the shutoff valve.

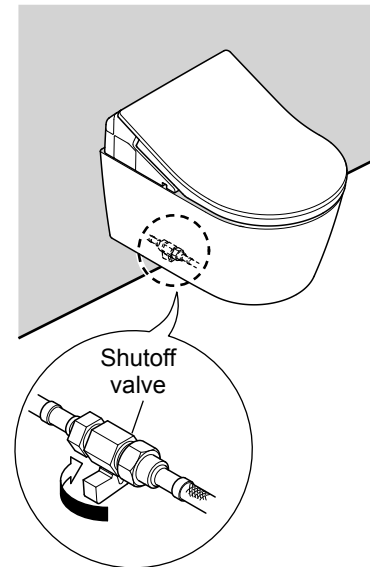

## To turn the power "OFF"

Remove the cover on the left side of the main unit, and flip the power switch to "OFF".

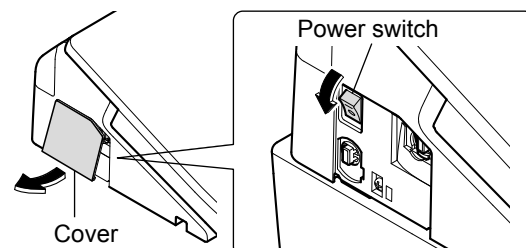

# Basic Operations

Operate the controls on the remote control; a beep sounds when the main unit receives the signal.

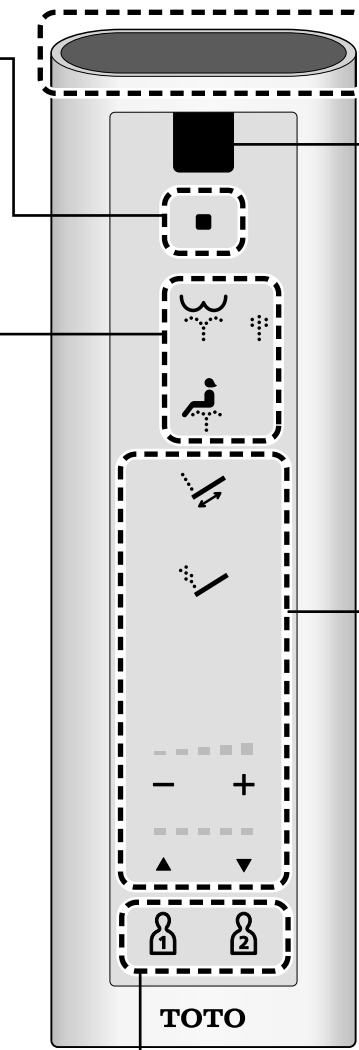

### Stopping

- "Stopping"  
Stops the operation.

### Cleansing

- 🚿 "Rear cleansing"  
Cleanses your rear.
- 🚿 "Rear soft cleansing"  
Cleanses your rear with mild water pressure.
- The setting changes between 🚿 and 🚿 each time the 🚿 is pressed.
- 🚿 "Front cleansing"  
Serves as a bidet for ladies.

- Functions that operate when a button is pressed during "Rear cleansing", "Rear soft cleansing" or "Front cleansing".

**Note**

- Sitting back on the toilet seat makes it easier to adjust the wand position and to reduce splashing.

- 🔄 "Oscillating cleansing"  
The wand moves back and forth to cleanse your rear thoroughly.
- 🔊 "Pulsating cleansing"  
Cleanses with the water pressure pulsating between soft and strong.
- The setting changes between "ON" and "OFF" each time the button is pressed.

### "Water pressure adjustment"

□ □ □ □ □

— +

You can adjust the water pressure to one of five levels.  
([-] Softer, [+] Stronger)

- After you press the "Water pressure adjustment" button, the set position will light for 10 seconds.
- A light will also flash for about 10 seconds to indicate the current setting when any of the cleansing buttons (rear cleansing, rear soft cleansing, front cleansing) are pressed.

### Personal setting lock

👤 👤 You can store your preferred "Wand position", "Water pressure" and "Warm water temperature" settings.

- To store a settings  
While cleansing is in progress, set your preferred "Wand position", "Water pressure" and "Warm water temperature" and then press and hold 1 or 2 for 2 seconds or longer.
- To use  
Press 1 or 2, and then press the button for the cleansing you want to use.
- The "Wand position" and "Water pressure" lamps will light up for about 10 seconds in their set positions, and the "Water temperature" display switches.

### "Wand position adjustment"

□ □ □ □ □

▲ ▼

You can adjust the washing position to 5 different points between the front and the rear, using the [▲] and [▼] buttons.

- After you press the "Wand position adjustment" button, the set position will light for 10 seconds.
- A light will also flash for about 10 seconds to indicate the current setting when any of the cleansing buttons (rear cleansing, rear soft cleansing, front cleansing) are pressed.

\*1 Remote control transmitter (Front side, Top side)

This section is an overview of the settings that can be configured with the remote control.

- See the corresponding pages for the detailed descriptions.

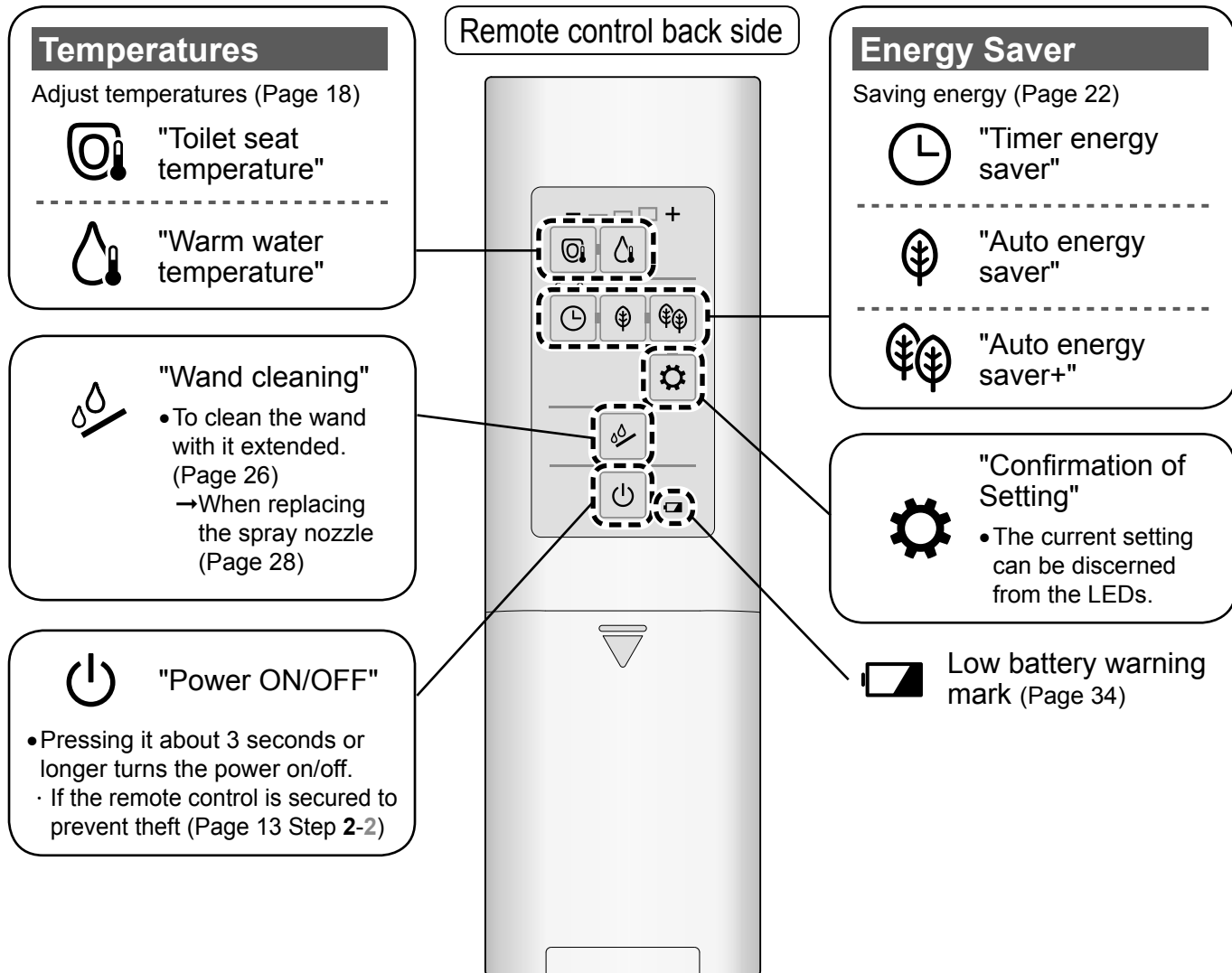

Operation

# Automatic Functions

## Cleaning Features

Various automatic functions are available.

- Operation under the initial settings is described below.

**As you approach**

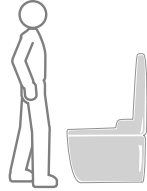

**As you sit\*1**



**As you stand up\*1**



Removing odors inside the bowl unit

### Deodorizer



**Starts the deodorizer**



**Starts the auto power deodorizer**  
(After about 10 seconds)

→It stops after about 60 seconds

A mist is sprayed inside the bowl unit to make it more difficult for dirt to adhere

### Pre-mist

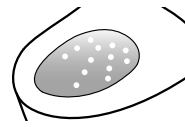

**Pre-mist**

→A mist is sprayed inside the bowl unit

\*1 Water comes out from around the wand.



## ■Note

- **Deodorizing filter needs regular maintenance.** (Page 27)

## ■Changing settings

- "Deodorizer" ON/OFF
- "Auto power deodorizer" ON/OFF  
(Page 32 for all)

- The pre-mist will not spray for about 90 seconds after you stand up from the toilet seat.

- "Pre-mist" ON/OFF  
(Page 32)

# Temperature Adjustment

Toilet Seat, Warm Water

Three different temperature levels (High / Medium / Low) and "OFF" setting can be made.

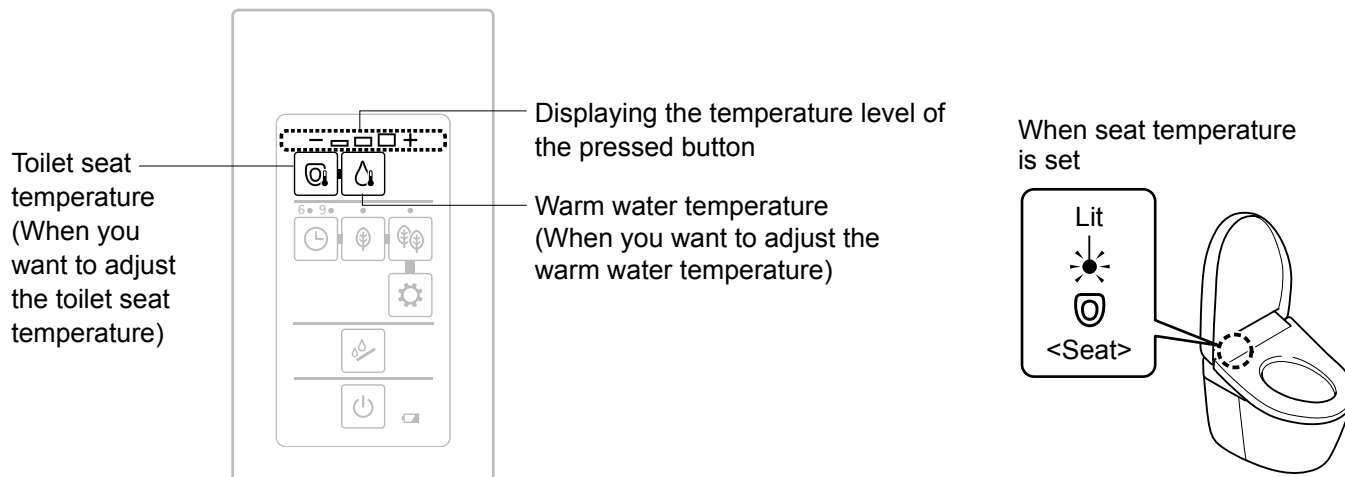

## Adjusting the temperature

- 1 Remove the remote control from the hanger.
  - If the remote control is secured to prevent theft. (Page 12)
- 2 Choose and press the button of the temperature that you want to set from the ("Toilet seat temperature" button), ("Warm water temperature" button).
  - The current temperature level appears.
- 3 Press the button selected in step 2 repeatedly until a desired temperature level lights up.

The setting changes each time the button is pressed once

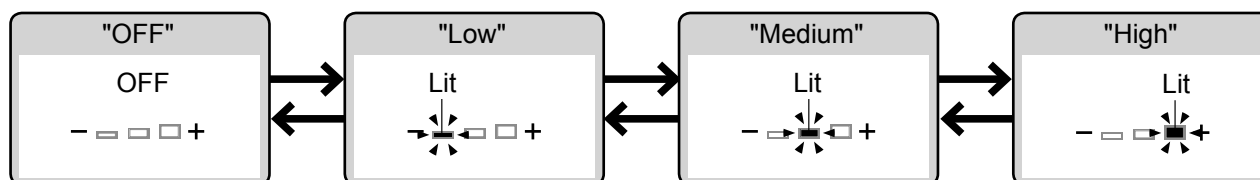

If the button is not pressed for about 10 seconds, the "Temperature adjustment" LED will go off, but the setting will be retained.

If the "Temperature adjustment" LED goes out before the setting is completed, start all over again at step 2.

<Settings complete>

- 4 Mount the remote control in the hanger.
  - If the remote control is secured to prevent theft. (Page 12)

\*1 To prevent condensation, the water temperature does not drop below 20°C even when set to "OFF".

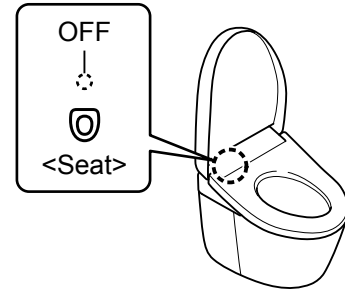

- If adjusting the temperature does not warm up the toilet seat.
  - Is the energy saver set to "ON"? (Page 20)

When seat temperature is "OFF"



## To turn the warm water temperature\*1 and toilet seat temperature "OFF"

**1** Remove the remote control from the hanger.  
 •If the remote control is secured to prevent theft. (Page 12)

**2** Select a temperature button you want to turn "OFF" from  ("Toilet seat temperature" button),  ("Warm water temperature" button) and press it.

•The current temperature level appears.

**3** Press the button selected in step **2** repeatedly until the temperature level is set to "OFF".

The setting changes each time the button is pressed once

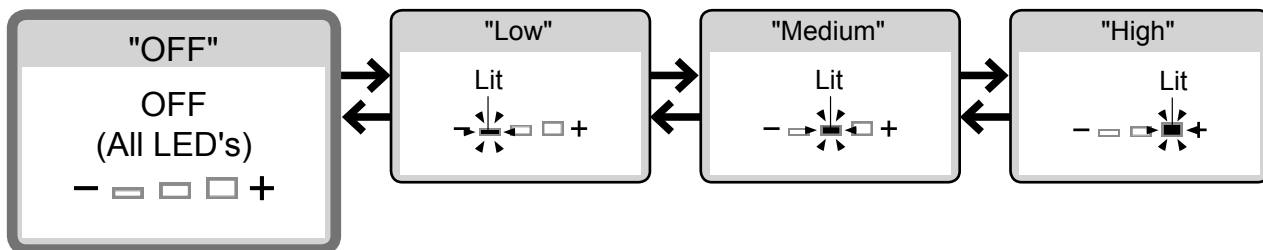

<Settings complete>

**4** Mount the remote control in the hanger.  
 •If the remote control is secured to prevent theft. (Page 12)

# Energy Saver Features

Type

"Auto energy saver", "Auto energy saver+" or "Timer energy saver" can be selected. To save energy, the temperature of the toilet seat becomes low (or "OFF").

- "Auto energy saver" takes about 10 days to detect time periods in which the toilet seat is never or infrequently used.

Type	Situation	Energy saver is on	
		Main display	
<b>Auto energy saver</b>	<p>You want the product to save energy automatically.</p> <p>The product detects time periods with infrequent use and lowers the toilet seat temperature automatically.</p>		→
<b>Auto energy saver+</b>	<p>You want to save more energy</p> <p>In addition to the "Auto energy saver" feature, it automatically turns off the toilet seat heater during time periods when the toilet is never used.</p>		→
<b>Timer energy saver</b>	<p>You want to save energy only for the preset duration of time. (6 hours / 9 hours)</p> <p>Once the time is set, the toilet seat heater turn off automatically during the set time period every day.</p>		→
<b>Timer energy saver + Auto energy saver / Auto energy saver+</b>	<p>You want to save a lot of energy with "Auto energy saver" and "Timer energy saver".</p> <p>When <b>both</b> "Timer energy saver" and "Auto energy saver / Auto energy saver+" are set, "Auto energy saver / Auto energy saver+" operates when "Timer energy saver" is not operating.</p>		

- Even if the energy saver feature is on (i.e., the toilet seat heater is set to "Low" or "OFF"), the toilet seat is heated to the set temperature in about 15 minutes.  
(The LED indication on the main display returns to the state for when the energy saver is on.)

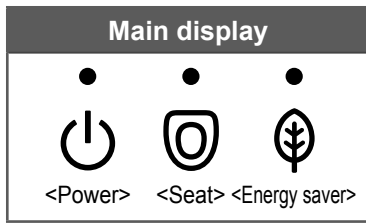

When energy saver is in operation		AM		PM				
Toilet seat heater		0	4	6	8	5	9	0
<p>Lit (Orange)</p>	<p>Low</p>	Example: Used infrequently from 9 pm to 6 am						
		Low temperature <sup>*2</sup>	Set temperature <sup>*1</sup>				Low temperature <sup>*2</sup>	
<p>Lit (Orange)</p>	<p>Low</p> <p>OFF</p>	Example: Not used from 0 am to 4 am						
		Low temperature <sup>*2</sup>	Set temperature <sup>*1</sup>				Low temperature <sup>*2</sup>	
<p>Lit (Green)</p>	<p>OFF</p>	Example: Set from 8 am to 5 pm						
		Set temperature <sup>*1</sup>	Set temperature <sup>*1</sup>				OFF <sup>*3</sup>	
<ul style="list-style-type: none"> <li>● During "Auto energy saver / Auto energy saver+": Same LED indication as "Auto energy saver / Auto energy saver+" (see above)</li> <li>● During "Timer energy saver": Same LED indication as "Timer energy saver" (see above)</li> </ul>	<p>Low</p> <p>OFF</p>	Example: When "Timer energy saver" and "Auto energy saver+" are used together						
		Low temperature <sup>*2</sup>	Set temperature <sup>*1</sup>	Set temperature <sup>*1</sup>				Low temperature <sup>*2</sup>
		OFF <sup>*3</sup>	OFF <sup>*3</sup>					

Operation

\*1 The toilet seat temperature set on page 18.

\*2 The time period when the toilet seat heater is set to a "Low".

\*3 The time period when the toilet seat heater is set to a "OFF"

To set energy saver Page 22 and 23

# Energy Saver Features

## How to Set

Remote control back side

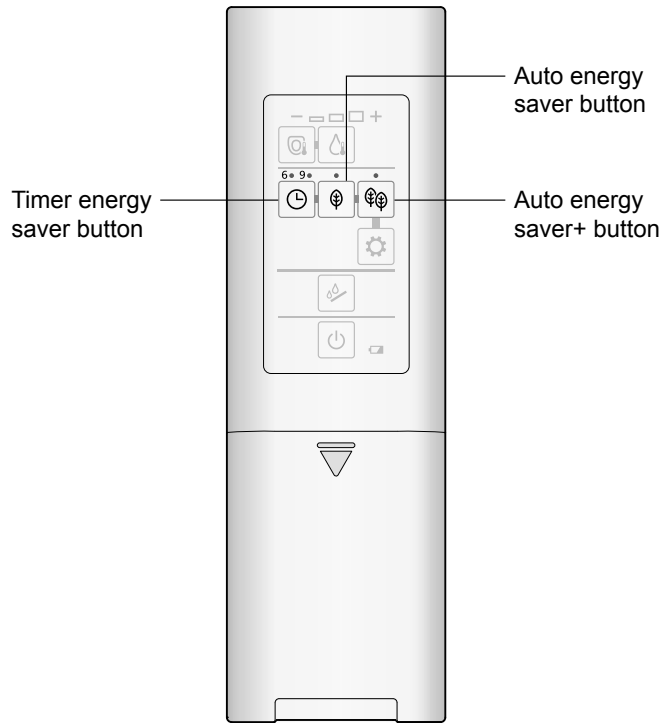

Auto energy saver

Auto energy saver+

Timer energy saver

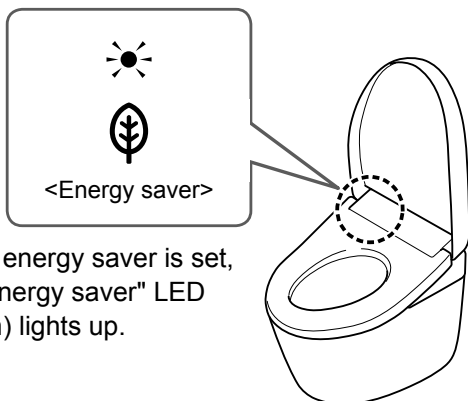

**1**  Press "Auto energy saver" button.

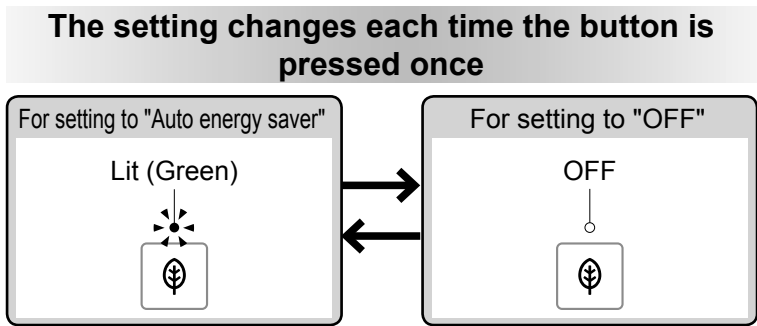

**1**  Press "Auto energy saver+" button.

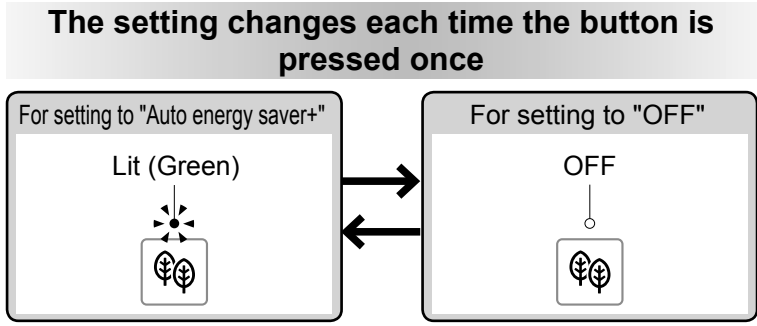

● Set the Energy saver at the time you want to start it.

Example: To save energy from 1 am to 7 am (for 6 hours)

**1**  When 1:00 AM comes, Press "Timer energy saver" button.

• Press the "Timer energy saver" button repeatedly until the "6" LED lights up.

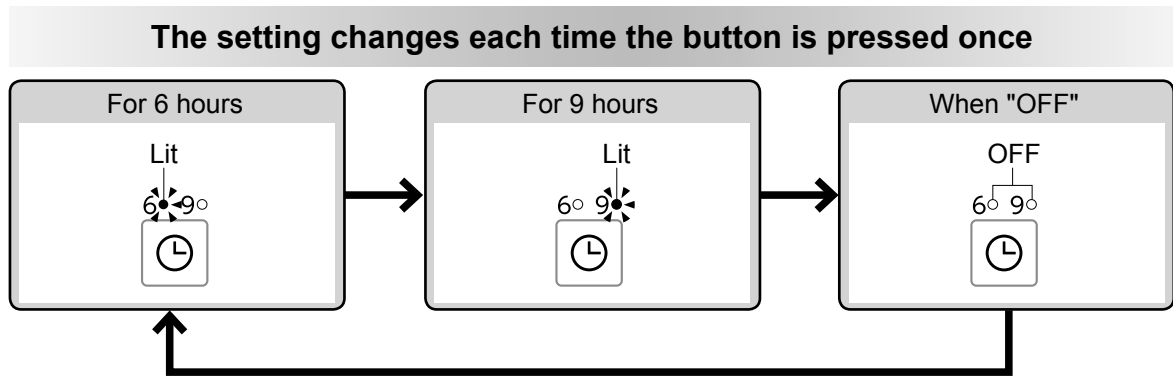

# Maintenance

## ⚠ CAUTION



**Always flip the power switch to OFF before cleaning or maintenance.**  
(Failure to do so may cause electric shock or malfunction, resulting in a breakdown.)

**For safety, flip the power switch to OFF  
before cleaning or maintenance.\*1**

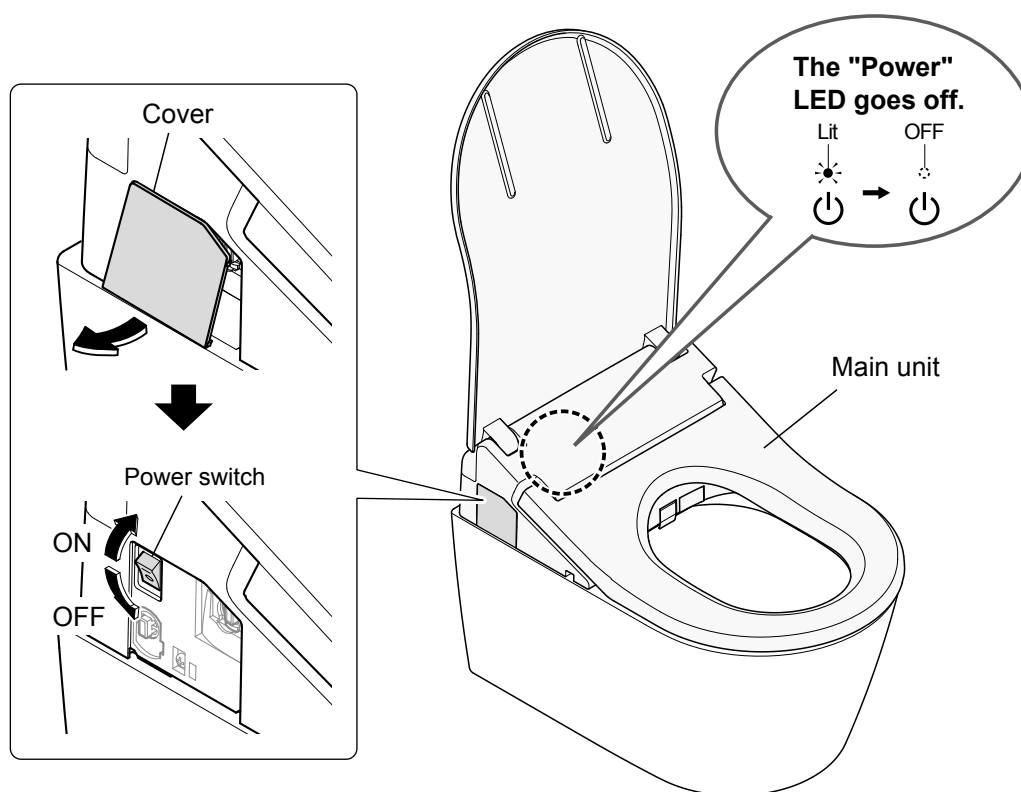

Do not use a dry cloth or toilet paper on plastic parts.  
(May cause damage.)

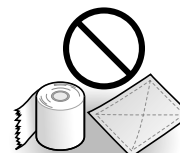

\*1 Except when using "Wand cleaning".



# Main Unit

## Main Unit (Approximately daily)



**1** Remove the cover on the left side of the main unit, and flip the power switch to "OFF". (Page 24)

**2** Wipe with a soft cloth that has been soaked in water and wrung-out thoroughly.

■ **For heavy dirt**

- Wipe with a soft cloth soaked in diluted, neutral kitchen detergent, and then wipe with a soft cloth soaked in water.



**3** Flip the power switch to ON. (Page 24)

- The "POWER" LED lights up.

**4** Reinstall the cover.

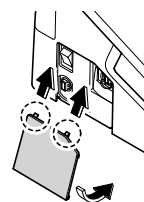

**Attention!**

- This product is an electric appliance. Be careful not to let water seep inside or leave detergent in the gap between the main unit and bowl unit. (May damage plastic parts or cause a malfunction.)
- When using a toilet cleaner to clean the toilet, rinse it off within 3 minutes and leave the toilet seat and toilet lid open.
  - Wipe off any cleaner that remains on the bowl unit. (If vapor from a toilet cleaner enters the main unit, it may cause a malfunction.)
- Do not push or pull the covers around the wand with undue force. (May cause damage or malfunction.)
- Wipe the back surface of the toilet seat and the toilet seat cushions with a soft cloth tightly wrung out with water.  
(Otherwise adhesion of dirt may result in discoloration.)

# Maintenance Wand

## Wand (Approximately once a month) <If you notice dirt (Wand cleaning)>



Soft cloth

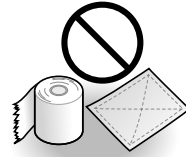

Toilet paper, etc.  
(May cause damage.)

**1**

### Extend the wand.

**To operate from the back of remote control**



Press "Wand cleaning" button.

**To operate from the front of remote control**

• Recommended if the remote control is secured to prevent theft.

- (1) ■ Press "Stopping" button until all LEDs on the remote control start flashing.  
(about 10 seconds)
- (2)  Press "Front cleansing" button about 3 seconds or longer.

**2**

### Wipe with a soft, wet cloth.

- Do not pull, push or press the wand with excessive force.  
(May cause malfunctions or damage.)

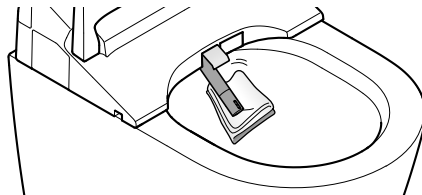

**3**

### ■ Press "Stopping" button on the front side of the remote control.

- The wand retracts.
- Water comes out from around the wand.

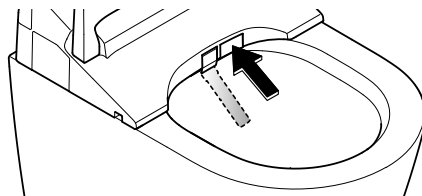

## Deodorizing Filter

### Deodorizing Filter (Approximately once a month)

**1** Remove the cover on the left side of the main unit, and flip the power switch to "OFF". (Page 24)

**2** Remove the deodorizing filter.  
• Hold the knob and pull outward.  
• Do not pull with undue force. (May cause damage or malfunction.)

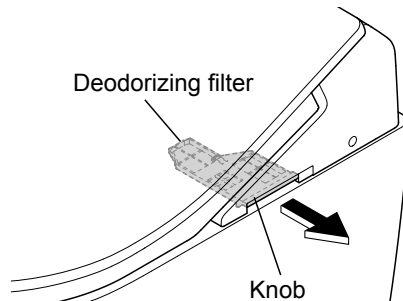

**3** Clean with a tool such as a toothbrush.  
• When washing with water, dry off all water before mounting.

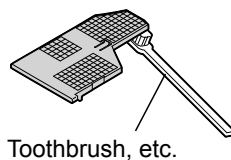

**4** Mount the deodorizing filter.

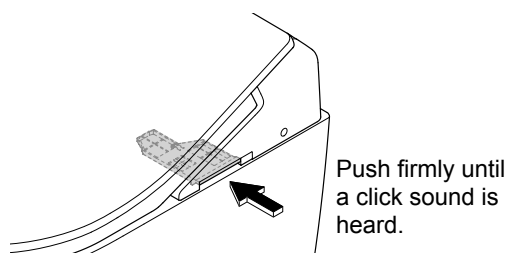

**5** Flip the power switch to ON. (Page 24)  
• The "Power" LED lights up.

**6** Reinstall the cover. (Page 25)

# Maintenance

## Spray Nozzle

### 1. Spray Nozzle

< If you think the water pressure has weakened >



General lime scale remover  
(liquid)



Other detergents

**1**

Remove the spray nozzle from the wand.

(1) Extend the wand.

(Step **1** page 26)

(2) While holding the wand with a hand, press on both sides of the spray nozzle and slide it.

- Do not pull with undue force.  
(May cause damage or malfunction.)

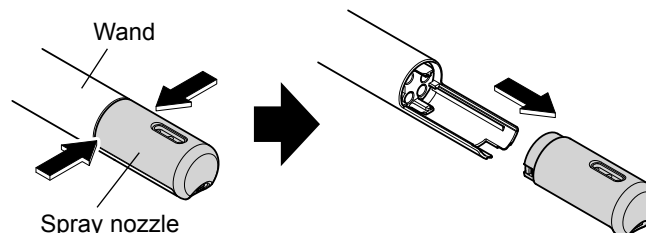

**2**

Install a spray nozzle (for replacement).

Check that the gasket (black) is attached.



(1) Hold the wand by hand and slide the replacement spray nozzle along the guide and push it in.

- Install correctly until a click sound is heard.
- Do not push with undue force. (May cause damage or malfunction.)

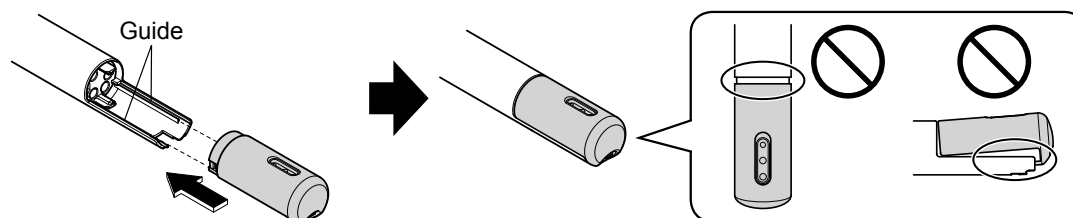

(2) ■ Press "Stopping" button on the front side of the remote control.

- The wand retracts.
- Water comes out from around the wand.

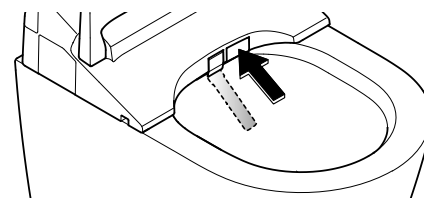

**Attention!**

- Keep the spare nozzle in safe place.

### Cleaning the blocked Nozzle

Remove the spray nozzle and immerse it in general lime scale remover (liquid).

- Do not disassemble the spray nozzle. (May cause malfunctions.)

# Water Filter Drain Valve

## 2. Water Filter Drain Valve (Approximately once every 6 months)

<The water pressure is still weak even after cleaning the spray nozzle>

- 1** Close the shutoff valve. (Page 39)  
• The water supply stops.

### CAUTION

 Do not remove the water filter drain valve while the shutoff valve is open.  
(Otherwise, water may leak out)

- 2** After extending the nozzle (see process **1** on page 26),  
■ press "Stopping" button to retract it.

(Release the pressure from the water supply pipe.)

- Water comes out from around the wand.

- 3** Remove the cover on the left side of the main unit, and flip the power switch to "OFF".

(Page 24)

- 4** Remove the two water filter drain valves.

- Loosen the water filter drain valve with a flat-head screwdriver and then pull it.

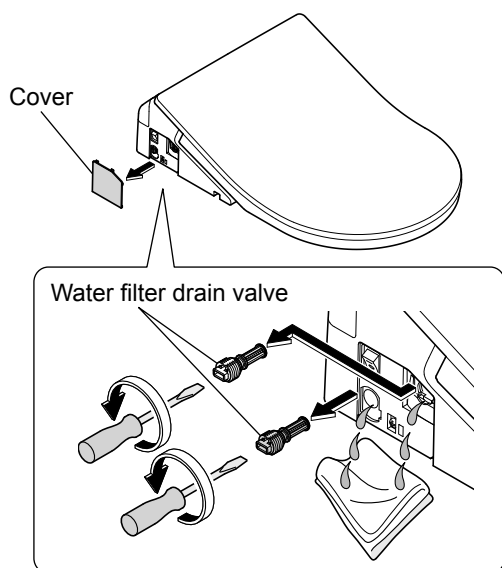

- 5** Clean the filter with a tool such as a toothbrush.

- Also, remove any dust from inside the hole of the water filter drain valve.

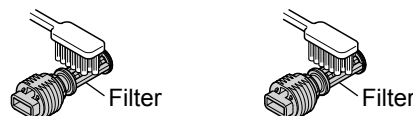

- 6** Reinstall the two water filter drain valves.

- Insert the water filter drain valve and use a flat-head screwdriver to tighten it securely.

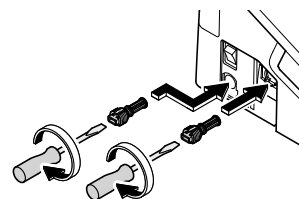

- 7** Flip the power switch to ON.  
(Page 24)

- The POWER LED lights up.

- 8** Reinstall the cover. (Page 25)

- 9** Open the shutoff valve.  
(Page 13)

# Changing Settings

## Setting List

Setting Types		
Auto functions	Cleaning Features	Pre-mist
		Deodorizer
		Auto power deodorizer
Other settings	Beep sound	
	Personal setting lock	

To change the settings, check that all LEDs on the control panel are flashing!<sup>\*1</sup>

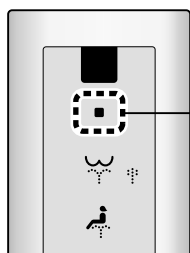

■ Press "Stopping" button about 10 seconds or longer.



All LEDs on the control panel flash.<sup>\*1</sup>

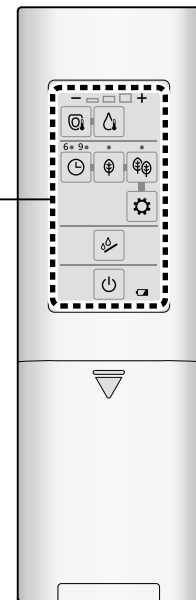
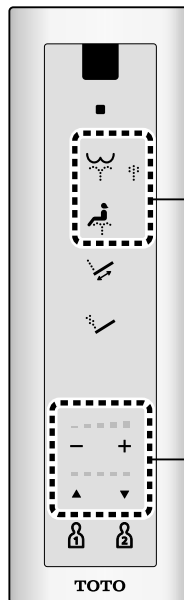

Settings cannot be changed unless all LEDs flash

		Available Settings Bold: Initial settings	How to Set Ref. Page
	• Set whether or not to <b>spray mist in the bowl unit automatically</b>	ON/OFF	Page 32
	• Set whether or not to <b>deodorize automatically after sitting on the toilet seat</b>	ON/OFF	
	• Set whether or not to <b>power deodorize automatically after standing up</b>	ON/OFF	
	• Set whether or not to <b>make a beep sound</b>	ON/OFF	Page 32
	• Set whether or not to <b>use the personal setting lock</b>	ON/OFF	

\*1 During setting, if the next button is not pressed within about 60 seconds, the light will stop flashing. If you fail to complete the setting, redo from the step 1.

# Changing Settings

- Press "Stopping" button until all LEDs on the remote control start flashing. (about 10 seconds)

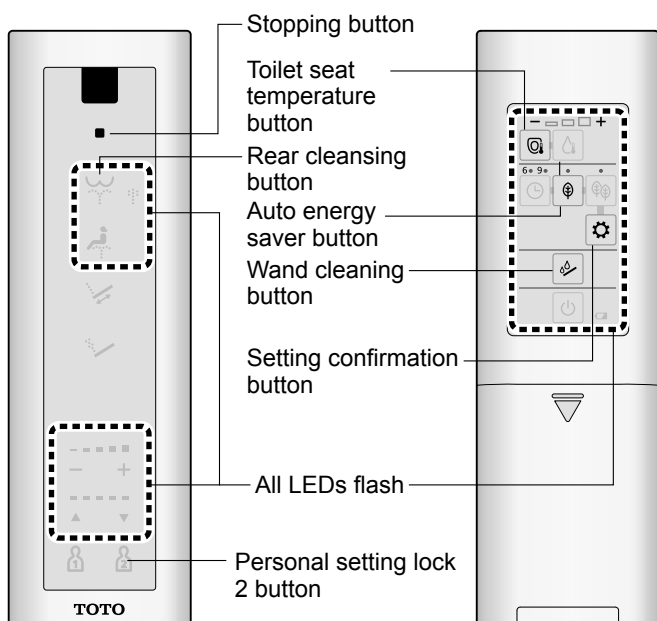

## Cleaning Features

Set whether or not to spray mist in the bowl unit automatically

### Pre-mist

Set whether or not to deodorize automatically after sitting on the toilet seat

### Deodorizer

Set whether or not to power deodorize automatically after standing up

### Auto power deodorizer

## Other settings

Set whether or not to make a beep sound

### Beep sound\*1

Set whether or not to use the personal setting lock

### Personal setting lock



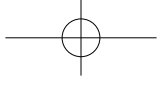

2

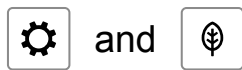

Press "Setting confirmation" button and "Auto energy saver" button at the same time.

The setting changes each time the button is pressed once

Set whether or not to spray mist in the bowl unit automatically

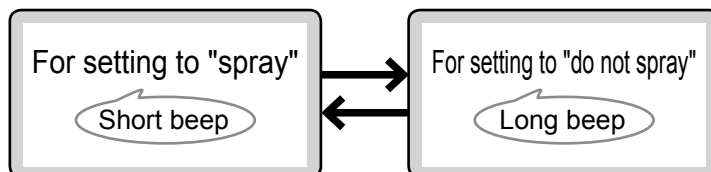

2



Press "Wand cleaning" button about 5 seconds or longer.

The setting changes each time the button is held down longer than 5 seconds.

Set whether or not to deodorize automatically after sitting on the toilet seat

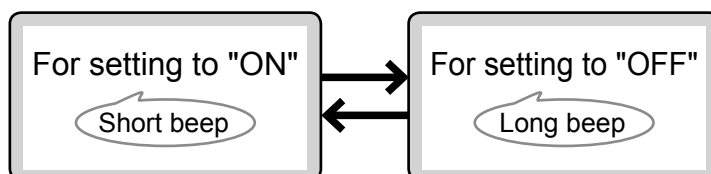

2



Press "Toilet seat temperature" button.

The setting changes each time the button is pressed once

Set whether or not to power deodorize automatically after standing up

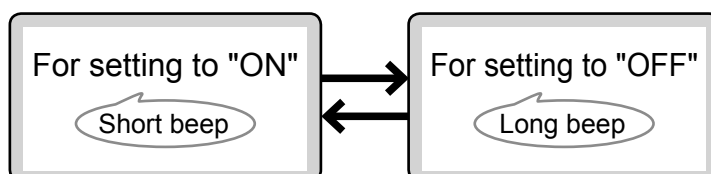

3

Press "Stopping" button.  
<Settings complete>

2



Press "Rear cleansing" button.

The setting changes each time the button is pressed once

Set whether or not to make a beep sound

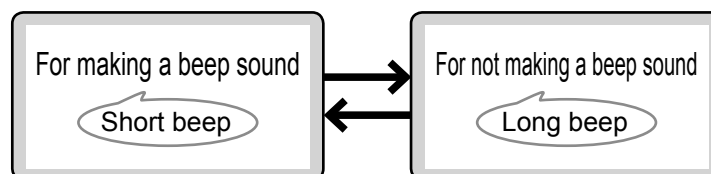

2



Press "Personal setting lock 2" button for 5 seconds or longer.

The setting changes each time the button is held down longer than 5 seconds.

Set whether or not to use the personal setting lock

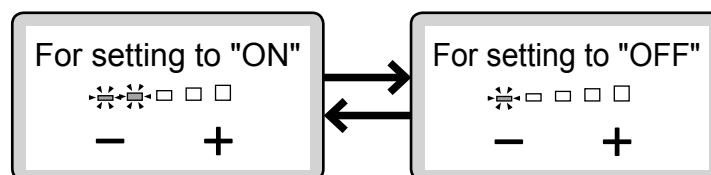

Check by the water pressure LED

3

Press "Stopping" button.  
<Settings complete>

Reference

\*1 When you change each of the settings, set the electronic sound to "Make a beep sound".

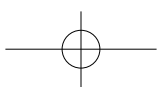

# What to Do?

**If the water does not flow due to a water service interruption**

**If you cannot operate with the remote control**

**If the water does not flow due to a water service interruption**

**1** Use a bucket to flush water.

**2** If the water level is low after flushing, add more water.

- Prevents odors.

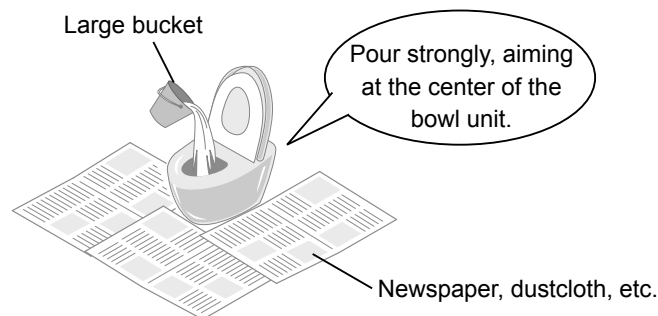

**Attention!**

- When the water supply is restored, be sure to perform a flush. (To prevent waste from remaining in the drain pipe.)

**If you cannot operate with the remote control**

- If the low battery warning mark "  " on the back of the remote control is flashing, please replace the batteries.

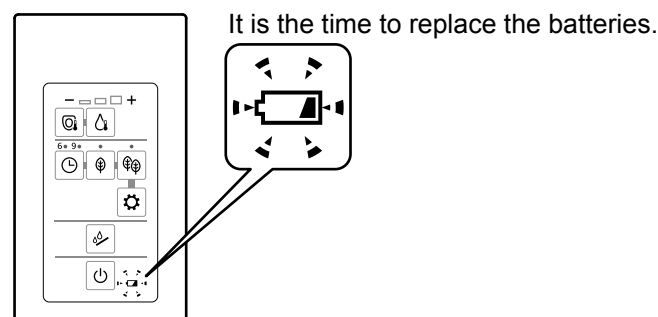

## ■ Replacing the batteries

**1** Remove the cover on the left side of the main unit, and flip the power switch to "OFF". (Page 13)

**2** Remove the remote control from the hanger. (Page 12)

**3** Open the battery cover and replace the two AA batteries. (Page 12)

- The low battery warning mark goes off.

**4** Mount the remote control in the hanger.

**5** Flip the power switch to ON. (Page 13)

- The "Power" LED lights up.

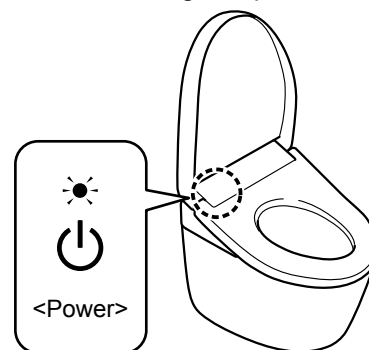

**6** Reinstall the cover. (Page 25)

**Attention!**

- "ON" and "OFF" settings of the functions such as the energy saver function may be canceled when the batteries are replaced. Set them again.

# Freeze Damage Prevention

When the ambient temperature is likely to drop to 0°C or lower, take measures to prevent freezing.

## Attention!

- When the ambient temperature is likely to drop to 0°C or lower, do not use the energy saver feature. (May damage the product.)
- Warm the bathroom or take measures against freezing so that the ambient temperature does not drop below 0°C.

## How to freeze damage prevention

1

Close the shutoff valve. (Page 39)

- The water supply stops.

**CAUTION**

 **Do not remove the water filter drain valve while the shutoff valve is open.**  
(Otherwise, water may leak out.)

2

Extend the wand.

(Release the pressure from the water supply pipe.)

### To operate from the back of remote control

- (1)  Press "Wand cleaning" button.
- (2) ■ Press "Stopping" button on the front side of the remote control.
  - The wand retracts.

### To operate from the front of remote control

- Recommended if the remote control is secured to prevent theft.
- (1) ■ Press "Stopping" button until all LEDs on the remote control start flashing. (about 10 seconds)
  - (2)  Press "Front cleansing" button about 3 seconds or longer.
  - (3) ■ Press "Stopping" button on the front side of the remote control.
    - The wand retracts.

3

Remove the cover on the left side of the main unit, and flip the power switch to "OFF". (Page 13)

4

Remove the two water filter drain valves.

- Loosen the water filter drain valve with a flat-head screwdriver and then pull it.

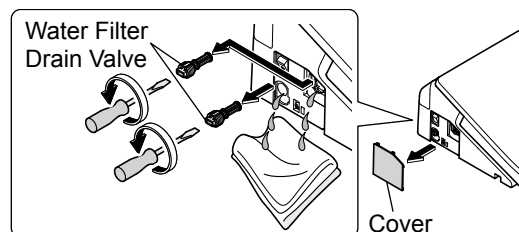

5

Reinstall the two water filter drain valves.

- Insert the water filter drain valve and use a flat-head screwdriver to tighten it securely.

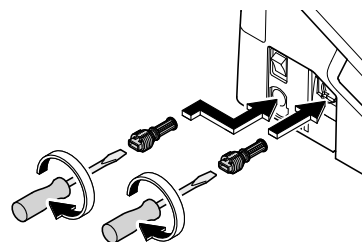

6

Flip the power switch to ON. (Page 13)

- The "Power" LED lights up.

7

Reinstall the cover. (Page 25)

8

Set the toilet seat temperature to "High". (Page 18)

- To maintain the temperature, close the toilet seat and toilet lid after finishing work.

### ■ To use the product again

- The water needs to be resupplied. (Page 37)

# What to Do?

## Long Periods of Disuse

If the toilet is in a location you will not visit for a long time, drain the water.

(The water in the tank may cause malfunctions or become contaminated and cause skin irritation or other problems.)  
(May cause freezing and damage to product.)

### How to drain the water

1

Close the shutoff valve. (Page 39)

- The water supply stops.

#### CAUTION



-  Do not remove the water filter drain valve while the shutoff valve is open. (Otherwise, water may leak out.)

2

Extend the wand.



(Release the pressure from the water supply pipe.)

#### To operate from the back of remote control

- (1)  Press "Wand cleaning" button.
- (2)  Press "Stopping" button on the front side of the remote control.
  - The wand retracts.

#### To operate from the front of remote control

- Recommended if the remote control is secured to prevent theft.

- (1)  Press "Stopping" button until all LEDs on the remote control start flashing. (about 10 seconds)
- (2)  Press "Front cleansing" button about 3 seconds or longer.
- (3)  Press "Stopping" button on the front side of the remote control.
  - The wand retracts.

3

Remove the cover on the left side of the main unit, and flip the power switch to "OFF". (Page 13)

4

Remove the two water filter drain valves.

- Loosen the water filter drain valve with a flat-head screwdriver and then pull it.

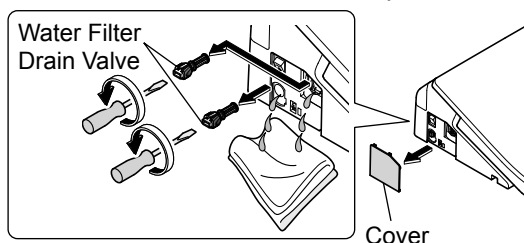

5

Reinstall the two water filter drain valves.

- Insert the water filter drain valve and use a flat-head screwdriver to tighten it securely.

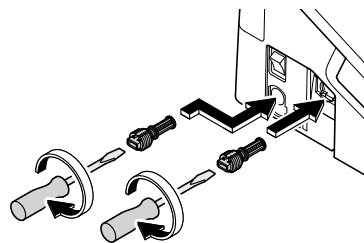

6

Reinstall the cover. (Page 25)

7

Pull out the water drain lever.

- Water comes out from around the wand. (about 20 seconds)

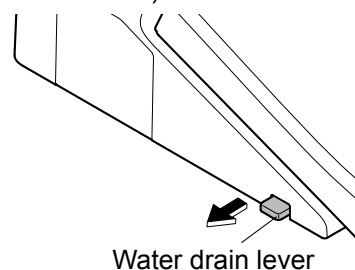

8

Release your hand to return the water drain lever to its original position.

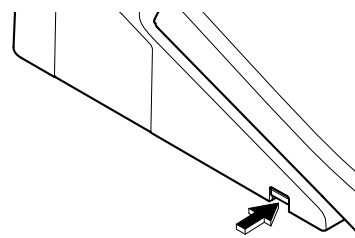

#### ■ If water may get frozen

- Add antifreeze solution in the water in the bowl to prevent freezing. (The antifreeze solution should not be flushed out. Collect it before using the toilet and dispose of it.)

#### ■ To use the product again

- The water needs to be resupplied. (Page 37)

## Resupplying the Water

1

Open the shutoff valve. (Page 13)

- Check that water is not leaking from a pipe or the main unit.

2

If the power is not on,

Remove the cover on the left side of the main unit, and flip the power switch to "ON". (Page 13)



- The "Power" LED lights up.

3

Reinstall the cover. (Page 25)

4

Discharge water from the wand.

- (1) Pressing down the left side of the toilet seat,
- (2)  Press "Rear cleansing" button on the remote control to discharge water from the wand.
  - Catch the water in a paper cup or other receptacle.
- (3)  Press "Stopping" button.

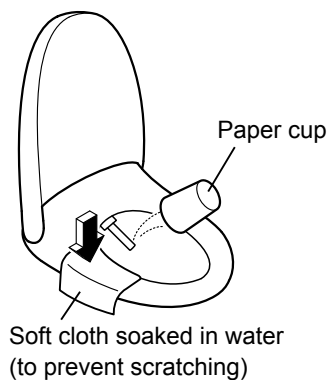

■ **If the remaining water has frozen and no water comes out**

- Heat the inside of the bathroom, and warm the water supply hose and shutoff valve using a cloth soaked in warm water.

# What to Do?

## Removal of Operation Guide

To remove, follow the procedure below.

### How to remove the operation guide

- 1** Remove the cover on the left side of the main unit, and flip the power switch to "OFF". (Page 13)
- 2** Remove the remote control from the hanger. (Page 12)
- 3** Remove the hanger and operation guide.

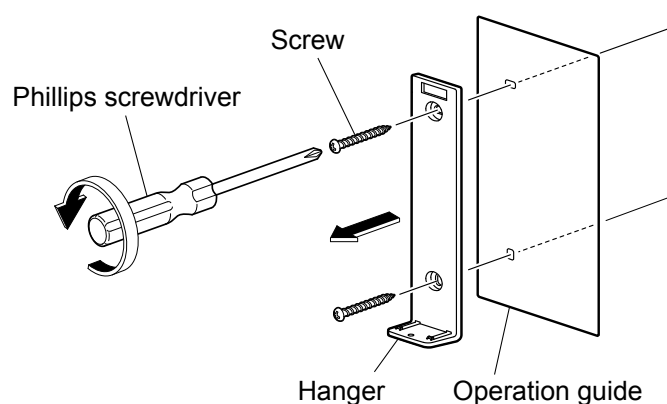

- 4** Screw the hanger on the wall.

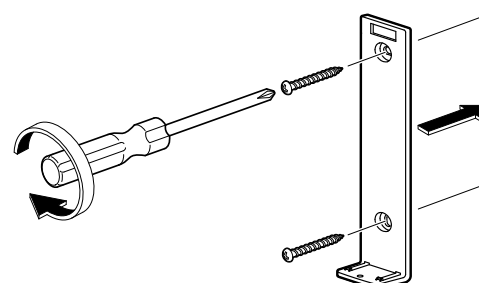

- 5** Mount the remote control in the hanger.
- 6** Flip the power switch to ON. (Page 13)
  - The "Power" LED lights up.
- 7** Reinstall the cover. (Page 25)

■ To install back the operation guide, follow the procedure above.  
(Install the operation guide at step 4.)

# Troubleshooting

First, try the actions described on pages 39 to 42.  
If the problem persists, consult the installer, seller, or TOTO customer service (see contact information on the back cover).

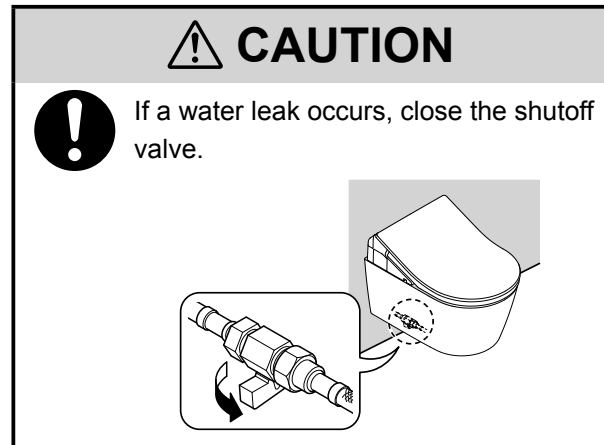

## Please check first

### Is the Power LED lit?

- **Is the breaker on the distribution board turned on?**  
→ Check whether there is a power outage or the breaker has turned "OFF".
- **Is the power switch flipped to "OFF"?**  
→ Flip it to "ON". (Page 13 Step 2-2)
- **Is the "Power ON/OFF" setting "OFF"?**  
→ Switch it to "ON" with the remote control. (Page 13 Step 2-2)

### Is the Energy saver LED lit?

- **While the LED is lit, energy saver (Page 20) is in operation, so the toilet seat temperature may be reduced or the heater may be turned off.**

### Is the remote control working?

- **Is the "  " LED on the backside of the remote controller flashing?**  
→ Replace the batteries. (Pages 34)
- **Is the remote control transmitter or the remote control receiver blocked?**  
→ Remove obstructions, dirt, water droplets or any other blockages.

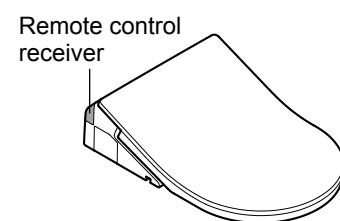
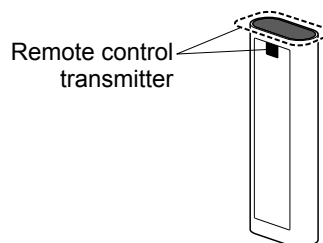
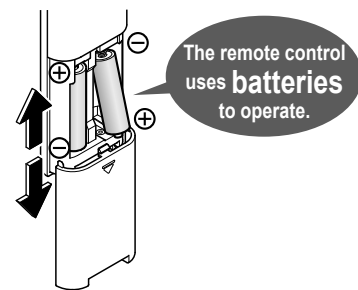

# Troubleshooting

## Rear Cleansing, Front Cleansing and Wand

Trouble	Please check	Ref. Page
<b>The wand (or cleansing water) does not come out</b>	<ul style="list-style-type: none"> <li>● When the temperature is low, it takes time for the wand to come out after the remote control button is pressed because the water must be warmed up first.</li> </ul>	-
	<ul style="list-style-type: none"> <li>● Did you sit on the toilet continuously for 2 hours or longer? (If so, operation is stopped for safety purposes.) → Stand up from the seat and then use again.</li> </ul>	-
	<ul style="list-style-type: none"> <li>● If the water supply pressure drops significantly, for example if water is used elsewhere or if there is a water failure, the function may stop for safety. → Flip the power switch to OFF and wait about 10 seconds before flipping it on again. If the same symptom reappears. → There may be a malfunction. Consult with TOTO customer service (see contact information on the back cover).</li> </ul>	13
	<ul style="list-style-type: none"> <li>● The seat switch will not turn on unless you sit on the seat properly. → Sit back on the toilet seat.</li> </ul>	9
	<ul style="list-style-type: none"> <li>● Are you using a toilet seat cover, a toilet lid cover or a seat for infants? → Remove any covers. When using a seat for infants or a soft highchair, remove after each use.</li> </ul> 	9
<b>The wand extends but the cleansing water does not come out / The cleansing water pressure is weak</b>	<ul style="list-style-type: none"> <li>● Has a water failure occurred? → ■ Press "Stopping" button on the remote control and wait until water service is restored.</li> </ul>	-
	<ul style="list-style-type: none"> <li>● Is the shutoff valve closed? → Fully open the shutoff valve.</li> </ul>	13
	<ul style="list-style-type: none"> <li>● Is the wand or filter clogged with foreign matter? → Clean the spray nozzle, water filter drain valve and water drain plug.</li> </ul>	28 29
	<ul style="list-style-type: none"> <li>● Is the water pressure set to a low level?</li> </ul>	14
<b>The cleansing water is cold</b>	<ul style="list-style-type: none"> <li>● Is the warm water temperature set to "OFF" or a low level?</li> <li>● When the temperature of the water supply or the bathroom is low, the water temperature may be low when first sprayed.</li> </ul>	18 -
<b>Stops in the middle of use</b>	<ul style="list-style-type: none"> <li>● "Rear cleansing", "Rear soft cleansing" and "Front cleansing" stop automatically after 5 minutes of continuous use. Then the POWER LED (Green) and the ENERGY SAVER LED (Green) on the display of the main unit flash about 60 seconds while hot water is prepared. → Wait until the LEDs on the display of the main unit light up solidly and then press the button again.</li> <li>● Does the seat switch have difficulty detecting? → Sit back on the toilet seat. If you get up slightly from the seat, or sit forward on the seat, the seating switch may temporarily stop detecting your presence.</li> </ul>	- 9
<b>Water comes out unexpectedly from the wand</b>	<ul style="list-style-type: none"> <li>● Water comes out from the area around the wand for several seconds after you sit on and stand up from the toilet seat.</li> </ul>	-



## Toilet Seat and Toilet Lid

Trouble	Please check	Ref. Page
<b>The toilet seat is cold</b>	● Is the toilet seat temperature set to "OFF" or a low level?	18
	● Is energy saver in operation? <ul style="list-style-type: none"> <li>• The energy saver feature is on when the "Energy saver" LED is on and the "Power" LED is off on the main display.</li> </ul> When you sit on the seat, the toilet seat heater is turned on temporarily and the seat is warmed in about 15 minutes. → You can turn it "OFF" if the energy saver feature is "ON".	20 22
	● Have you been seated for a long time? <ul style="list-style-type: none"> <li>• After about 20 minutes of sitting, the temperature starts going down, and after about 1 hour, the toilet seat heater is turned "OFF".</li> </ul> → Stand up from the seat and then use again.	-
	● The seat switch will not turn on unless you sit on the seat properly. → Sit back on the toilet seat.	9
	● Is a toilet lid or seat cover installed? → Remove any covers.	9

## Energy Saver

Trouble	Please check	Ref. Page
<b>The Energy saver LED does not light up</b>	● Did you flip the power switch to OFF, or was there a power outage? <ul style="list-style-type: none"> <li>• The "Energy saver" LED on the main display may go off when the power is turned on even if the energy saver feature is "ON".</li> </ul> (It will turn on within about 24 hours since the setting is retained.)	-
<b>The timer energy saver feature is not working</b>	● Did you replace the remote control batteries? <ul style="list-style-type: none"> <li>• "Timer energy saver" may be canceled when the batteries are replaced.</li> </ul> → Set the timer energy saver again at the time you want to start it.	22
<b>The auto energy saver+ or auto energy saver feature is not working</b>	● Because the function takes several days learning the usage conditions before starting energy saver, the amount of energy saving may be low, depending on the frequency of use. → Check the energy saver setting.	20

# Troubleshooting

## Deodorizer

Trouble	Please check	Ref. Page
The deodorizer seems to be not working	● Is "Deodorizer" set to "OFF"? → Set to "ON".	32
	● Even after sitting down, you do not hear operation sounds. → Sit back on the toilet seat. If you hear an operation sound from the deodorizer, but odours are not removed. → Clean the deodorizing filter.	9 27
	● Are you using an air freshener or deodorizer that you purchased separately? • Doing so may reduce the effectiveness of the product deodorizer or cause strange odors. → Remove the air freshener or deodorizer.	-
The auto power deodorizer feature is not working	● Is "Auto power deodorizer" set to "OFF"? → Set to "ON". ● It starts about 10 seconds after you stand up from the toilet seat.	32 -

## Others

Trouble	Please check	Ref. Page
Water is leaking from the plumbing connections	● If any nuts in a connection are loose, firmly tighten them with a tool such as a monkey wrench. → If the water leak does not stop, close the shutoff valve and consult with TOTO customer service (see contact information on the back cover).	-
The main unit is unstable	● There is clearance between the toilet seat cushion and the bowl unit for activating the seat switch. When you sit on the toilet seat, the toilet seat subsides slightly to activate the seat switch.	9
The main unit makes a sound	When the toilet is occupied ● You hear an operation sound at intervals of a few seconds when the cleaning feature is working properly.	-
	When sitting on the toilet seat ● You may hear the sound of water being warmed up. ● When the "Pre-mist" is "ON", sounds can be heard as the toilet unit prepares to spray the pre-mist and while the pre-mist is being sprayed into the bowl unit. → You can turn it "OFF".	16 32
	When moving away from the bowl unit after use ● When "Auto power deodorizer" is "ON", operation sounds are made while the deodorizing power increases for 60 seconds after you stand up from the toilet seat. → You can turn it "OFF". ● You may hear the sound of the remaining water being drained. ● You may hear the fan ventilating the unit. (About 30 minutes)	32 -
	● A mist is sprayed inside the toilet bowl to make it more difficult for dirt to adhere when sitting on the toilet seat. You may feel air when a mist is sprayed. → You can turn it "OFF".	16 32

# Specifications

Item		TCF794CG	
Rated power supply		AC 220-240 V 50 Hz	
Rated power consumption		843-853 W	
Maximum power consumption		1437-1451 W <When the water supply temperature is 0°C>	
Type of water heater		Instantaneous type	
Power cord length		0.9 m	
Water protection level		IPX4	
Cleansing	Spray volume	Rear cleansing	Approx. 0.27-0.43 L/min. <at 0.20 MPa water pressure>
		Rear soft cleansing	Approx. 0.27-0.43 L/min. <at 0.20 MPa water pressure>
		Front cleansing	Approx. 0.29-0.43 L/min. <at 0.20 MPa water pressure>
	Water temperature		Adjustable temperature range: OFF, about 35°C-40°C
	Heater capacity		1200-1428 W
	Safety device		Temperature fuse
	Backflow prevention device		Air gap (according to EN1717), Vacuum breaker
Heated seat	Surface temperature		Adjustable temperature range: OFF, about 28°C-36°C (Auto energy saver: about 26°C, Auto energy saver+: OFF)
	Heater capacity		55-65 W
	Safety device		Temperature fuse
Deodorizer	Method		O <sub>2</sub> deodorization
	Airflow volume		Normal mode: Approx. 0.09 m <sup>3</sup> /min, Power mode: Approx. 0.16 m <sup>3</sup> /min
	Power consumption		Normal mode: Approx. 1.7 W, Power mode: Approx. 5.3 W
Water supply pressure		Minimum required water pressure: 0.1 MPa <dynamic>, Maximum water pressure: 1.0 MPa <static>	
Water supply temperature		0-35°C	
Working ambient temperature		0-40°C	
Dimensions		W 386 mm x D 579 mm x H 146 mm	
Weight		About 7 kg	

# Safety Guidelines

## **A warm-water cleaning toilet seat is an electric appliance.**

Continued use after malfunction occurs or use when its life-time is expired may deteriorate the electric components, producing smoke or resulting in a fire.

### **For safe use of the warm-water cleaning toilet seat**



**If any abnormality of the product is observed, stop using it and consult the installer, seller or the contact listed on the back cover of this manual.**

(A damaged product may cause a fire, electric shock, or may flood the floors with water.)

- Turn off the power immediately and close the shutoff valve.

# Warranty

## MANUFACTURER'S GUARANTEE OF TOTO EUROPE GMBH

### 1. The guarantee of TOTO Europe GmbH

TOTO Europe GmbH (hereinafter referred to as "TOTO") provides a guarantee such that the products it markets shall be free of manufacturing errors in the case of normal use and service for a period of two years from the date of purchase. This guarantee only applies to ultimate consumers.

"Ultimate consumer" within the meaning of this guarantee is any natural person who has entered into a legal transaction for a purpose that can neither be attributable to their commercial nor professional activity and who does not wish to sell the product to other parties.

This guarantee does not affect the ultimate consumer's contractual or statutory rights in dealings with the affected seller and the statutory rights of the ultimate consumer in dealings with the product manufacturer.

Performed repairs that were authorised by TOTO, or any exchange of products or product parts, shall not lead to an extension of the guarantee period and furthermore shall not lead to the guarantee period starting afresh including insofar as these guarantee conditions are included with the substitute product.

### 2. Guarantee

TOTO provides a guarantee such that the TOTO products are free of manufacturing errors. The assessment whether or not a product is faulty is based on the level of technology at the time of manufacture.

TOTO's obligations in accordance with this guarantee are limited, at TOTO's discretion, to the repair or replacement of products or product parts that are considered faulty by TOTO on condition that such products were installed and used in accordance with the instructions for use issued in conjunction with the product and in compliance with all acknowledged demands placed on professional installation. TOTO reserves the right to conduct such investigations that appear necessary to establish the cause of the fault. TOTO shall not charge the ultimate consumer for the cost of the repair, the products or parts of products as part of repairs covered by the guarantee or products that are replaced under the guarantee.

### 3. Preconditions to be met to activate the guarantee

The invoice must be made available to TOTO, for example as a copy, stating the date of purchase, the invoice number, name and address of the ultimate consumer as well as the name and address of the seller for a guarantee claim to be valid. TOTO may request that the ultimate consumer provide photographs that either illustrate the damage and/or the type of connections to the power network or to the fresh and industrial water supply lines. Insofar as TOTO requests this, such photographs must also be presented to render the guarantee valid. A claim based on this guarantee takes for granted that the products for which notification of defects has been provided were installed and used properly and in accordance with the instructions, which TOTO includes in the product delivery, and in this respect the corresponding laws and other legal provisions have been complied with.

If the ultimate consumer claims that the purchased product is faulty, in the event of purchase from an installer, the ultimate consumer is to contact such an installer. In all other cases, the ultimate consumer may contact his/her respective seller or a Service Center authorised by TOTO or contact TOTO itself. Notification of the defect is to be given within a reasonable short period once the defect is identified, at the latest however before the guarantee expires.

# Warranty (Continued)

## 4. Guarantee exclusion

This guarantee does not apply to the following points:

- a) Damage or loss as a result of fire, earthquake, flood, storm or other cases of force majeure, emissions, gas damage (hydrogen sulphide), damage caused by salt or abnormal voltage,
- b) Damage or loss as a result of installation not in accordance with the conditions for use or not in accordance with acknowledged demands placed on professional installation; improper, wrong or inappropriate use or failure to follow the TOTO conditions for use or labels on the product or inappropriate product maintenance contrary to the conditions for use,
- c) Damage or loss as a result of altering, dismantling or destroying the product,
- d) Damage or loss as a result of sedimentation or foreign bodies in the water system,
- e) Damage or loss as a result of the water quality in the region in which the product is used,
- f) Damage or loss as a result of relocation following installation or due to a detrimental environment,
- g) Damage or loss caused by circumstances that do not involve the product itself, for example as a result of intervention in the building structure,
- h) Damage or loss caused by bites from animals or insects such as mice or residues of dead animals or insects,
- i) Damage or loss as a result of freezing the product,
- j) Damage or loss as a result of improper energy supply, which in terms of the voltage, frequency or safety fuses does not comply with the regulatory requirements for power supply in a household or electro-magnetic waves that are caused outside the product such as power lines and peripheral devices,
- k) Damage or loss as a result of attaching the product in moving vehicles such as cars and ships,
- l) Damage or loss as a result of using batteries etc.,
- m) Damage or loss as a result of wear-and-tear of items subject to day-to-day servicing (e.g. deodorizing filter, water drain plug),
- n) If spare parts other than original TOTO spare parts are used during repairs or maintenance of the product,
- o) The fault was caused by the transportation or installation of the product,
- p) The product is a demonstration product/viewing product/former demonstration product/former viewing product,
- q) If consumables (e.g. filters, filter cartridges or batteries) or materials subject to customary wear-and-tear (such as seals or hoses) are affected,
- r) If the fault was caused by the breakage of brittle parts (e.g. sensor windows or small flaps),
- s) If the fault is attributable to the fact that the product damage was caused intentionally or gross negligently by the ultimate consumer or a third party.

In each individual case, TOTO shall assess whether or not the ultimate consumer has a guarantee claim. If TOTO considers the asserted claim to be justified, and examines the affected product for that reason and thereupon it becomes clear that the product was not faulty or a guarantee claim did not apply, TOTO reserves the right to invoice the ultimate consumer for the costs that arise as a result of a visit by TOTO, or a company commissioned by TOTO, to the ultimate consumer and as a result of the rendered or intended services. If the ultimate consumer can furnish proof that the ultimate consumer could not have been aware that the preconditions for a claim were not met, TOTO shall not invoice the ultimate consumer for its visit to the ultimate consumer and the rendered or intended services. In the event that TOTO does not rectify the defect based on the guarantee, TOTO shall invoice the ultimate consumer for the costs that are actually incurred (material, labour and travelling). In the event that the ultimate consumer holds the view that he/she has additional claims as a result of other guarantees, the ultimate consumer is to establish the probable validity of its claim and TOTO shall review such claims.

## 5. Geographical scope of the guarantee

This guarantee is valid exclusively in the European Union and in Switzerland. If a product is installed in a European Union country in which TOTO neither has a marketing company nor a distribution partner, in respect of reviewing the guarantee activating event the ultimate consumer is to propose an installation company that satisfies comparable quality requirements.

## 6. Applicable law

This guarantee is subject to the law of the Federal Republic of Germany with the exception of the requirements on application of international private law and the UN Sales Law.

THIS WRITTEN WARRANTY IS THE ONLY WARRANTY MADE BY TOTO.  
REPAIR OR REPLACEMENT AS PROVIDED UNDER THIS WARRANTY SHALL BE THE EXCLUSIVE REMEDY AVAILABLE TO THE ULTIMATE CONSUMERS.  
TOTO SHALL NOT BE RESPONSIBLE FOR LOSS OF USE OF THE PRODUCT OR FOR OTHER INCIDENTAL, SPECIAL, OR CONSEQUENTIAL DAMAGE OR EXPENSES INCURRED BY PURCHASER, OR FOR LABOR OR OTHER COSTS DUE TO INSTALLATION OR REMOVAL, OR COSTS OF REPAIRS BY OTHERS, OR FOR ANY OTHER EXPENSE NOT SPECIFICALLY STATED ABOVE.

TOTO Europe GmbH  
Zollhof 2  
40221 Düsseldorf  
Germany

# Important User Guidance Information



If you want to dispose this product, do not mix it with general household waste. There is a separate collection system for used electronic products in accordance with legislation that requires proper treatment, recovery and recycling.

Private households in the member states of the EU, Switzerland and Norway may return their used electronic products free of charge to designated collection facilities or to a retailer (if you purchase a similar new one).

For countries not mentioned above, please contact your local authorities for the correct method of disposal.

By doing so you will ensure that your disposed product undergoes the necessary treatment, recovery and recycling, which prevent potential negative effects on the environment and human health.

Only discard discharged batteries. They should not be disposed of with household waste, but rather at appropriate collection sites or at the product retailer.



# TOTO

**Head Office**

TOTO Europe GmbH  
Zollhof 2, 40221 Düsseldorf Germany  
Tel:+49 (0)700 8686 0700

You are advised to record the following information to allow quick service.

Date of purchase :	Name of shop :
Date : year month day	Tel :

2018.2.27  
D07256  
Printed in China.

