

GEBERIT AQUACLEAN SELA

■ GEBERIT

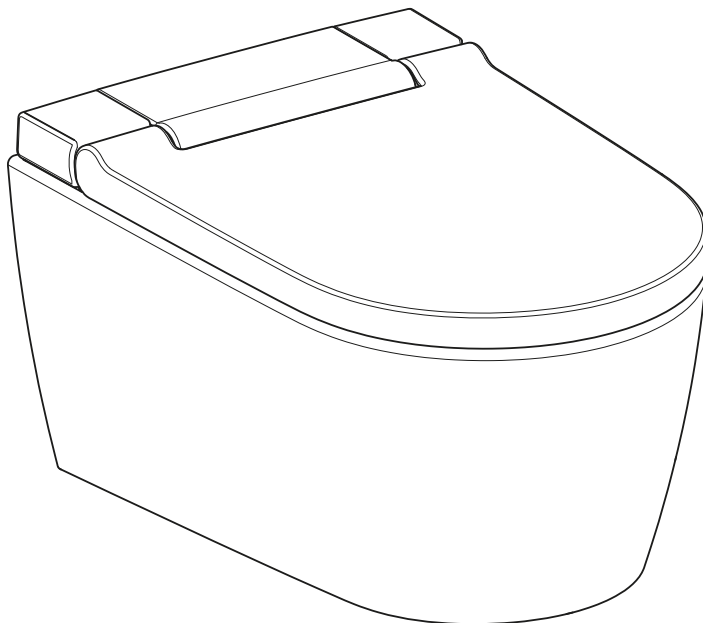

USER MANUAL

Table of contents

For your safety	5
Who is this product suitable for?	5
How is this product used?	5
What should you avoid?	5
Misuse	5
General safety notes	5
Explanation of warning notes	7
Overview of symbols on the product	7
Getting to know your device	8
About Geberit AquaClean devices	8
Functional overview	8
The device at a glance	9
Operating concept	11
About the operating concept	11
Front side of the remote control	11
Rear side of the remote control	12
Geberit AquaClean app	12
How to use the device	13
Getting started	13
Duration of the shower procedure	13
Switching the device on and off	14
Using the anal shower	15
Switching the oscillating motion of the anal shower on and off	15
Using the Lady shower	16
Switching the orientation light off and on	16
Adjusting the shower procedure to your personal needs	17
Setting the spray intensity	17
Setting the spray arm position	17
Quick saving user profiles	18
Saving your personal user profile in the Geberit AquaClean app	18
What happens after I use it?	18
How to program the device	19
Overview of the programming options	19
Changing basic settings	19
Creating a user profile	21
Cleaning and descaling the device	23
Cleaning coated WC ceramic appliances	23
Caring for and cleaning smooth surfaces	23
Automatic water replacement	23
General cleaning recommendations	23
Targeted disinfection	24
Suitable cleaning agents and cleaning equipment	24
Care and maintenance main menu	26
Descaling the device	29
Cleaning the WC seat and housing	31

Cleaning the spray nozzle	32
Cleaning the flushing area of the WC ceramic appliance	32
Troubleshooting	33
Status LED on the orientation light.....	33
Device descaling message.....	33
The shower toilet is not functioning	34
Other functional errors.....	35
The remote control is not functioning	36
Replacing the remote control battery	37
Re-assigning the remote control	37
Sustainability	38
Geberit Group and sustainability	38
Ecodesign – ecobalance	38
Tips for reducing the ecological footprint.....	38
Disposal	39
Disposal of old electrical and electronic equipment	39
End user warranty	40
Register your device	41
Technical data and conformity	42
Technical data.....	42
Simplified EU Declaration of Conformity	42

For your safety

Who is this product suitable for?

As a functioning toilet, the Geberit AquaClean shower toilet is suitable for all age groups. However, children must not carry out cleaning or maintenance work without supervision.

How is this product used?

The product is suitable for the following application purposes and areas of use:

- as a shower toilet:
 - for cleaning the anal area
 - for cleaning the outer vaginal area
- for installation in heated indoor areas
- for connection to the drinking water system
- for operation with water from reverse osmosis systems

What should you avoid?

The product must be used as intended. Do not:

- leave the WC seat ring during the shower procedure
- place loads or objects on the WC lid
- immerse the remote control in liquid
- operate without plug for Geberit AquaClean descaling agent

Misuse

Geberit accepts no liability for the consequences arising from misuse.

General safety notes

The following safety notes apply for the entire duration of the product's life cycle:

- Read the user manual before the first use to familiarise yourself with the use of the product.
- Store the user manual for future reference.

- Do not use the device if it is damaged. If possible, isolate the device from the supply system and contact Geberit customer service.
- Do not open the device. It does not contain any components for the user to service or repair.
- Do not perform any changes or additional installations. Modifying the device runs the risk of fatal danger.
- Repairs may only be carried out by authorised skilled persons using original spare parts.
- Only original accessories may be used.
- Operation and maintenance work may only be performed by the operator or user as described in this user manual.
- Always use the current version of the installation manual for installing the device if the Geberit AquaClean has been removed (e.g. if you move house).
- The Geberit AquaClean must only be connected to a mains voltage conforming to the specification plate.
- Observe the manufacturer information at all times regarding the use of cleaning and descaling agents.



This document contains warning notes at various points. Warning notes are usage and situation-specific safety notes. They provide warnings on specific hazards.



These instructions correspond to the state of the device technology at the time of printing. Geberit reserves the right to make changes in terms of further development.

A current version of this and other documents is available online: www.geberit.com.

Explanation of warning notes

Warning notes are placed at the location at which the hazard may occur.

Warning notes are structured as follows:



WARNING

Nature and source of the hazard

Possible consequences if the hazard is ignored.

- ▶ Measures to prevent the hazard.

The following signal words are used to indicate residual hazards in warning notes and important information.

Symbol	Signal word and meaning
	DANGER The signal word denotes a hazard with a high degree of risk which, if not avoided, will result in death or serious injury.
	ATTENTION The signal word denotes a hazard, which, if not avoided, may result in material damage.
	Symbol only. Refers to important information.

Overview of symbols on the product

Symbol	Meaning
	Read the safety notes and operating instructions/ operation manual before commissioning the product.
	Danger of fatal electric shock

Getting to know your device

About Geberit AquaClean devices

The Geberit AquaClean device is a WC with integrated shower function. The device fulfils all the functions of a conventional toilet. Additional functions are subject to the design of your product.

Functional overview

Hygiene functions:

- TurboFlush flush technology
- WhirlSpray shower technology with individual spray arm position
- spray arm with oscillating motion
- extendible Lady shower nozzle integrated into the spray nozzle with individual spray arm position
- automatic shower arm cleaning before and after each shower procedure
- descaling programme

Comfort functions:

- spray intensity can be selected
- WC seat ring and WC lid with SoftClosing
- remote control with LCD display
- all functions can be operated via remote control
- four individual user profiles can be stored

The device at a glance

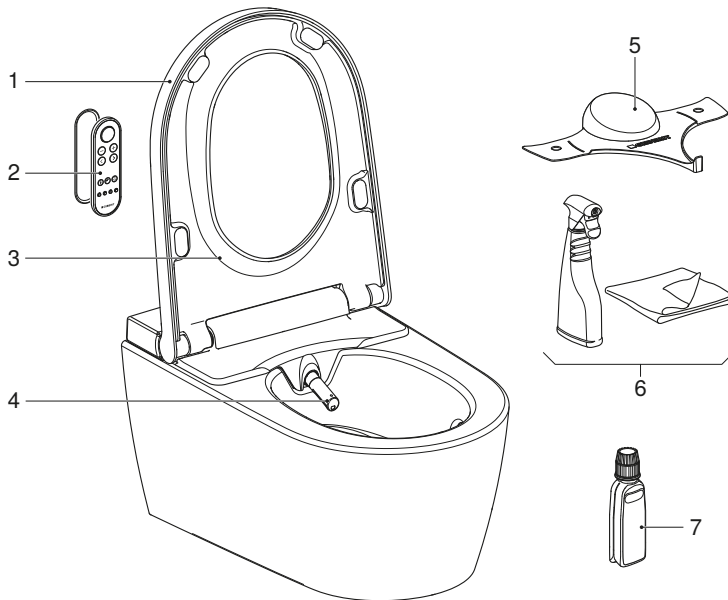

- 1 WC lid
- 2 Remote control with magnetic wall-mounted holder
- 3 WC seat ring
- 4 Spray arm with spray nozzle and Lady shower nozzle
- 5 Spray shield
- 6 Geberit AquaClean cleaning set (art. no. 242.547.00.1)
- 7 Geberit AquaClean descaling agent (art. no. 147.040.00.1)

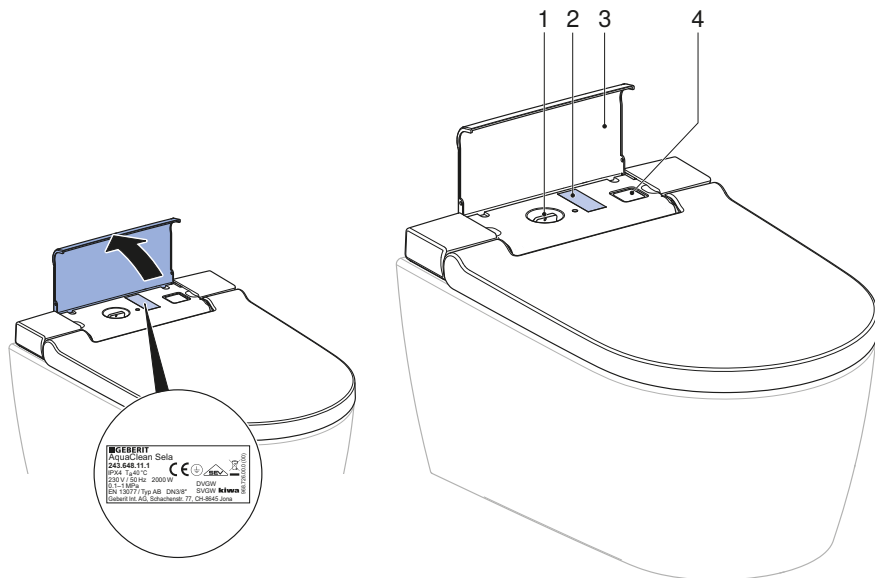

- 1 Filling opening with plug for Geberit AquaClean descaling agent
- 2 Specification plate with serial number
- 3 Design cover
- 4 Power switch

Operating concept

About the operating concept

The shower toilet can be operated via remote control or the Geberit AquaClean app.

Front side of the remote control

All functions for daily use can be operated from the front side of the remote control.

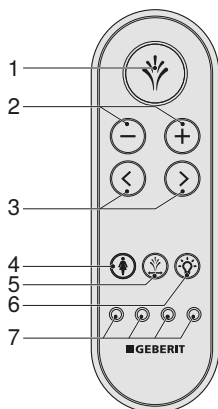

- 1 <Shower> button: start and stop the spray functionality. Stop the Lady shower.
- 2 <->/<+> buttons: decrease or increase the spray intensity.
- 3 <left>/<right> arrow keys: set the spray arm position.
- 4 <Lady shower> button: start and stop the Lady shower.
- 5 <Oscillating motion> button: start and stop the oscillating motion during the anal shower.
- 6 <Orientation light> button: switch the orientation light on and off
- 7 <User profile> buttons: select the user profiles 1–4

Four different user profiles can be stored via the user profile buttons on the remote control.



User profiles allow you to access your personal settings directly. Select your user profile as soon as you sit down.

Rear side of the remote control

You can access system settings and additional functions from the rear side of the remote control.

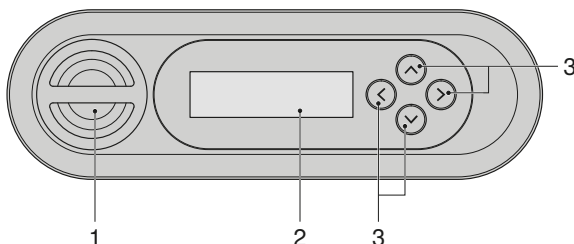

- 1 Battery compartment
- 2 LCD display
- 3 <up>/<down>, <left>/<right> arrow keys

i The remote control has a battery life of several years. The battery can be replaced if the remote control fails.

Geberit AquaClean app

The following shower toilet functions can be executed via the Geberit AquaClean app:

- remotely controlling the Geberit AquaClean shower toilet
- displaying and adjusting the settings

The Geberit AquaClean app offers the following additional benefits:

- saving your personal settings on your smartphone
- support for care and maintenance of the device
- easy registration of your Geberit AquaClean shower toilet
- function films
- service and contact information

The Geberit AquaClean app is available free of charge for Android and iOS smartphones in the respective app stores.

Android:



iOS:



i The range of functions available in the Geberit AquaClean app may vary from country to country.

How to use the device

Getting started



If a user is detected, the basic settings are activated automatically.

→ See Changing basic settings.

However, during the shower procedure, you can make adjustments to suit your personal needs.

The device is fitted with a user recognition unit that detects when the WC seat is under load.

When you sit down on the WC seat, the device enables the spray functionality.

When you leave the WC seat, the spray functionality is deactivated.

Duration of the shower procedure

The anal shower and the Lady shower have different spray times.

- The spray time of the anal shower is 50 seconds. It can be stopped at any time by pressing the <Shower> button again.
- The spray time for the Lady shower is 30 seconds. It can be stopped at any time by pressing the <Lady shower> button again.

Switching the device on and off

i A minimum of 30 seconds must be allowed between the switch-off procedure and the switch-on procedure in order for the electronics to be able to discharge completely.

1 Open the design cover.

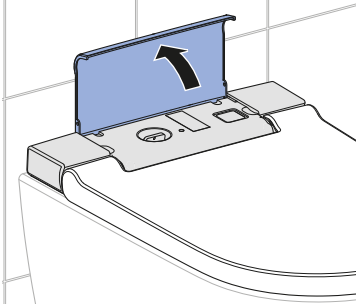

2 Press the power switch.

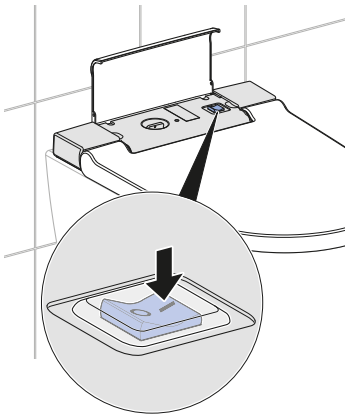

3 Close the design cover.

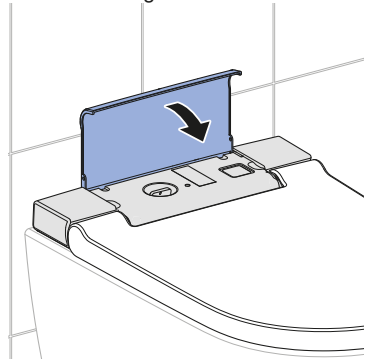

Result

✓ The device initialises again after switching on.

Using the anal shower

Prerequisite

- You are sitting down on the WC seat ring.

- ▶ Briefly press the <Shower> button on the remote control.

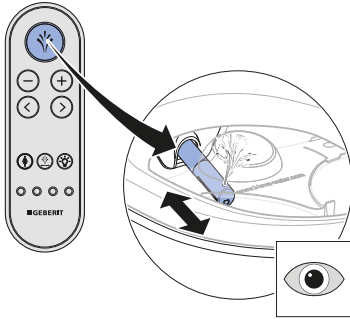

Result

- ✓ The shower procedure starts with the oscillating motion.

- i** You can stop the shower procedure early by pressing the <Shower> button once again.

Switching the oscillating motion of the anal shower on and off

- i** The oscillating motion of the spray arm increases the cleaning effect.

- ▶ The oscillating motion can be switched on and off during the shower procedure by pressing the <Oscillating motion> button or by pressing the <left> and <right> arrow keys at the same time.

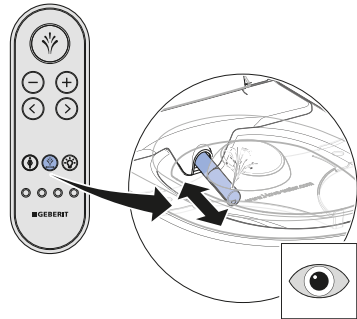

Using the Lady shower

i The woman's intimate area is a very sensitive zone and requires special and prudent care. The Lady shower must be set to your ergonomic conditions to achieve an optimal cleaning result. The position of the spray nozzle and the spray intensity must be selected so that the shower spray cannot penetrate the vagina.

Prerequisite

- You are sitting down on the WC seat ring.

- ▶ Press the <Lady shower> button on the remote control.

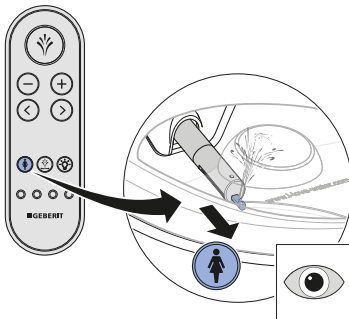

Result

- ✓ The shower procedure starts.

i You can stop the shower procedure early by pressing the <Lady shower> button once again.

Switching the orientation light off and on

Prerequisite

- The device is switched on.

- ▶ Press the <Orientation light> button on the remote control.

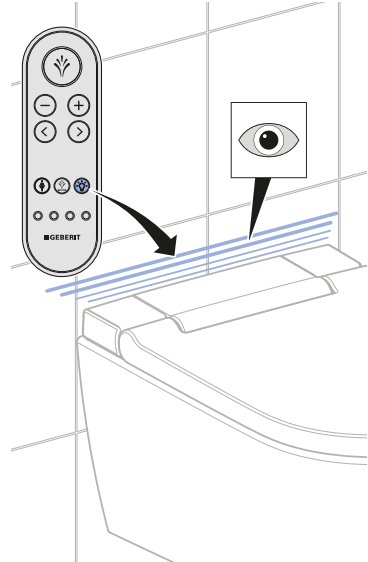

Result

- ✓ The orientation light goes out/lights up.

Adjusting the shower procedure to your personal needs

Setting the spray intensity

Prerequisite

- The shower procedure is running.

- ▶ Press the <+> button to increase the spray intensity. Press the <-> button to decrease the spray intensity.

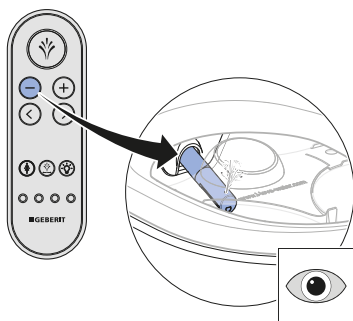
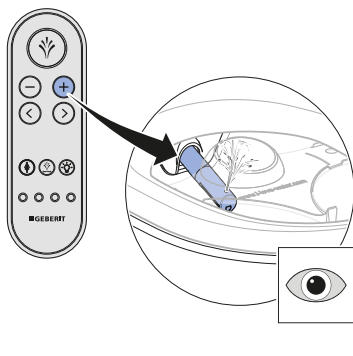

Result

- ✓ The shower spray becomes stronger/weaker.

- i** You can set the spray intensity in 5 stages.

Setting the spray arm position

- i** Female users should set the spray arm position of the spray functionality to their ergonomic conditions so that it does not compromise the natural protection of the vaginal area.

Prerequisite

- The shower procedure is running.

- ▶ Press the arrow keys on the remote control to position the spray arm.

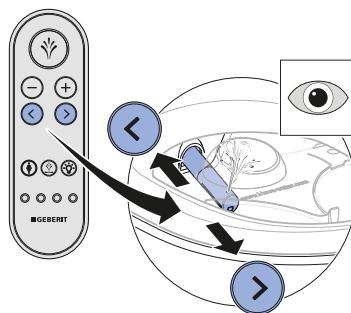

Result

- ✓ The spray arm is optimally positioned.

- i** You can set the spray arm position in 5 stages.

Quick saving user profiles

- ▶ Press one of the 4 user profile buttons for more than 2 seconds to save the current settings.

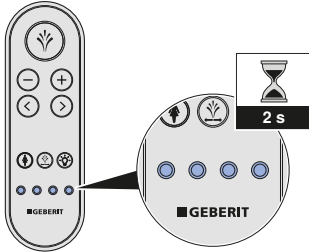

Saving your personal user profile in the Geberit AquaClean app

- i** As long as you are in the detection range of the shower toilet, you do not need to activate the user recognition in order to save your user profile in the Geberit AquaClean app.

Prerequisite

- The current version of the Geberit AquaClean app is installed on your smartphone.
- The Geberit AquaClean app is running.
- You are in the detection range of the shower toilet.

-
- ▶ Save your settings in the Geberit AquaClean app.
-

Result

- ✓ Your personal user profile is saved onto your smartphone.
- ✓ The settings apply to all connected shower toilets.

What happens after I use it?

After use, the device automatically prepares for the next use:

- The spray nozzle is rinsed thoroughly.
- The device is set to economy mode.

How to program the device

Overview of the programming options

The system settings can be configured from the rear side of the remote control. The following main menus are available:

- [Basic settings]
- [Profile settings]
- [Care and maintenance]



- Press any button on the rear side of the remote control to activate the display. The display is automatically deactivated after 30 seconds to save battery life.
- Pressing the <up> arrow key for more than 2 seconds returns the display to the [Basic settings] menu.

Changing basic settings

1

Launch the [Basic settings] main menu using the <left>/<right> arrow keys on the rear side of the remote control.

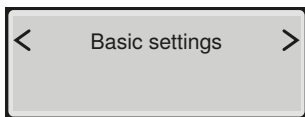
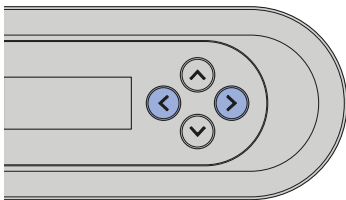

2

Use the <up>/<down> arrow keys to access the next menu item.

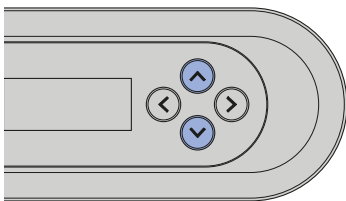

To save the modified settings, the menu must be run through in its entirety until the main menu appears once again on the display.

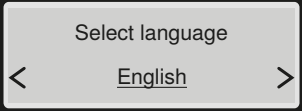
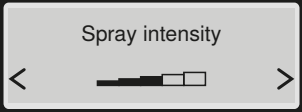
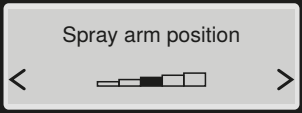
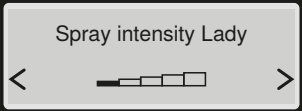
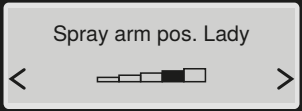
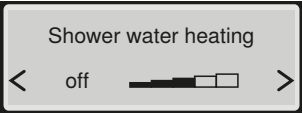
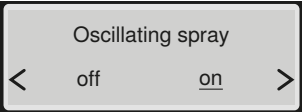
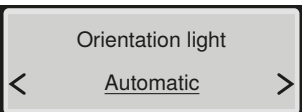
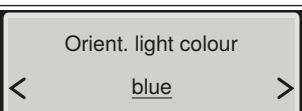
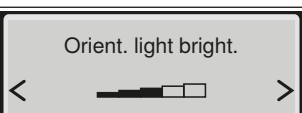
Shown on display	Note
	Select the language of the display
	Spray intensity of the anal shower
	Spray arm position of the anal shower
	Spray intensity of the Lady shower
	Spray arm position of the Lady shower
	Temperature regulation of the shower water
	[on] = The oscillating motion of the spray arm is activated. [off] = The oscillating motion of the spray arm is deactivated.
	[on] = The orientation light stays on permanently. [off] = The orientation light is deactivated. [automatic] = The orientation light switches on when ambient brightness is low, as soon as the brightness falls below the threshold value (light sensor sensitivity).
	Orientation light colours: white/blue/turquoise/magenta/orange/yellow/ warm white
	Adjusting the brightness setting of the orientation light

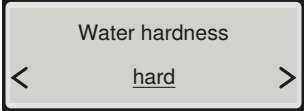
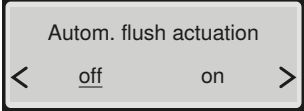
Shown on display	Note
	Adaptable hardness value: hard/medium/soft → See Device descaling message.
	This menu only appears if the optional interface module for the external flush actuation is installed.

Creating a user profile

- 1 Launch the [Profile settings] main menu using the <left>/<right> arrow keys on the rear side of the remote control.

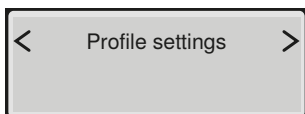
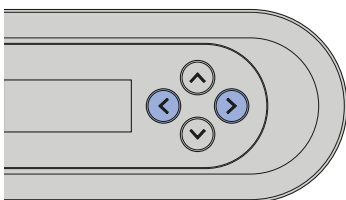

- 2 Use the <up>/<down> arrow keys to select the settings which you would like to change.

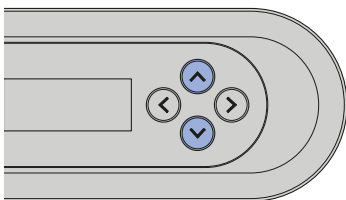

i To save the modified settings, the menu must be run through in its entirety until the main menu appears once again on the display.

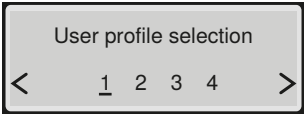
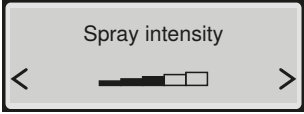
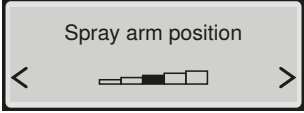
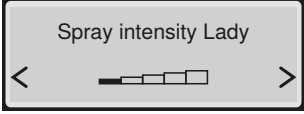
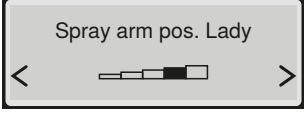
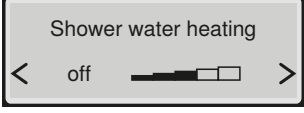
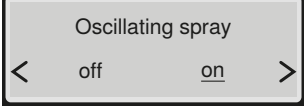
Shown on display	Note
	Corresponds to the user profile buttons on the front side of the remote control
	Spray intensity of the anal shower
	Spray arm position of the anal shower
	Spray intensity of the Lady shower
	Spray arm position of the Lady shower
	Temperature regulation of the shower water
	[on] = The oscillating motion of the spray arm is activated. [off] = The oscillating motion of the spray arm is deactivated.

Cleaning and descaling the device

Cleaning coated WC ceramic appliances

The WC ceramic appliance has a special coating. This coating draws water drops together to form spheres which drip away very effectively. Residue such as limescale and dirt is taken up by the water drops and simply flushed away with them. This effect is very environmentally friendly, as no aggressive WC cleaning agents are required.

Caring for and cleaning smooth surfaces

All smooth surfaces can be cleaned hygienically with water and a mild, liquid cleaning agent that is kind to the skin.



Aggressive and scouring cleaning agents can damage the surface. Only use mild, liquid cleaning agents that are kind to the skin. The Geberit AquaClean cleaning set (art. no. 242.547.00.1) includes a ready-made cleaning agent that is optimal for cleaning all Geberit AquaClean surfaces.

Automatic water replacement

If the shower toilet has not been used for more than 2 months, the device is rinsed with fresh water after it is switched on. This ensures optimum shower water quality before usage.

General cleaning recommendations

Cleaning interval	Cleaning activity
Daily	<ul style="list-style-type: none">▶ Remove water drops with a soft, lint-free cloth to avoid limescale stains.
Weekly	<ul style="list-style-type: none">▶ Clean all surfaces and corners thoroughly. → See "Cleaning the WC seat and housing", page 31.▶ Test spray nozzle and clean if required. → See "Cleaning the spray nozzle", page 32.▶ Rinse the spray nozzle under running water to remove foreign substances.
Monthly	<ul style="list-style-type: none">▶ Clean the WC ceramic appliance with Geberit AquaClean cleaning agent. → See "Cleaning the flushing area of the WC ceramic appliance", page 32.

Targeted disinfection

Disinfection is only recommended if there is a definite risk of infection as a result of germs.

ATTENTION

Surface damage caused by aggressive disinfectants

- ▶ Only use alcohol-based disinfectants that are also suitable for hand and skin disinfection.
- ▶ Observe the safety notes from the manufacturer when handling hazardous substances.

Type of disinfection	Disinfection procedure
Wet wipe disinfection For use on smooth surfaces that can be rubbed	<ul style="list-style-type: none">▶ Moisten all surfaces with disinfectant.▶ Allow the disinfectant to take effect according to the manufacturer information.▶ Then rub the surfaces with single-use towels.
Spray disinfection Only for use on surfaces that are not easily accessible and cannot be rubbed	<ul style="list-style-type: none">▶ Spray the difficult-to-reach surface with disinfectant until wet.▶ Allow the disinfectant to take effect according to the manufacturer information.

Suitable cleaning agents and cleaning equipment

ATTENTION

Damage to the device from aggressive descaling agents





- ▶ Only use Geberit AquaClean descaling agent in the device.



ATTENTION

Surface damage caused by aggressive and scouring cleaning agents

- ▶ Use Geberit AquaClean cleaning agents.

The Geberit AquaClean cleaning set includes a ready-made cleaning agent that is optimal for cleaning all Geberit AquaClean surfaces.

Symbol	Characteristics of suitable cleaning agents
	Skin-friendly
	Cleaning agents are permitted to have a low acid content, e.g. heavily diluted citric acid
	Low-foaming
	Liquid
	Water-dilutable

Symbol	Suitable cleaning equipment
	Soft, fine-pored sponges
	Lint-free, soft cloths which are free of dust
	Toilet brush

Care and maintenance main menu



- Press any button on the rear side of the remote control to activate the display. The display is automatically deactivated after 30 seconds to save battery life.
- Pressing the <up> arrow key for more than 2 seconds returns the display to the [Basic settings] menu.



To save the modified settings, the menu must be run through in its entirety until the main menu appears once again on the display.

1

Launch the [Care and maintenance] main menu using the <left>/<right> arrow keys on the rear side of the remote control.

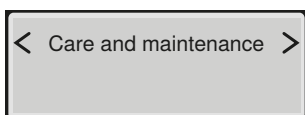
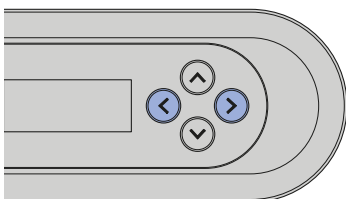

2

Use the up/down arrow keys to access the next menu item.

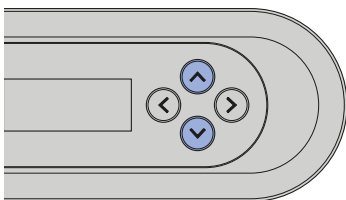

Shown on display	Note
Next descaling in ddd days	Display in days until the next descaling
Descal device now? < no yes >	[yes] = Start descaling. → See "Descaling the device", page 29. [no] = Continue with the [Show device info] menu
Device being prepared ...	
Fill in the descaling agent	Pour the descaling agent into the device. → See "Descaling the device", page 29.
Start descaling? < no yes >	The descaling procedure should not be cancelled after adding the descaling agent because it would otherwise be flushed away unused. The display shows [Device is flushing...].
Descaling time remaining mm minutes	Status message regarding the automatic descaling procedure
Descaling completed	Status message regarding the end of the automatic descaling procedure
Show device info < no yes >	[yes] = Display of the device information [no] = Continue with the [Error message] menu
Model AquaClean Sela	Type/equipment version
Article number 146.22x.xx.1	Geberit article number

Shown on display	Note
<div style="border: 1px solid black; padding: 5px; text-align: center;"> Serial number MBxxxxxxxxxx </div>	Device serial number (required in case of service)
<div style="border: 1px solid black; padding: 5px; text-align: center;"> Commissioning date dd.mm.yyyy </div>	Date the device was first switched on
<div style="border: 1px solid black; padding: 5px; text-align: center;"> Error message xxxxx </div>	An error code is only displayed in the event of an error.
<div style="border: 1px solid black; padding: 5px; text-align: center;"> Demonstration mode < off on > </div>	[on] = Switch on demonstration mode [off] = Back to the [Care and maintenance] main menu
<div style="border: 1px solid black; padding: 5px; text-align: center;"> Activate mode? < no yes > </div>	Safety query for activating demonstration mode

Descaling the device

Information on descaling:

- You will need to descale the device at least once a year, or more often depending on the number of shower cycles.
- During the descaling procedure, you can continue to use the device without the shower toilet functions.
- The descaling procedure lasts up to 40 minutes. During this time, the orientation light flashes orange and you can see the descaling status on the display/smartphone. As soon as the light stops flashing, the spray functionality is ready for operation again.

ATTENTION

Damage to the device from aggressive descaling agents

- ▶ Only use Geberit AquaClean descaling agent in the device.



The descaling procedure should not be cancelled after filling the descaling agent because it would otherwise be flushed away unused. The display shows [Device is flushing...].

Prerequisite

- The spray arm must be fully retracted.
- The WC lid is closed.

- 1 Open the design cover.

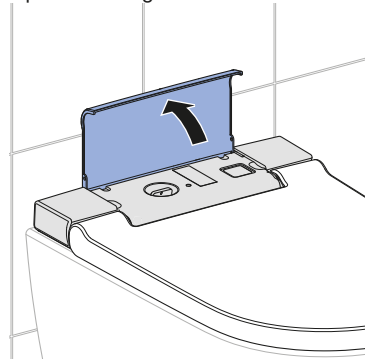

- 2 Remove the plug.

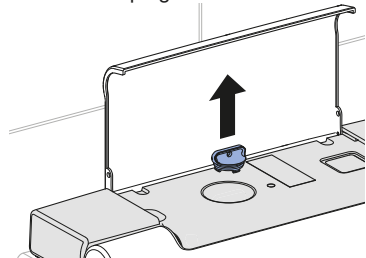

- 3 Launch the [Care and maintenance] main menu using the buttons on the rear side of the remote control.

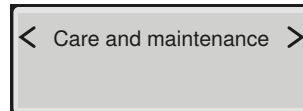

- 4 Use the <down> arrow key to select the [Descal device now?] menu item.

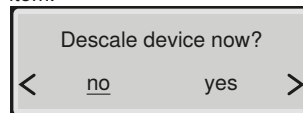

5 Use the arrow keys to select <yes>.

- ✓ The display shows

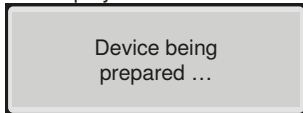

- ✓ Wait until the device is ready. The display shows

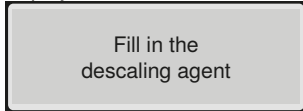

6 Pour a bottle (125 ml) of Geberit AquaClean descaling agent into the filling opening.

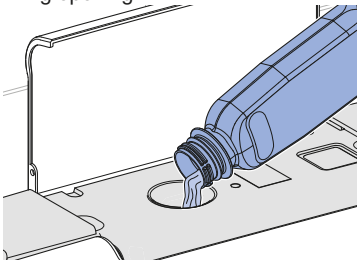

7 Re-insert the plug.

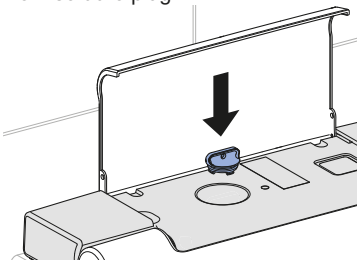

8 Remove splashes of descaling agent immediately with a damp cloth.

9 Close the design cover.

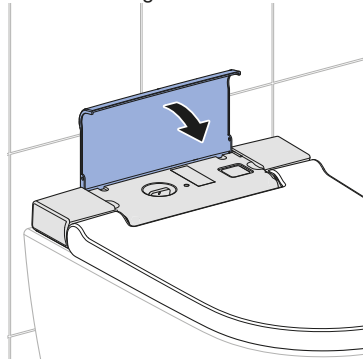

10 Use the arrow key to start the descaling procedure.

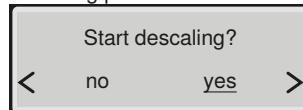

- ✓ A status message appears on the display which shows the duration of the descaling procedure.

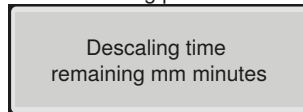

- ✓ The orientation light flashes orange until the descaling procedure is complete.

Cleaning the WC seat and housing

- i** Be careful not to scratch the surface of the WC seat. Always place the components on a soft, non-scratching underlay.
-

- 1** Lift the WC seat.

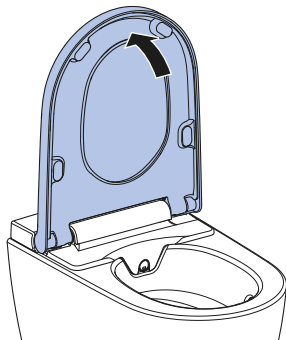

- 2** Lift the WC seat vertically out of its position.

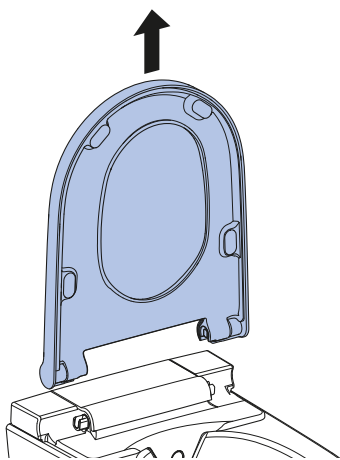

- 3** Spray the surfaces with Geberit AquaClean cleaning agent.

-
- 4** Wipe the surfaces with a soft, lint-free, damp cloth.
-

- 5** Then dry the surfaces with a soft, lint-free cloth.
-

- 6** After cleaning is complete, re-assemble the device in reverse order of disassembly.

Cleaning the spray nozzle



- For cleaning, use a soft, lint-free cloth.
- Geberit AquaClean cleaning agent is particularly suitable for all surfaces of the device.

1 Open the WC lid.

2 Lift the WC seat ring.

3 Press the <Shower> button first.

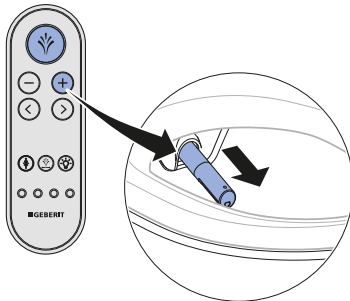

✓ The spray arm extends fully.

4 Pull out the spray nozzle for cleaning and descaling.

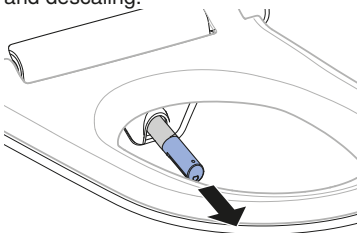

5 Spray the spray nozzle with Geberit AquaClean cleaning agent. Then rinse the spray nozzle with water.

6 Replace the spray nozzle if it can no longer be completely cleaned and descaled.

7 Dry the spray nozzle carefully before re-assembling and re-fitting.

8 Press the <Shower> button.

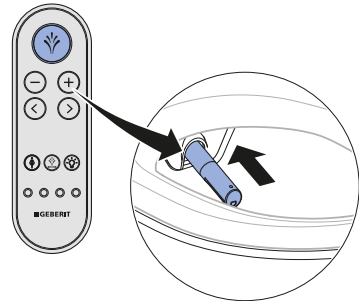

✓ The spray arm retracts fully.

Result

✓ The cleaning procedure is now complete.

Cleaning the flushing area of the WC ceramic appliance

1 Spray the WC ceramic appliance with Geberit AquaClean cleaning agent and allow the cleaning agent a few minutes to take effect.

2 Afterwards, rinse the WC ceramic appliance with water.

3 Remove stubborn stains with a toilet brush.

Troubleshooting

Status LED on the orientation light

The LED on the orientation light informs you of the current device status. The current condition of the device is therefore visible.

LED	Description
Flashes blue	The device initialises after switching on.
Flashes blue/red	The device must be descaled. → See "Descaling the device", page 29
Flashes red	A malfunction message is pending. ▶ If [Error message] is displayed on the remote control/ smartphone: contact customer service.
Flashes orange	<ul style="list-style-type: none"> The device is now descaling. It is not possible to use the shower toilet for the duration of the descaling procedure. Water replacement is being carried out. → See "Automatic water replacement", page 23

Device descaling message

During installation, the device was configured for the local water hardness in accordance with the following table. This adaptation prevents unnecessary descaling procedures and helps protect the environment. Nevertheless, regular descaling of the device is required.

Range	°fH	°dH	°eH
soft	≤ 15	≤ 8	≤ 11
medium	15–25	8–14	11–18
hard	> 25	> 14	> 18



The device can continue to be used normally if the prompt on the display to descale the device is rejected with [no]. Descaling should be carried out soon.

Frequency	Message	Fault clearance
At least once a year	<ul style="list-style-type: none"> The orientation light LED flashes blue/red. The display shows [Descal device now?]. 	<ul style="list-style-type: none"> ▶ Select [yes] on the display and perform a descaling procedure.
Maximum number of shower cycles depending on the water hardness reached		
Double the maximum number of shower cycles depending on the water hardness reached	<ul style="list-style-type: none"> The orientation light LED flashes blue/red. The display shows [Descal device now?]. The device is blocked and urgently needs to be descaled. 	<p>Prerequisite</p> <ul style="list-style-type: none"> – A shower procedure is no longer possible without descaling. ▶ Select [yes] on the display and perform a descaling procedure.

The shower toilet is not functioning

The following table will help you with troubleshooting if the shower toilet is without function.



DANGER

Danger of fatal electric shock

- ▶ Do not open the device.
- ▶ Do not attempt to repair the device yourself.
- ▶ Do not modify the device.
- ▶ Do not replace damaged mains connection cables yourself.



The shower toilet can be used as a normal toilet even in the event of a malfunction. The spray arm must be fully retracted. You start the toilet flush as usual by pressing the buttons on the cistern.



If the device is defective, switch it off using the power switch.

Step	Description of problem	Fault clearance
1	The shower toilet and the status LED are without function.	<ul style="list-style-type: none">▶ Switch the device off and on again. → See Switching the device on and off Result ✓ The device re-initialises.
2	The fuse or residual-current device in the electrical distributor trips once.	<ul style="list-style-type: none">▶ Replace or reset the fuse in the electrical distributor.▶ Reset the residual-current device in the electrical distributor. Result ✓ The device initialises again after switching on. Using the device does not trip any fuses or residual-current devices.
3	The fuse or residual-current device in the electrical distributor trips repeatedly when the device is used.	<ul style="list-style-type: none">▶ Disconnect the mains plug (if available).▶ Replace or reset the fuse or residual-current device in the electrical distributor.▶ Contact customer service. Result ✓ The device is defective.
4	The product has an unknown technical defect.	<ul style="list-style-type: none">▶ Trip the fuse or residual-current device in the electrical distributor.▶ Disconnect the mains plug (if available).▶ Contact customer service.▶ Have the power supply tested by a skilled person.

Other functional errors

The following table will help you with troubleshooting if individual functions of the shower toilet have failed.



The shower toilet can be used as a normal toilet even in the event of a malfunction. The spray arm must be fully retracted. You start the toilet flush as usual by pressing the buttons on the cistern.



If the device is defective, switch it off using the power switch.

Description of problem	Cause	Fault clearance
The status LED flashes red.	Malfunction described in error message has occurred	<ul style="list-style-type: none"> ▶ Note the number of the error message on the display of the remote control and inform customer service.
The spray arm is not functioning correctly.	Malfunction has occurred	<ul style="list-style-type: none"> ▶ Switch off the shower toilet at the power switch for 30 seconds. ▶ Switch on the shower toilet at the power switch. <p>Result</p> <ul style="list-style-type: none"> ✓ The device initialises again after switching on.
The cleaning effect of the shower has weakened.	Spray nozzles clogged or defective	<ul style="list-style-type: none"> ▶ Clean or replace the spray nozzles. ▶ → See "Descaling the device", page 29.
When using the shower function, the shower toilet no longer reaches the usual temperature.	Shower toilet dirty	<ul style="list-style-type: none"> ▶ → See "Descaling the device", page 29. ▶ Switch off the shower toilet at the power switch for 30 seconds. <p>Result</p> <ul style="list-style-type: none"> ✓ The device initialises again after switching on.

The remote control is not functioning

The following table will help you with troubleshooting if:

- the remote control is without function.
- the remote control is unable to control the shower toilet.



The remote control is inactive while the Geberit AquaClean app is in use.



If the device is defective, switch it off using the power switch.

Step	Description of problem	Fault clearance
1	The remote control display shows [no connection] when buttons are pressed.	<ul style="list-style-type: none">▶ Re-assign the remote control. → See Re-assigning the remote control. Result ✓ The display shows [Pairing ok].
2	The remote control is unable to control the shower toilet. The remote control has been re-assigned.	<ul style="list-style-type: none">▶ Replace battery (type CR2032). → "Replacing the remote control battery", page 37.▶ Re-assign the remote control. → See Re-assigning the remote control.
3	The battery has been replaced and the remote control has been re-assigned. The remote control display still remains unresponsive when buttons are pushed.	<ul style="list-style-type: none">▶ Contact customer service. Result ✓ Remote control is defective.

Replacing the remote control battery

Prerequisite

- During the entire procedure, the remote control must be located in the reception range of the shower toilet.

- 1 Remove the used battery. Dispose of the used battery appropriately.

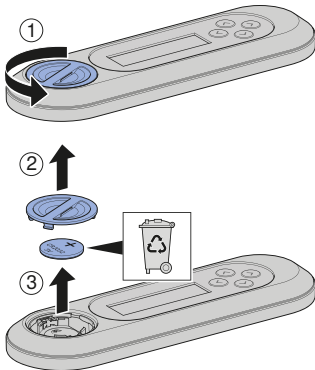

- 2 Insert a new CR2032 battery.

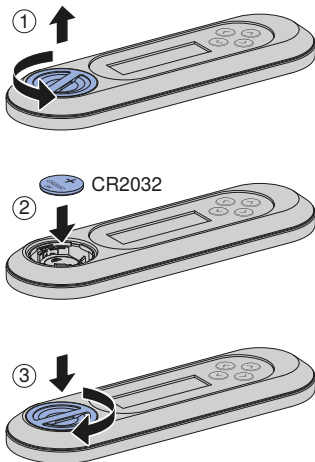

Re-assigning the remote control

-  The device can only be operated with a single, assigned remote control.

Prerequisite

- The device is switched off.

- ▶ Switch the device on and press the <+> button on the remote control for approx. 30 seconds until [Pairing ok] appears on the display.

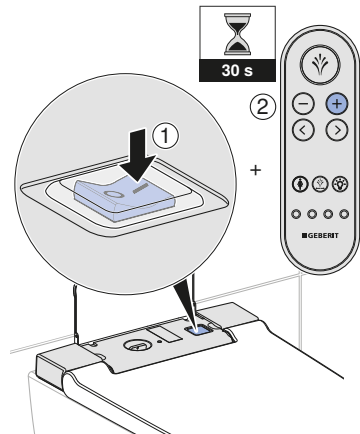

Result

- ✓ The shower toilet can be controlled by remote control.

Sustainability

Geberit Group and sustainability

As the European market leader in the sanitary industry, Geberit stands for water saving, resource efficiency and sustainable building. The Group has proven for decades that long-term business success is compatible with environmentally friendly actions and social policies. A company management geared to sustainability helps to save costs while minimizing risks at the same time. Geberit aims to act as a role model and set standards for its customers, suppliers and other partners. This means creating water-saving and sustainable products, using safe, environmentally friendly and resource-efficient production practices, engaging in purchasing and logistics activities with high environmental and ethical standards, and offering excellent working conditions for more than 12 000 dedicated and highly qualified employees worldwide. One way in which the company is showing its awareness of social responsibility is by participating in water relief projects around the world.

Ecodesign – ecobalance

The basis for sustainable products is formed by a systematic innovation process in which product materials and functional principles are chosen that are as environmentally friendly as possible, risks are minimised and a high degree of resource efficiency is strived for. We can supply a detailed ecobalance for this product upon request.

Tips for reducing the ecological footprint

This product was developed with the utmost care, also with regard to the consumption of energy, water and resources (see also technical data). You can reduce the ecological footprint of the product by observing the following recommendations:

- Switch off the device when you go on holiday.
- Interrupt the spray functionality manually in order to save hot water.
- Use small amounts of paper for drying.
- Switch off the heating function of the water heater when you do not need warm shower water.
- Use environmentally friendly cleaning agents.
- Carry out regular maintenance on the device and handle it with care in order to extend the service life.
- Return defective devices to Geberit or a designated partner for appropriate disposal.

Disposal

Disposal of old electrical and electronic equipment



■

In accordance with Directive 2012/19/EU (WEEE - Waste Electrical and Electronic Equipment) manufacturers of electrical equipment are obliged to take back old equipment and to dispose of it appropriately. The symbol indicates that the product cannot be disposed of with non-recyclable waste. Old equipment should be returned directly to Geberit where it will be disposed of appropriately. Addresses to which equipment can be returned can be requested from the relevant Geberit sales company.

End user warranty

End user warranty

The following end user warranty is provided in addition to and does not affect your contractual partner's liability for defective products.

The Geberit company ("Geberit") responsible for the place of installation of the Geberit AquaClean product ("product") shall provide the end user with a warranty for the product identified by the serial number on the warranty card. The scope of this warranty is as follows:

1. Geberit guarantees that the product shall be free from material defects and manufacturing faults for a period of 3 years ("warranty period") calculated from the installation date at the end user's premises. Warranty scope:
 - a) Within the first 2 years of the warranty period, a customer service representative authorised by Geberit shall rectify any material defects or manufacturing faults free of charge by repairing or replacing the defective parts.
 - b) In the third year of the warranty period, Geberit shall supply replacements for defective parts free of charge to the customer service representative authorised by Geberit and contracted by the end user to repair the product.
2. The end user shall not be entitled to assert more extensive claims against Geberit on the basis of this warranty.
3. Claims can only be made under the warranty if:
 - a) The product has been installed and put into operation by an installation company or by customer service personnel authorised by Geberit.
 - b) No modifications have been made to the product; in particular, no parts have been removed, replaced or added.
 - c) The product defect has not been caused by improper installation or use, nor can it be attributed to inadequate care or maintenance.
 - d) Claims shall only be made during the third year of the warranty period if the end user has completed the enclosed warranty card in full and returned it to the Geberit company responsible for the place of installation within 90 working days of the installation date.
4. This warranty applies solely to places of installation in countries in which Geberit has its own sales company or is represented by a sales partner.
5. The warranty is exclusively subject to the substantive law of the country in which Geberit has its place of business. The United Nations Convention on Contracts for the International Sale of Goods is expressly excluded. The exclusive place of jurisdiction for all disputes arising from or in connection with this warranty is the location of Geberit's headquarters.

Register your device

Warranty registration

Extend the warranty period of your Geberit AquaClean for free. Register for this within 90 working days from the installation date.



In the third year of the warranty period, Geberit shall supply spare parts free of charge in the event of any material or manufacturing faults, provided the product has been installed and put into operation by an installation company.

By computer:

<http://www.geberit-aquaclean.com/registration>

By post:

Fill out the warranty card supplied and send it to us.

By smartphone or tablet:



Android:



iOS:



Via the Geberit AquaClean app:

Technical data and conformity

Technical data

Nominal voltage	230 V AC
Mains frequency	50 Hz
Frequency range	2400-2483.5 MHz
Maximum output power	0 dBm
Power consumption	1850 W
Power consumption standby	≤ 0.5 W
Protection degree	IPX4
Protection class	I
Wireless technology	Bluetooth® Low Energy ¹⁾
Mains connection	Mains connection via system plug with flexible three-wire sheathed cable
Spray time	30-50 s
Number of shower pressure settings, shower spray	5
Water temperature	34-40 °C
Operating temperature	5-40 °C
Flow pressure	50–1000 kPa
	0.5–10 bar
Minimum flow pressure	50 kPa
	0.5 bar
Calculated flow rate	0.03 l/s
Maximum load, WC seat	150 kg

¹⁾ The Bluetooth® brand and its logos are the property of Bluetooth SIG, Inc. and are used under license by Geberit.

Simplified EU Declaration of Conformity

Hereby, Geberit International AG, declares that the radio equipment type AquaClean Sela is in compliance with Directive 2014/53/EU.

The full text of the EU declaration of conformity is available at the following internet address: <https://doc.geberit.com/968859000.pdf>.

(CH) Geberit Vertriebs AG
Schachenstrasse 77
CH-8645 Jona
T 0848 882 982
www.geberit-aquaclean.ch

(DE) Geberit Vertriebs GmbH
Kundendienst/Servicestelle
Theuerbachstrasse 1
D-88630 Pfullendorf
T (075 52) 934 10 11
F (075 52) 934 866
www.geberit-aquaclean.de

(AT) Geberit Vertriebs GmbH & Co. KG
Geberitstrasse 1
A-3140 Pottenbrunn / St. Pölten
T +43 2742 401-400
F +43 2742 401-50
www.geberit-aquaclean.at

(AE) Geberit International Sales AG
Dubai Branch
B702-B705
Building No. 1
Dubai Design District
PO Box
UAE-282317 Dubai
T +971 4 204 5477
F +971 4 204 5497
www.geberit.ae

(BE) Geberit nv
Beaulieustraat 6
B-1830 Machelen
T +32 2 252 0111
F +32 2 251 0867
www.geberit-aquaclean.be

(BG) Юнитрейд Интернешънъл ЕООД
бул. "Черни връх" 161-А
1407 София
T 02/ 968 11 11
F 02/ 968 10 01
www.unitrade-bg.com

(CN) 吉博力(上海)贸易有限公司
地址: 上海市嘉定区南翔高科技
园区惠平路1515号
邮编: 201802

(CZ) Geberit spol. s r.o.
Sokolovská 2408/222
190 00 Praha 9
T +420 547 212 335
F +420 547 212 340
www.geberit.cz

(DK) Geberit A/S
Lægårdsvej 26
DK-8520 Lystrup
T +45 86 74 10 86
F +45 86 74 10 98
www.geberit-aquaclean.dk

(ES) Geberit, S.A.U.
Plaza Europa, 2-4, 6ª planta
ES-08902 L'Hospitalet del Llobregat
(Barcelona)
T +34 902 170 635
www.geberit-aquaclean.es

(FI) Geberit Oy
Tahkotie 1
FI-01530 Vantaa
P +358 9 867 8450
www.geberit.fi

(FR) Geberit France
ZA du Bois Gasseau - CS40252
Samoreau
FR-77215 Avon Cedex
Téléphone 01 60 71 66 61
T +33(0)825 801 603
F +33(0)825 801 604
www.geberit-aquaclean.fr

(GB) Geberit Sales Ltd.
Geberit House
Edgehill Drive
Warwick
CV34 6NH
T (0)1926 516 800
T (0)1926 516 809
In Eire T +44 1622 717 811
www.geberit-aquaclean.co.uk

(HR) Predstavništvo Geberit
prodaja d.o.o. Ruše
Samoborska cesta 218
10090 Zagreb, HR
T +385 1 3867 800
F +385 1 3867 801
www.geberit.hr

(HU) Geberit Kft
1117 Budapest,
Alíz utca 2.
T +36 1 204 4187
www.geberit.hu

(IT) Geberit Marketing e Distribuzione SA
Via Gerre 4
CH-6928 Manno
T +41 91 611 92 92
F +41 91 611 93 93
www.geberit-aquaclean.it

(LU) Geberit Luxembourg
61, avenue de la Libération
L-3850 Schifflange
T +352 54 52 26
F +352 54 54 91
www.geberit.lu

(NL) Geberit B.V.
Fultonbaan 15
3439 NE Nieuwegein
T +31 (0)3060 57700
F +31 (0)3060 53392
www.geberit-aquaclean.nl

(NO) Geberit AS
Luhrtoppen 2
N-1470 Lørenskog
T +47 67 97 82 00
www.geberit-aquaclean.no

(PL) Geberit Sp. z o.o.
ul. Postępu 1
02-676 Warszawa
T +48 22 843 06 96
www.geberit-aquaclean.pl

(PT) Geberit Tecnologia Sanitária, S.A
Rua Cupertino de Miranda, nº 12-2º A
PT-1600-485 LISBOA
www.geberit.pt

(RO) Geberit International Sales AG
Splaiul Unirii, Nr. 86, Et. 3
Sector 4, Bucharest
T +40 21 330 30 80/81
F +40 21 330 31 61
www.geberit.ro

(RS) Geberit - Predstavništvo za
Republiku Srbiju i Republiku Crnu Goru
Vojvode Skopljanca 24
SR-11000 Beograd
T + 381 11 30 96 430
F + 381 11 30 96 431
www.geberit.rs

(RU) ООО „ГЕБЕРИТ РУС“
Олимпийский пр., 16, стр.5, 5 этаж
129110 Москва
тел.: +7 495 783 83 30
www.geberit.ru

(SE) Geberit AB
Folketshusgatan 1
Box 140
295 22 Bromölla
T +46 40 680 89 30
www.geberit.se

(SI) Geberit prodaja, d.o.o.
Bezena 55
2342 Ruše
T 01 586 22 00
F 01 586 22 19
www.geberit.si

(SK) Geberit Slovensko s.r.o
Karadžičova 10
821 08 Bratislava 2
T +421 2 49 20 30 71
www.geberit.sk

(TR) Geberit Tesisat Sistemleri Tic Ltd. ti.
İçerenköy Mah. Engin Sok. No. 10,
34752 Ataşehir-Ystanbul, Turkey
T +90 216 340 82 73
F +90 216 340 82 79
www.geberit.com.tr

(ZA) Geberit Southern Africa (Pty.) Ltd.
6 Meadowview Lane,
Meadowview Business Estate,
Longmeadow,
Linbro Park
Johannesburg,
South Africa
T +27 11 444 5070
F +27 11 444 5992
www.geberit.co.za