

**GEBERIT AQUACLEAN
TUMA CLASSIC**

■ GEBERIT

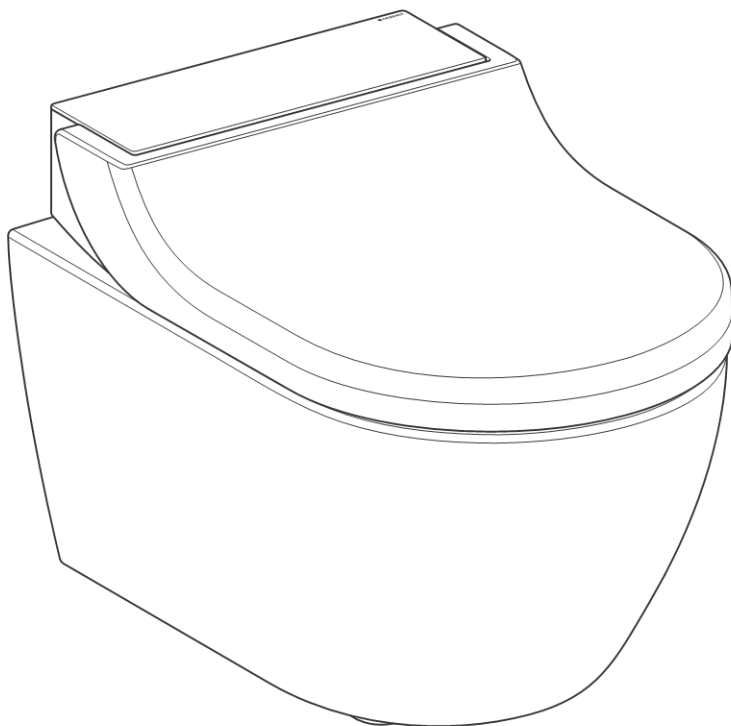

USER MANUAL

Table of contents

For your safety	5
Who is this product suitable for?	5
How is this product used?	5
What should you avoid?	5
Misuse	5
General safety notes.....	6
Overview of the alert levels and symbols in these instructions.....	8
Overview of symbols on the product.....	8
Register your device.....	9
Getting to know your device	10
About Geberit AquaClean devices.....	10
Functional overview	10
Duration of the shower procedure	10
The device at a glance.....	11
Switching the device on and off	13
Operating concept	15
Lateral control panel	15
Special assignment of the buttons.....	16
Geberit AquaClean app	16
How to use the device	17
Your device settings	17
Additional settings of your device in the Geberit AquaClean app.....	17
Using the anal shower	18
Setting the spray intensity.....	18
Saving your personal user profile in the Geberit AquaClean app.....	19
What happens after use?.....	19
Cleaning and descaling the device.....	20
Cleaning coated WC ceramic appliances	20
Caring for and cleaning smooth surfaces	20
Automatic water replacement	20
General cleaning recommendations	20
Targeted disinfection	21
Suitable cleaning agents and cleaning equipment	21
Device descaling message	23
Removing the WC lid	23
Descaling the device.....	24
Cleaning the WC lid, WC seat ring and housing.....	26
Cleaning between the device and the WC ceramic appliance.....	27
Cleaning the spray nozzle	28
Cleaning the flushing area of the WC ceramic appliance	29
Troubleshooting.....	30
The shower toilet is not functioning	30
Other functional errors	31

Sustainability	32
Geberit Group and sustainability	32
Ecodesign – ecobalance.....	32
Tips for reducing the ecological footprint	32
Constituents.....	33
Disposal of old electrical and electronic equipment.....	33
End user warranty	34
Technical data and conformity	35
Technical data	35
Declaration of conformity	35

For your safety

Who is this product suitable for?

As a functioning toilet, the Geberit AquaClean shower toilet is suitable for all age groups. However, children must not carry out cleaning or maintenance work without supervision.

How is this product used?

The product is suitable for the following application purposes and areas of use:

- as a shower toilet:
 - for cleaning the anal area
- for installation in heated indoor areas
- for connection to the drinking water system
- for operation with water from reverse osmosis systems

What should you avoid?

The product must be used as intended. Do not:

- leave the WC seat during the shower procedure
- place loads or objects on the WC lid
- operate without plug for Geberit AquaClean descaling agent

Misuse

Geberit accepts no liability for the consequences arising from misuse.

General safety notes

The following safety notes apply for the entire duration of the product's life cycle:

- Read the user manual before the first use to familiarise yourself with the use of the product.
- Store the user manual for future reference.
- Do not use the device if it is damaged. If possible, isolate the device from the supply system and contact Geberit customer service.
- Do not open the device. It does not contain any components for the user to service or repair.
- Do not perform any changes or additional installations. Modifying the device runs the risk of fatal danger.
- Repairs may only be carried out by authorised skilled persons using original spare parts.
- Only original accessories may be used.
- Operation and maintenance work may only be performed by the operator or user as described in this user manual.
- Always use the current version of the installation manual for installing the device if the Geberit AquaClean has been removed (e.g. if you move house).
- The Geberit AquaClean must only be connected to a mains voltage conforming to the specification plate.
- Observe the manufacturer information at all times regarding the use of cleaning and descaling agents.

i This document contains warning notes at various points. Warning notes are usage and situation-specific safety notes. They provide warnings on specific hazards.

i These instructions correspond to the state of the device technology at the time of printing. Geberit reserves the right to make changes in terms of further development.

A current version of this and other documents is available online. www.geberit.com

Overview of the alert levels and symbols in these instructions

Alert levels and symbols



DANGER

Indicates an imminently threatening hazard which, if not avoided, will lead to death or serious injury.



WARNING

Indicates a potentially threatening hazard which, if not avoided, could lead to death or serious injury.



ATTENTION

Indicates a hazard which, if not avoided, can lead to material damage.



Refers to important information.

Overview of symbols on the product

Symbol	Meaning
	Read the safety notes and operating instructions/ operation manual before commissioning the product.
	Danger of fatal electric shock

Register your device

Warranty registration

Extend the warranty period of your Geberit AquaClean for free. Register for this within 90 working days from the installation date.



In the third year of the warranty period, Geberit shall supply spare parts free of charge in the event of any material or manufacturing faults, provided the product has been installed and put into operation by an installation company.

By computer: <http://www.geberit-aquaclean.com/registration>

By post: Fill out the warranty card supplied and send it to us.

By smartphone or tablet:



Android:



iOS:



Via the Geberit AquaClean app:

Getting to know your device

About Geberit AquaClean devices

The Geberit AquaClean device is a WC with integrated shower function. The device fulfils all the functions of a conventional toilet. Additional functions are subject to the design of your product.

Functional overview

Hygiene functions:

- WhirlSpray shower technology
- automatic spray nozzle cleaning before and after each shower procedure

Comfort functions:

- spray intensity can be selected
- WC seat ring and WC lid with SoftClosing
- ergonomic lateral control panel

Cleaning and care:

- removable WC lid
- WC enhancement solution can be raised to clean between device and WC ceramic appliance
- descaling programme

Duration of the shower procedure

The spray time of the anal shower is 50 seconds. It can be stopped at any time by pressing the <Shower> button again.

The device at a glance

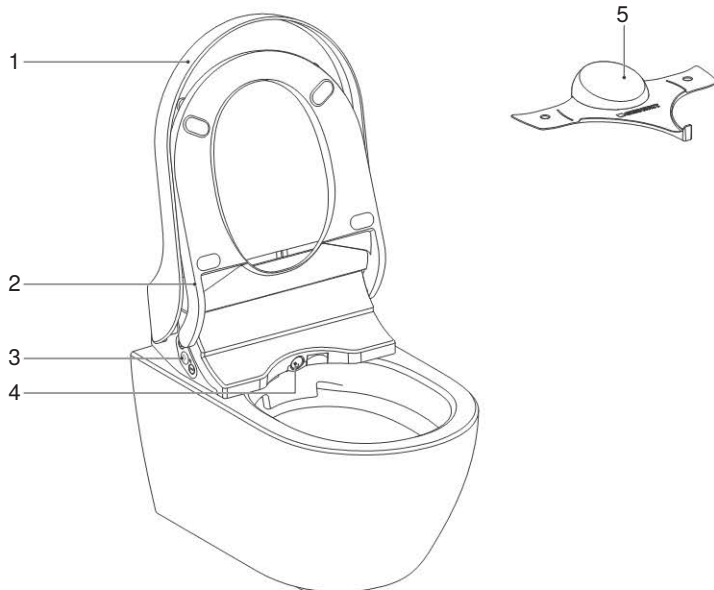

- 1 WC lid
- 2 WC seat ring
- 3 Lateral control panel with status LED
- 4 Spray arm with spray nozzle
- 5 Spray shield

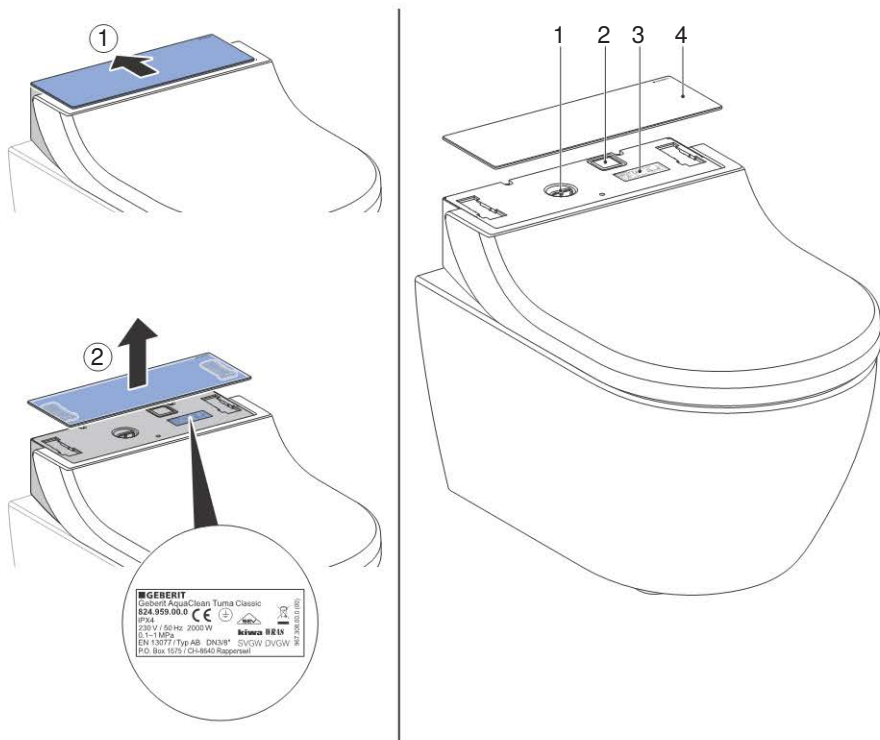

- 1 Filling opening with plug for descaling agent¹⁾
- 2 Power switch
- 3 Specification plate with serial number
- 4 Design cover

¹⁾ Geberit AquaClean descaling agent (art. no. 147.040.00.1)

Switching the device on and off



A minimum of 30 seconds must be allowed between the switch-on procedure and the switch-off procedure in order for the electronics to be able to discharge completely.

- 1 Lift the WC lid.

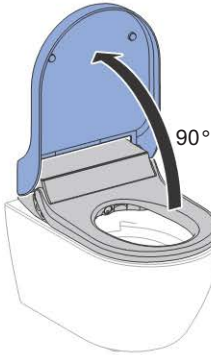

- 2 Remove the WC lid.

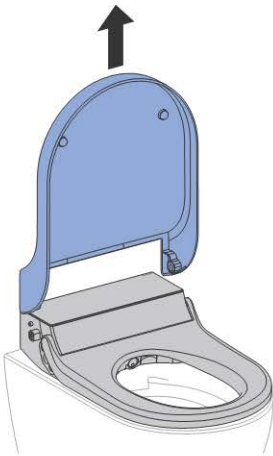

- 3 Remove the design cover.

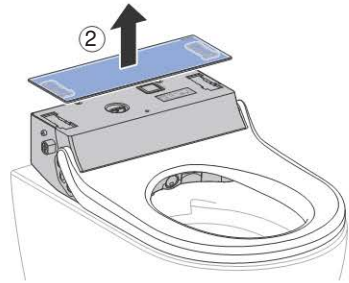
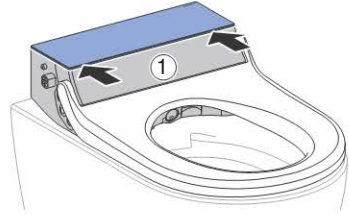

- 4 Press the power switch.

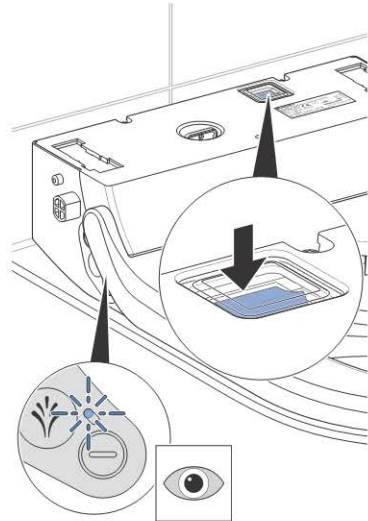

- ✓ The LED on the lateral control panel flashes/goes out.

-
- 5** Mount the design cover.

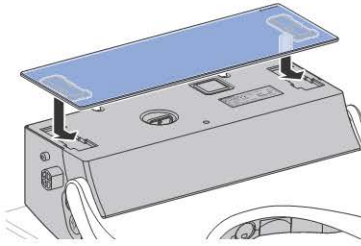

- 6** Mount the WC lid.

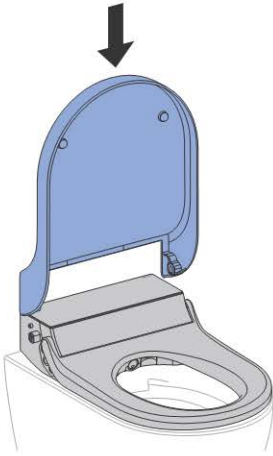

-
- 7** Close the WC lid.



Result

- ✓ The device initialises again after switching on.

Operating concept

Lateral control panel

The shower toilet functions of the device can be operated from the lateral control panel.

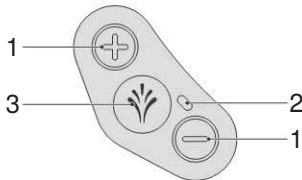

- 1 <+>/<-> buttons: increase or decrease the spray intensity
- 2 Status LED
- 3 <Shower> button: start and stop odour extraction

Table 1: Status LED on the lateral control panel

LED	Description
Flashes blue	The device initialises after switching on. A system flush is performed.
Lights up blue	The continuous flow heater is switched on.
Does not light up	The continuous flow heater is switched off.
Lights up red	The device must be descaled. → See "Descaling the device", page 24
Flashes red	Malfunction message → See "The shower toilet is not functioning", page 30
Flashes red and lights up orange	The device is blocked and urgently needs to be descaled. The spray functionalities cannot be used when blocked. The block can be reset for 50 shower cycles. To implement this, the <Shower> button must be pressed for 5 seconds.
Lights up orange	The device is now descaling. It is not possible to use the shower toilet for the duration of the descaling procedure.
Flashes orange	Water replacement is being carried out. → See "Automatic water replacement", page 20
Flashes red/orange	The device is in descaling mode and is waiting for user action



The buttons of the control panel are designed ergonomically. Each button has an individual, tangible surface form.

Special assignment of the buttons

You can access advanced functions of your shower toilet using specially assigned buttons.

Table 2: Lateral control panel

Function	Button on the lateral control panel	On	Off
Extend spray arm for cleaning	Briefly press <+> and <Shower> at the same time.	–	–
Start the descaling function	Press <-> and <Shower> at the same time for 5 seconds.	–	–
Hide the descaling message for a further 50 shower cycles	Press the <Shower> button for 5 seconds.	Beep (1x)	–
Switch demonstration mode on/off	Press <+> and <-> at the same time for 5 seconds.	Beep (1x)	Beep (2x)

Geberit AquaClean app

The following shower toilet functions can be executed via the Geberit AquaClean app:

- remotely controlling the Geberit AquaClean shower toilet
- displaying and adjusting the settings

The Geberit AquaClean app offers the following additional benefits:

- saving your personal settings on your smartphone
- support for care and maintenance of the device
- easy registration of your Geberit AquaClean shower toilet
- function films
- service and contact information

The Geberit AquaClean app is available free of charge for Android and iOS smartphones in the respective App Store.

Android:



iOS:



How to use the device

Your device settings

Setting	Adjustment range	Factory setting of basic profile
Spray intensity of the anal shower	level 1–5	level 3

Additional settings of your device in the Geberit AquaClean app

Setting	Adjustment range	Factory setting of the basic profile
Spray arm position of the anal shower	level 1–5	level 3
Oscillating function of the spray arm on the anal shower	on/off	on
Hot water of the spray functionality	on/off	on
Shower water temperature	level 1–5	level 4
Water hardness → See "Device descaling message", page 23	soft/medium/hard	hard

Using the anal shower

Prerequisite

- You are sitting down on the WC seat ring.

- ▶ Briefly press the <Shower> button on the lateral control panel.

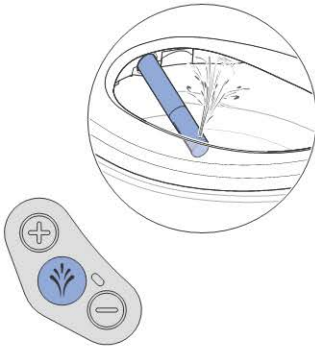

Result

- ✓ The shower procedure starts.
- ✓ A small amount of water drains into the WC ceramic appliance via the overflow.

- i** You can stop the shower procedure early by pressing the <Shower> button once again.

Setting the spray intensity

Prerequisite

- The shower procedure is running.

- ▶ Press the <+> button to increase the spray intensity. Press the <-> button to decrease the spray intensity.



Result

- ✓ The shower spray becomes stronger/weaker.

- i** You can set the spray intensity in 5 stages.

Saving your personal user profile in the Geberit AquaClean app

Prerequisite

- The current version of the Geberit AquaClean app is installed on your smartphone.
- The Geberit AquaClean app is running.
- You are in the detection range of the shower toilet.

-
- ▶ Save your settings in the Geberit AquaClean app.
-

Result

- ✓ Your personal user profile is saved onto your smartphone.
- ✓ The settings apply to all connected shower toilets.

What happens after use?

After use, the device automatically prepares for the next use:

- The spray nozzle is rinsed thoroughly.
- The shower toilet automatically switches to economy mode as soon as no device functions are active.

Cleaning and descaling the device

Cleaning coated WC ceramic appliances

The WC ceramic appliance has a special coating. This coating draws water drops together to form spheres which drip away very effectively. Residue such as limescale and dirt is taken up by the water drops and simply flushed away with them. This effect is very environmentally friendly, as no aggressive WC cleaning agents are required.

Caring for and cleaning smooth surfaces

All smooth surfaces can be cleaned hygienically with water and a mild, liquid cleaning agent that is kind to the skin.



Aggressive and scouring cleaning agents can damage the surface. Only use mild, liquid cleaning agents that are kind to the skin. The Geberit AquaClean cleaning set (art. no. 242.547.00.1) includes a ready-made cleaning agent that is optimal for cleaning all Geberit AquaClean surfaces.

Automatic water replacement

If the shower toilet has been restarted or has not been used for more than 2 weeks, the device is rinsed with fresh water after it is switched on. This ensures optimum shower water quality before usage.

General cleaning recommendations

Cleaning interval	Cleaning activity
Daily	<ul style="list-style-type: none">Remove water drops with a soft, lint-free cloth to avoid limescale stains.
Weekly	<ul style="list-style-type: none">Clean all surfaces and corners thoroughly. → See "Cleaning the WC lid, WC seat ring and housing", page 26Test spray nozzle and clean if required. → See "Cleaning the spray nozzle", page 28
Monthly	<ul style="list-style-type: none">Rinse the spray nozzle under running water to remove foreign substances.Clean the WC ceramic appliance with Geberit AquaClean cleaning agent. → See "Cleaning the flushing area of the WC ceramic appliance", page 29

Targeted disinfection

Disinfection is only recommended if there is a definite risk of infection as a result of germs.

ATTENTION

Surface damage caused by aggressive disinfectants

- ▶ Only use alcohol-based disinfectants that are also suitable for hand and skin disinfection.
- ▶ Observe the safety notes from the manufacturer when handling hazardous substances.

Type of disinfection	Disinfection procedure
Wet wipe disinfection For use on smooth surfaces that can be rubbed	<ul style="list-style-type: none">▶ Moisten all surfaces with disinfectant.▶ Allow the disinfectant to take effect according to the manufacturer information.▶ Then rub the surfaces with single-use towels.
Spray disinfection Only for use on surfaces that are not easily accessible and cannot be rubbed	<ul style="list-style-type: none">▶ Spray the difficult-to-reach surface with disinfectant until wet.▶ Allow the disinfectant to take effect according to the manufacturer information.

Suitable cleaning agents and cleaning equipment

ATTENTION

Damage to the device from aggressive descaling agents





- ▶ Only use Geberit AquaClean descaling agent in the device.



ATTENTION

Surface damage caused by aggressive and scouring cleaning agents

- ▶ Use Geberit AquaClean cleaning agents.

The Geberit AquaClean cleaning set includes a ready-made cleaning agent that is optimal for cleaning all Geberit AquaClean surfaces.

Symbol	Characteristics of suitable cleaning agents
	Skin-friendly
	Cleaning agents are permitted to have a low acid content, e.g. heavily diluted citric acid
	Low-foaming
	Liquid
	Water-dilutable

Symbol	Suitable cleaning equipment
	Soft, fine-pored sponges
	Lint-free, soft cloths which are free of dust
	Toilet brush

Device descaling message

The device can be configured for the local water hardness in accordance with the following table via the Geberit AquaClean app. This adaptation prevents unnecessary descaling procedures and helps protect the environment. Nevertheless, regular descaling of the device is required.

Range	°fH	°dH	°eH
soft	≤ 15	≤ 8	≤ 11
medium	15–25	8–14	11–18
hard	> 25	> 14	> 18

i The device can continue to be used normally if the LED on the lateral control panel lights up red. Descaling should be carried out soon.

Frequency	Message	Fault clearance
At least once a year	<ul style="list-style-type: none"> The LED on the control panel lights up red. The Geberit AquaClean app displays the descaling message. 	<ul style="list-style-type: none"> ▶ Perform descaling.
Maximum number of shower cycles depending on the water hardness reached		
Double the maximum number of shower cycles depending on the water hardness reached	<ul style="list-style-type: none"> The LED on the control panel flashes red. The Geberit AquaClean app displays the descaling message. 	<p>Prerequisite</p> <ul style="list-style-type: none"> – A shower procedure is no longer possible without descaling. <ul style="list-style-type: none"> ▶ Perform descaling.

Removing the WC lid

1 Lift the WC lid.



2 Remove the WC lid.

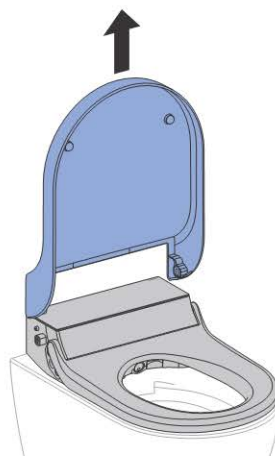

Descaling the device

ATTENTION

Damage to the device from aggressive descaling agents

- ▶ Only use Geberit AquaClean descaling agent in the device.



- You will need to descale the device at least once a year, or more often depending on the number of shower cycles.
- During the descaling procedure, you can continue to use the WC without the spray functionalities.
- The descaling procedure lasts up to 30 minutes. Once the orange LED switches off, the spray functionality is once again ready for operation.
- Remove splashes of Geberit AquaClean descaling agent immediately with a damp cloth.

Prerequisite

- The LED on the lateral control panel lights up red or it lights up orange and flashes red at the same time.
- The WC lid is removed.

- 1 Remove the design cover.

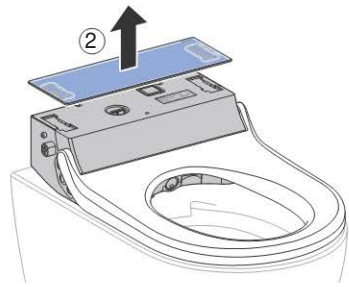
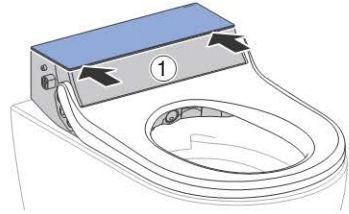

- 2 Remove the plug.

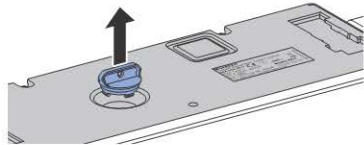

- 3 Press and hold the <--> and <Shower> buttons at the same time for more than 5 seconds on the lateral control panel.



- ✓ The LED on the lateral control panel flashes orange and red at the same time.

- 4** Pour around half a bottle of Geberit AquaClean descaling agent into the device.

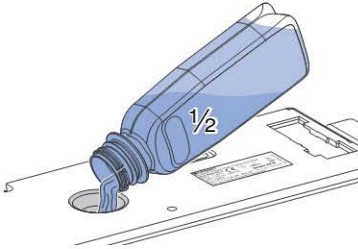

- 5** Press the <Shower> button on the lateral control panel.
- ✓ The LED lights up orange.
 - ✓ The device processes the descaling agent and a small quantity runs into the WC ceramic appliance. After around 15 seconds, the LED on the lateral control panel flashes orange and red at the same time.

- 6** Pour the remainder of the Geberit AquaClean descaling agent into the device.

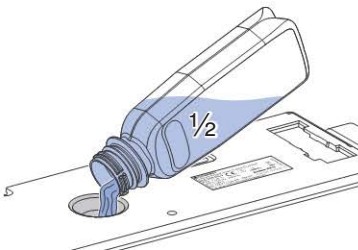

- 7** Re-insert the plug.

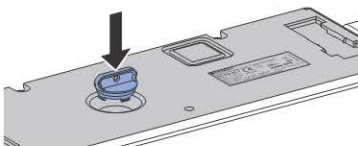

- 8** Mount the design cover.

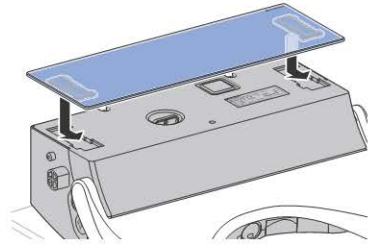

- 9** Mount the WC lid.

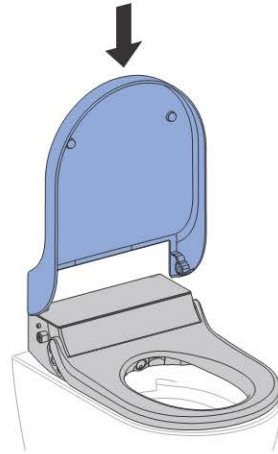

- 10** Press the <Shower> button.



- ✓ The LED lights up orange until the descaling programme is complete. Once the LED switches off, the device is once again ready for operation.

Cleaning the WC lid, WC seat ring and housing

i Be careful not to scratch the surface of the WC seat. Always place the components on a soft, non-scratching underlay.

1 Spray the surfaces with Geberit AquaClean cleaning agent. Wipe the surfaces with a soft, lint-free, damp cloth.

2 Open the WC lid.

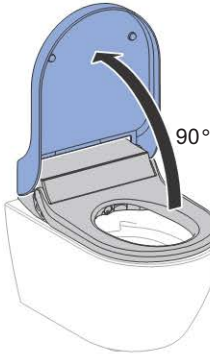

3 Remove the WC lid.

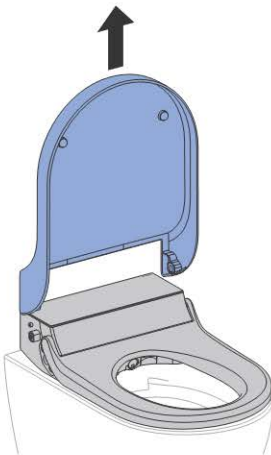

4 Remove the design cover for complete cleaning.

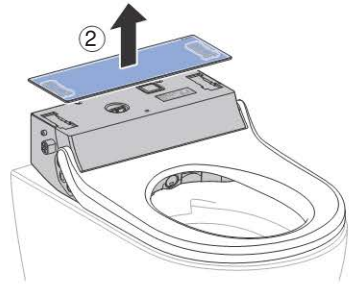
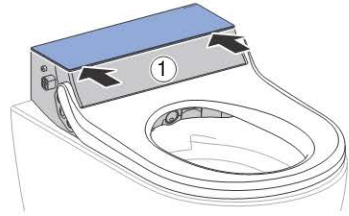

5 Spray the WC lid and the WC seat with Geberit AquaClean cleaning agent. Wipe the surfaces with a soft, lint-free, damp cloth.

6 Then dry all surfaces with a soft, lint-free cloth.

7 After cleaning is complete, re-assemble the device in reverse order of disassembly.

Cleaning between the device and the WC ceramic appliance



WARNING

Danger of fatal electric shock
Water can flow into the device when it is moved without a removal limiter (safety line).

- ▶ Do not cut or damage the line of the removal limiter.
- ▶ Do not manipulate or remove the removal limiter.

1 Switch off the device.

2 Remove the device from the base plate.

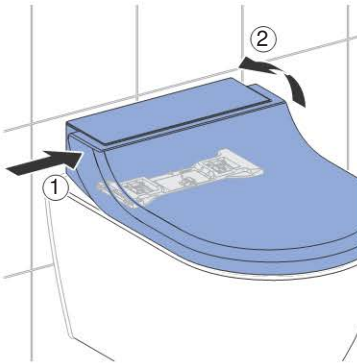

3 Lift the device as far as the removal limiter permits. Clean the gap between the shower toilet and ceramic sanitary appliance.

4 Mount the device on the base plate. Ensure that it is safely engaged.

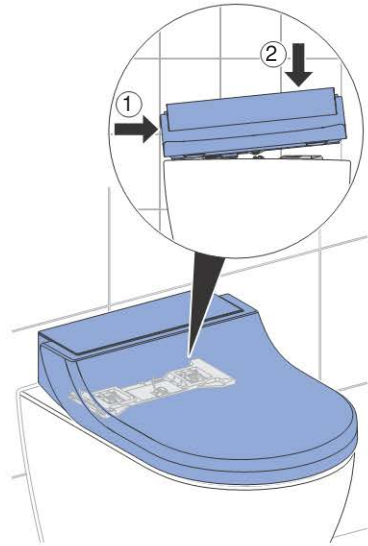

5 Switch on the device.

Cleaning the spray nozzle



- For cleaning, use a soft, lint-free cloth.
- Geberit AquaClean cleaning agent is particularly suitable for all surfaces of the device.

1 Lift up the WC lid and the WC seat ring.

2 Press the <+> and <Shower> buttons at the same time.

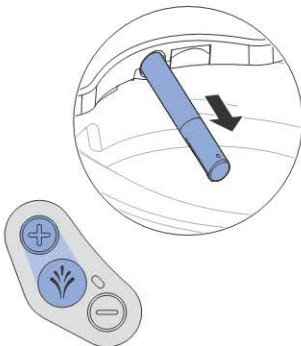

✓ The spray arm extends fully.

3 Hold the spray arm firmly and remove the spray nozzle from the front to clean and descale it. Always ensure that the spray nozzle moves parallel to the spray arm.

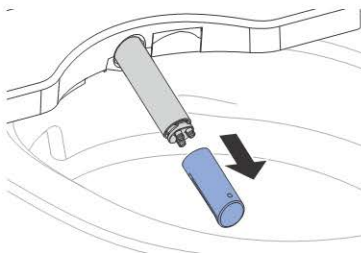

4 Replace the spray nozzle if it can no longer be completely cleaned and descaled.

5 Spray the spray arm with Geberit AquaClean cleaning agent. Then rinse it thoroughly with warm water.

6 Dry the spray nozzle carefully.

7 Mount the spray nozzle.

8 Press the <Shower> button.



✓ The spray arm retracts fully. The cleaning procedure is now complete.

Cleaning the flushing area of the WC ceramic appliance

- 1** Spray the WC ceramic appliance with Geberit AquaClean cleaning agent and allow the cleaning agent a few minutes to take effect.

- 2** Finally, rinse the WC ceramic appliance with water.

- 3** Remove stubborn stains with a toilet brush.

Troubleshooting

The shower toilet is not functioning

The following table will help you with troubleshooting if the shower toilet is without function.



DANGER

Danger of fatal electric shock

- ▶ Do not open the device.
- ▶ Do not attempt to repair the device yourself.
- ▶ Do not modify the device.
- ▶ Do not replace damaged mains connection cables yourself.



The shower toilet can be used as a normal toilet even in the event of a malfunction. The spray arm must be fully retracted. You start the toilet flush as usual by pressing the buttons on the cistern.



If the device is defective, switch it off using the power switch.

Step	Description of problem	Fault clearance
1	The shower toilet and the status LED are without function.	<ul style="list-style-type: none">▶ Switch the device off and on again. → See "Switching the device on and off", page 13 Result <ul style="list-style-type: none">✓ The device re-initialises.
2	The fuse or residual-current device in the electrical distributor trips once.	<ul style="list-style-type: none">▶ Replace or reset the fuse in the electrical distributor.▶ Reset the residual-current device in the electrical distributor. Result <ul style="list-style-type: none">✓ The device initialises again after switching on. Using the device does not trip any fuses or residual-current devices.
3	The fuse or residual-current device in the electrical distributor trips repeatedly when the device is used.	<ul style="list-style-type: none">▶ Disconnect the mains plug (if available).▶ Replace or reset the fuse or residual-current device in the electrical distributor.▶ Contact customer service. Result <ul style="list-style-type: none">✓ The device is defective.
4	The product has an unknown technical defect.	<ul style="list-style-type: none">▶ Trip the fuse or residual-current device in the electrical distributor.▶ Disconnect the mains plug (if available).▶ Contact customer service.▶ Have the power supply tested by a skilled person.

Other functional errors

The following table will help you with troubleshooting if individual functions of the shower toilet have failed.



The shower toilet can be used as a normal toilet even in the event of a malfunction. The spray arm must be fully retracted. You start the toilet flush as usual by pressing the actuator buttons.



If the device is defective, switch it off using the power switch.

Step	Description of problem	Fault clearance
1	The device does not work at all or partly incorrectly.	<ul style="list-style-type: none"> ▶ Switch off the shower toilet at the power switch for 30 seconds. ▶ Switch on the shower toilet at the power switch. <p>Result</p> <ul style="list-style-type: none"> ✓ The device initialises again after switching on.
2	The cleaning effect of the shower has weakened.	<ul style="list-style-type: none"> ▶ Clean or replace the spray nozzles. → See "Cleaning the spray nozzle", page 28 ▶ Descale the device. → See "Descaling the device", page 24
3	When using the shower function, the shower toilet no longer reaches the usual temperature.	<ul style="list-style-type: none"> ▶ Descale the device. → See "Descaling the device", page 24 ▶ Switch off the shower toilet at the power switch for 30 seconds. ▶ Switch on the shower toilet at the power switch. <p>Result</p> <ul style="list-style-type: none"> ✓ The device initialises again after switching on.

Sustainability

Geberit Group and sustainability

As the European market leader in the sanitary industry, Geberit stands for water saving, resource efficiency and sustainable building. The Group has proven for decades that long-term business success is compatible with environmentally friendly actions and social policies. A company management geared to sustainability helps to save costs while minimizing risks at the same time. Geberit aims to act as a role model and set standards for its customers, suppliers and other partners. This means creating water-saving and sustainable products, using safe, environmentally friendly and resource-efficient production practices, engaging in purchasing and logistics activities with high environmental and ethical standards, and offering excellent working conditions for more than 12 000 dedicated and highly qualified employees worldwide. One way in which the company is showing its awareness of social responsibility is by participating in water relief projects around the world.

Ecodesign – ecobalance

The basis for sustainable products is formed by a systematic innovation process in which product materials and functional principles are chosen that are as environmentally friendly as possible, risks are minimised and a high degree of resource efficiency is strived for. We can supply a detailed ecobalance for this product upon request.

Tips for reducing the ecological footprint

This product was developed with the utmost care, also with regard to the consumption of energy, water and resources (see also technical data). You can reduce the ecological footprint of the product by observing the following recommendations:

- Switch off the device when you go on holiday.
- Interrupt the spray functionality manually in order to save hot water.
- Use small amounts of paper for drying.
- Switch off the heating function of the water heater when you do not need warm shower water.
- Use environmentally friendly cleaning agents.
- Carry out regular maintenance on the device and handle it with care in order to extend the service life.
- Return defective devices to Geberit or a designated partner for appropriate disposal.

Constituents

This product conforms to the requirements of the directive 2011/65/EU:2011-06-08 (Directive on the Restriction of the Use of Certain Hazardous Substances in Electrical and Electronic Equipment) and is free from environmental pollutants such as lead, mercury, cadmium and chrome VI.

The European chemical regulation EC Regulation 1907/2006:2006-12-18 (Regulation on the Registration, Evaluation, Authorisation and Restriction of Chemicals (REACH)), which regulates the registration, assessment, approval and restriction of certain chemical substances, is also complied with.

Disposal of old electrical and electronic equipment



In accordance with Directive 2012/19/EU:2012-07-04, manufacturers of electrical equipment are obliged to take back old equipment and to dispose of it appropriately. The symbol indicates that the product cannot be disposed of with non-recyclable waste. Old equipment should be returned directly to Geberit where it will be disposed of appropriately. Addresses to which equipment can be returned can be requested from the relevant Geberit sales company.

End user warranty

End user warranty

The following end user warranty is provided in addition to and does not affect your contractual partner's liability for defective products.

The Geberit company ("Geberit") responsible for the place of installation of the Geberit AquaClean product ("product") shall provide the end user with a warranty for the product identified by the serial number on the warranty card. The scope of this warranty is as follows:

1. Geberit guarantees that the product shall be free from material defects and manufacturing faults for a period of 3 years ("warranty period") calculated from the installation date at the end user's premises. Warranty scope:
 - a) Within the first 2 years of the warranty period, a customer service representative authorised by Geberit shall rectify any material defects or manufacturing faults free of charge by repairing or replacing the defective parts.
 - b) In the third year of the warranty period, Geberit shall supply replacements for defective parts free of charge to the customer service representative authorised by Geberit and contracted by the end user to repair the product.
2. The end user shall not be entitled to assert more extensive claims against Geberit on the basis of this warranty.
3. Claims can only be made under the warranty if:
 - a) The product has been installed and put into operation by an installation company or by customer service personnel authorised by Geberit.
 - b) No modifications have been made to the product; in particular, no parts have been removed, replaced or added.
 - c) The product defect has not been caused by improper installation or use, nor can it be attributed to inadequate care or maintenance.
 - d) Claims shall only be made during the third year of the warranty period if the end user has completed the enclosed warranty card in full and returned it to the Geberit company responsible for the place of installation within 90 working days of the installation date.
4. This warranty applies solely to places of installation in countries in which Geberit has its own sales company or is represented by a sales partner.
5. The warranty is exclusively subject to the substantive law of the country in which Geberit has its place of business. The United Nations Convention on Contracts for the International Sale of Goods is expressly excluded. The exclusive place of jurisdiction for all disputes arising from or in connection with this warranty is the location of Geberit's headquarters.

Technical data and conformity

Technical data

Nominal voltage	230 V AC
Mains frequency	50 Hz
Power consumption	2000 W
Power consumption standby	≤ 0.5 W
Protection degree	IPX4
Protection class	I
Mains connection	Mains connection via system plug with flexible three-wire sheathed cable
Spray time	50 s
Number of shower pressure settings, shower spray	5
Water temperature	37 °C
Operating temperature	5–40 °C
Flow pressure	50–1000 kPa
	0.5–10 bar
Minimum flow pressure	0.5 bar
	50 kPa
Calculated flow rate	0.02 l/s
Maximum load, WC seat	150 kg

Declaration of conformity

You can obtain a copy of the declaration of conformity from your responsible Geberit sales company.

(CH) Geberit Vertriebs AG

Schachenstrasse 77
CH-8645 Jona
T 0848 882 982
www.geberit-aquaclean.ch

(DE) Geberit Vertriebs GmbH

Kundendienst / Servicestelle
Theuerbachstrasse 1
D-88630 Pfllendorf
T (075 52) 934 10 11
F (075 52) 934 866
www.geberit-aquaclean.de

(AT) Geberit Vertriebs GmbH & Co. KG

Geberitstrasse 1
A-3140 Pottenbrunn / St. Pölten
T (01) 577 11 77
F (01) 577 11 77 - 21
www.geberit-aquaclean.at

(AE) Geberit International Sales AG

Dubai Branch
B702-B705
Building No. 1
Dubai Design District
PO Box
UAE-282317 Dubai
T +971 4 204 5477
F +971 4 204 5497
www.geberit.ae

(BE) Geberit nv

Beaulieustraat 6
B-1830 Machelen
T +32 2 252 0111
F +32 2 251 0867
www.geberit-aquaclean.be

(BG) Юнитрейд Интернешънъл ЕООД

бул. "Черни връх" 161-A
1407 София
T 02/ 968 11 11
F 02/ 968 10 01
www.unitrade-bg.com

(CN) 吉博力(上海)贸易有限公司

地址: 上海市嘉定区南翔高科
技园区惠平路1515号
邮编: 201802

(CZ) Geberit spol. s r.o.

Sokolovská 2408/222
190 00 Praha 9
T +420 547 212 335
F +420 547 212 340
www.geberit.cz

(DK) Geberit A/S

Lægårdsvej 26
DK-8520 Lystrup
T +45 86 74 10 86
F +45 86 74 10 98
www.geberit-aquaclean.dk

(ES) Geberit, S.A.U.

Plaza Europa, 2 - 4, 6ª planta
ES-08902 L'Hospitalet del Llobregat
(Barcelona)
T +34 902 170 635
www.geberit-aquaclean.es

(FI) Geberit Oy

Tahkotie 1
FI - 01530 VANTAA
P +358 9 867 8450
www.geberit.fi

(FR) Geberit France

ZA du Bois Gasseau - CS40252 Samoreau
FR-77215 Avon Cedex
Téléphone 01 60 71 66 61
T +33(0)825 801 603
F +33(0)825 801 604
www.geberit-aquaclean.fr

(GB) Geberit Sales Ltd.

Geberit House
Edgehill Drive
Warwick
CV34 6NH
T (0)1926 516 800
T (0)1926 516 809
In Eire T +44 1622 717 811
www.geberit-aquaclean.co.uk

(HR) Predstavništvo Geberit

prodaja d.o.o. Ruše
Samoborska cesta 218
10090 Zagreb, HR
T +385 1 3867 800
F +385 1 3867 801
www.geberit.hr

(HU) Geberit Kft

1117 Budapest,
Aliz utca 2.
T +36 1 204 4187
www.geberit.hu

(IT) Geberit Marketing e Distribuzione SA

Via Gerre 4
CH-6928 Manno
T +41 91 611 92 92
F +41 91 611 93 93
www.geberit-aquaclean.it

(LU) Geberit Luxembourg

61, avenue de la Libération
L-3850 Schifflange
T +352 54 52 26
F +352 54 54 91
www.geberit.lu

(NL) Geberit B.V.

Fulltonbaan 15
3439 NE Nieuwegein
T +31 (0)3060 57700
F +31 (0)3060 53392
www.geberit-aquaclean.nl

(NO) Geberit AS

Luhrtoppen 2
N-1470 Lørenskog
T +47 67 97 82 00
www.geberit-aquaclean.no

(PL) Geberit Sp. z o.o.

ul. Postępu 1
02-676 Warszawa
T +48 22 843 06 96
www.geberit-aquaclean.pl

(PT) Geberit Tecnologia Sanitária, S.A

Rua Cupertino de Miranda, nº 12 - 2ª A
PT-1600-485 LISBOA
www.geberit.pt

(RO) Geberit International Sales AG

Splaiul Unirii, Nr. 86, Et. 3
Sector 4, Bucharest
T +40 21 330 30 80/81
F +40 21 330 31 61
www.geberit.ro

(RS) Geberit - Predstavništvo za

Republiku Srbiju i Republiku Crnu Goru
Vojvode Skopljanca 24
SR - 11000 Beograd
T + 381 11 30 96 430
F + 381 11 30 96 431
www.geberit.rs

(RU) ООО „ГЕБЕРИТ РУС“

Олимпийский пр., 16, стр.5, 5 этаж
129110 Москва
тел.: +7 495 783 83 30
www.geberit.ru

(SE) Geberit AB

Folketshusgatan 1
Box 140
295 22 Bromölla
T +46 40 680 89 30
www.geberit.se

(SI) Geberit prodaja, d.o.o.

Bezena 55
2342 Ruše
T 01 586 22 00
F 01 586 22 19
www.geberit.si

(SK) Geberit Slovensko s.r.o.

Karadžičova 10
821 08 Bratislava 2
T +421 2 49 20 30 71
www.geberit.sk

(TR) Geberit Tesisat Sistemleri Tic Ltd. ti.

Iğerenköy Mah. Engin Sok. No. 10,
34752 Atasehir- Ystanbul, Turkey
T +90 216 340 82 73
F +90 216 340 82 79
www.geberit.com.tr

(ZA) Geberit Southern Africa (Pty.) Ltd.

6 Meadowview Lane,
Meadowview Business Estate,
Longmeadow,
Linbro Park
Johannesburg, South Africa
T +27 11 444 5070
F +27 11 444 5992
www.geberit.co.za