

Before operating the unit, please read this manual thoroughly,
and retain it for future reference.



Owner's
Instructions



We Bring Wellness
Coway

BA13-AR/AE
BA13-BR/BE

Bidet



PRODUCT FEATURES

BA13-AR/AE/BR/BE Common Functions

1. Instant warm water system

The water is instantly heated when using the rear and front cleaning functions so that you can immediately use water at your desired temperature.



2. Air+ function

The water stream with air bubbles provides softer, stronger cleansing.



3. MESH Filter

The MESH filter is a semi-permanent item. You can use the filter repeatedly by cleaning it.



4. Eco mode

- Bidet eco mode: If the seat sensor does not detect someone sitting down or no panel or remote control button is pressed for approximately 10 minutes, the seat temperature is set to 'L', so that power consumption is reduced. When bidet eco mode is activated, the eco mode indicator on the front is turned on.



- Remote control eco mode: If no remote control button is pressed for approximately 5 seconds, the remote control display is turned off to reduce the power consumption of the remote control battery.

5. Stainless steel twin nozzle adopted for enhanced hygiene

By adopting Stainless steel nozzles, you can use the product more hygienically. In addition, the separation of the cleansing nozzle and the bidet nozzle ensures extra hygiene.



6. Wide Water Stream

A widely spread water stream applied to the cleaning water for smoother cleaning.

Additional functions for the BA13-BR/BE

1. Wide function

You can directly select the degree of spread of the cleansing water from a strong flow of water to a soft, spread-out water flow when using rear and front cleansing.



2. Deodorization function

Once the seat sensor detects a person sitting, the deodorization function automatically deodorizes odors for 1 minute. After using the bidet, the deodorization function will remain on for 3 minutes ensuring a refreshed feeling.



3. Sterilization function using oxidized silver

This bidet sterilizes the nozzle with oxidized silver sterilizing water.



CONTENTS

PRODUCT FEATURES	01	INSTALLING YOUR BIDET	17
CONTENTS	01	Removing existing toilet seat	17
SAFETY PRECAUTIONS	02	Installing the product	17
PART NAMES	07	Installing the remote control wall mount	19
Dimensions	07	Cleaning and maintaining your bidet	20
Front / Rear view	08	Cleaning the nozzles	20
Remote control	08	Cleaning the product body	20
Installation parts	09	Removing the product	21
Check before using your product	10	Cleaning the MESH filter	21
Please keep in mind!	10	SPECIFICATIONS	23
Configuring a special mode	11	TROUBLESHOOTING	24
Checking the control panel	12	WARRANTY CARD	25
Using your bidet	15		
Using the rear nozzle	15		
Using the front nozzle	16		

SAFETY PRECAUTIONS

IMPORTANT SAFETY GUARDS

⚠ DANGER: If not observed, serious injury or even death may occur as a result of electrocution.

⚠ WARNING: If these warnings are not observed, considerable physical injury or property damage may occur as a result of burns, electrocution, fire, or injury.

⚠ CAUTION: If these cautions are not observed, slight physical injury or property damage may occur.

READ ALL INSTRUCTIONS BEFORE USING.
Save these instructions for future reference.

When using electrical products, especially when children are present, basic safety precautions should always be followed:

⚠ DANGER:

- Do not use a damaged power plug or loose electric outlet. This may result in electric shock or fire.
- Make sure to use a dedicated electrical outlet. Failing to do so may result in electric shock or fire.
- Do not move the product by pulling the power cord. This may result in electric shock or fire.
- Do not handle the power plug with wet hands. This may result in electric shock or fire.
- Do not forcefully bend the power cord or place heavy objects on it to prevent it from being damaged or deformed. This may result in electric shock or fire.
- Do not connect and pull out the power plug repeatedly. This may result in electric shock or fire.
- Unplug the product before repairing, inspecting, or replacing parts. Failing to do so may result in electric shock or fire.
- Remove any dust or water from the power plug. Failing to do so may result in electric shock or fire.
- Do not plug the appliance into an electrical outlet or power strip that is being used by several other appliances. Use an electrical outlet dedicated to the product. Failing to do so may result in fire.
- Unplug the system if it is not being used for a long period of time. Failing to do so may result in electric shock or fire.
- Do not attempt to repair or modify the power cord. This may result in electric shock or fire.
- If the power cord is damaged, do not replace the cord yourself. Call a Coway Service Center to have it replaced. Failing to do so may result in electric shock or fire.

SAVE THESE INSTRUCTIONS



SAFETY PRECAUTIONS



DANGER:

- If the product produces a strange noise, a burnt smell, or emits smoke, unplug it immediately from the electrical outlet and call our service center. Failing to do so may result in electric shock or fire.
- Do not insert a wire or sharp object in any product gaps or the warm air outlet. This may result in electric shock, fire, or product damage.
- Do not place an electric heater near the product or dispose of any burning materials such as a lit cigarette in the toilet. This may result in fire or product deformation.
- Do not place any containers filled with water, medicine, food, any metallic objects, or any flammable material on top of the product. If foreign material enters the product, this may result in electric shock or fire.
- Do not use the product in locations exposed to excessive moisture and do not splash water onto the product. This may result in electric shock or fire.
- Do not use the product if it is not working properly.
 - * Please unplug the product immediately, and call our service center after closing the main water supply valve. Failing to do so may result in electric shock or fire.
- While taking a shower or cleaning the bathroom, pull the power plug out of the electrical outlet and exercise caution that water or detergent does not splash onto the bidet. Failing to do so may result in electric shock or fire.
 - * If foreign material enters the product, pull the power plug out of the electrical outlet, turn off the main water valve, and call the Coway Service Center.
- Do not drop the remote control. This may result in product damage or a malfunction.
- Do not separate the seat from the bidet. This may result in electric shock, fire, or product damage.
- Do not disassemble, repair, or modify the product yourself. This may result in electric shock, fire, or product damage.
- Do not use the product while bathing.
- Do not place or store the product where it can fall or be pulled into a tub or sink.
- Do not place in or drop the product into water or any other liquid.
- Do not reach for the product if it has fallen into water. Unplug the product immediately.

SAVE THESE INSTRUCTIONS

SAFETY PRECAUTIONS

WARNING:

- Do not operate or store the unit in locations where flammable or combustible materials are used. This may result in electric shock or fire.
- Use main water supply as the supplied water. Industrial water or gray water, if used as supply water may cause skin damage or disease.
- Do not block the warm air outlet with your hand. This may result in burns or fire.
- Please turn off the main water supply valve when cleaning the filter. Failing to do so may result in electric shock or product damage.
- For children, the elderly, and those who cannot adjust the temperature themselves or have sensitive skin, set the warm water temperature and seat temperature to 'L.' Failing to do so may result in low temperature burns.
 - ※ About 'low temperature burns': This refers to burns inflicted by making contact with temperatures around 40 °C for an extended period of time).
- Do not press the buttons using excessive force. This may result in product damage or a malfunction.
- Do not stand or place a heavy object on the seat cover. This may result in product damage or a malfunction.
- Close supervision is necessary when this product is used by children or persons requiring general assistance.
- Use this product for its intended use only, as described in this manual. Do not use attachments not recommended by the manufacturer.
- Never operate this product if it has a damaged cord or plug, if it is not working properly, if it has been dropped or damaged, or dropped into water. Return the product to a service center for examination and repair.
- Keep the cord away from heated surfaces.
- Never block the air openings of the product or place it on a soft surface, such as a bed or couch, where the air openings may be blocked. Keep the air openings free of lint, hair, etc.
- Never use the product while sleeping or when drowsy.
- Never drop or insert any object into any opening or hose.
- Do not use the product outdoors or operate where aerosol (spray) products are being used or where it could be exposed to oxygen.
- Connect this product to a properly grounded outlet only. Refer to the Grounding Instructions.
- Unplug this product before filling. Fill (reservoir) with water only unless otherwise specified by the manufacturer. Do not overfill (or specify filling instructions).

SAVE THESE INSTRUCTIONS





SAFETY PRECAUTIONS



CAUTION:

- Do not connect the main water to the hot water pipe. This may result in a malfunction or accident (Make sure to connect it to the cold main water supply pipe).
- After the installation, make sure to check the water supply connections for leaks. Rubber packing should be applied to the connection hose.
- Do not install the air purifier in a location exposed to direct sunlight. This may result in deformation or discoloration.
- Do not open/close the seat cover using excessive force or lean on the cover. This may result in product damage or a malfunction or physical injury.
 - * The seat cover closes/opens slowly using the 'soft opening/closing' method.
- Exercise caution that urine does not come into contact with the nozzles, air dryer outlet, or the outside surface of the product. Failing to do so may result in bad odors or malfunctions.
- If the product will not be used for a long period of time, pull the power plug out of the electrical outlet, close the main water supply valve, and drain the water in the water tank.
- Do not pull out the bidet hose or connection hose using excessive force. This may result in a leak or malfunction.
- Pull the power plug out of the electrical outlet before cleaning the unit. Do not splash water directly onto the bidet, or use thinner, benzene, chemicals, or hydrochloric acid detergent. This may result in corrosion to the metal parts or discoloration or scratches to the bidet body.
 - * Use a soft cloth or sponge to clean the bidet.
- This appliance is not intended for use by persons [including children] with reduced physical, sensory or mental capabilities, or lack of experience and knowledge, unless they have been given supervision or instruction concerning use of the appliance by a person responsible for their safety. Children should be supervised to ensure that they do not play with the appliance.

SAVE THESE INSTRUCTIONS

SAFETY PRECAUTIONS

GROUNDING INSTRUCTIONS

- This product should be grounded. In the event of an electrical short circuit, grounding reduces the risk of electric shock by providing an escape route (wire) for the electric current. This product is equipped with a cord consisting of a grounding wire with a grounding plug. The plug must be plugged into an outlet that is properly installed and grounded.

⚠ The improper use of the grounding plug can result in electric shock.

- If the repair or replacement of the cord or plug is necessary, do not connect the grounding wire to either flat blade terminal. The insulation wire with an outer green surface with or without yellow stripes is the grounding wire.
- Check with a qualified electrician or service technician if you do not understand the grounding instructions completely, or if in you are in doubt whether the product is properly grounded.

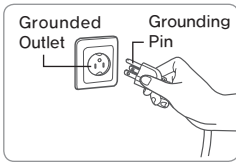

- This product is for use on a nominal 120V circuit, and has a grounding plug that looks like the plug illustrated in Figure 1.

Figure 1

Extension cord

If it is necessary to use an extension cord, use only a three wire extension cord with a three-blade grounding plug, and a three-slot receptacle that will accept the plug of the product. Replace or repair a damaged cord immediately.

SAVE THESE INSTRUCTIONS



PART NAMES

Dimensions

The bidet has the following dimensions.

Do not install the bidet when the dimensions of the bidet differ from those of the toilet.

>> BA13-AR/BR (Round shape)

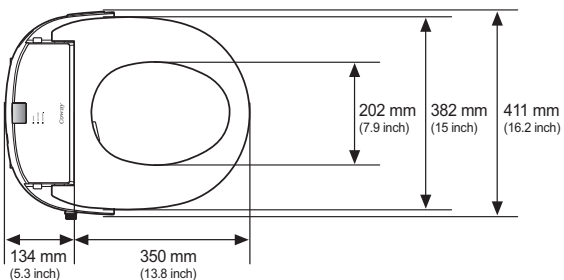

>> BA13-AE/BE (Elongated shape)

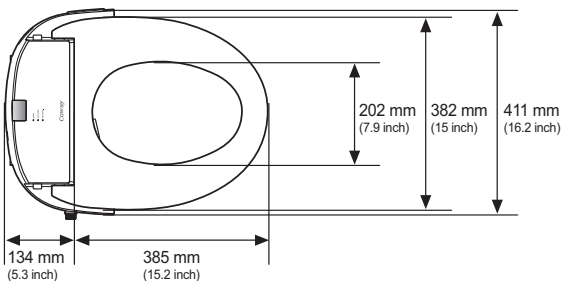

>> Bottom view

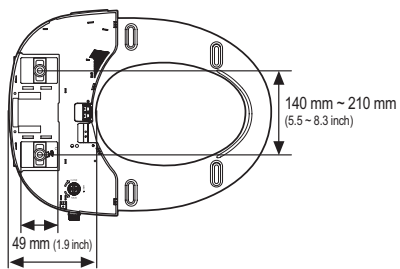

>> Distance between fixing holes

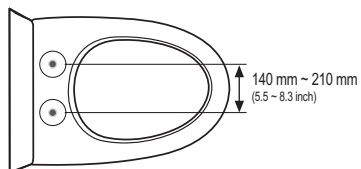

PART NAMES

Front / Rear view

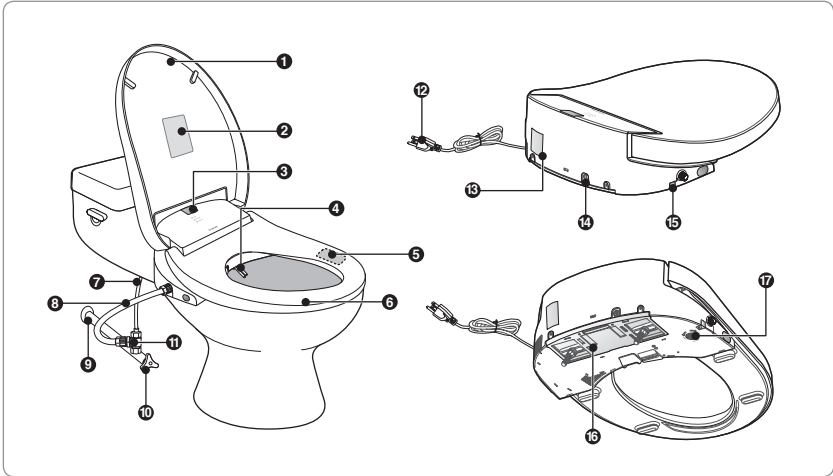

- 1 Seat cover
- 2 Warning sticker
- 3 IR sensor
- 4 Nozzle
- 5 Seat sensor
- 6 Bidet seat
- 7 Water tank hose
- 8 Bidet hose
- 9 Main water supply pipe
- 10 Main water supply valve
- 11 T-shaped connector
- 12 Power cord
- 13 Product sticker
- 14 Drain plug
- 15 Button
- 16 Installation plate
- 17 MESH filter

Remote control

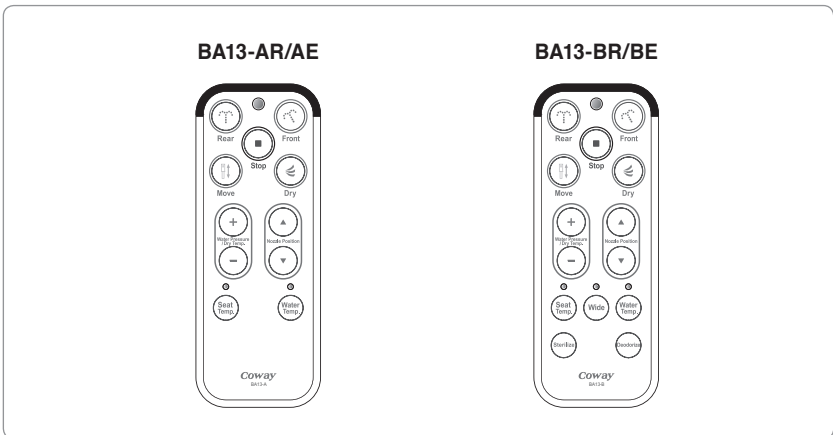

PART NAMES

Installation parts

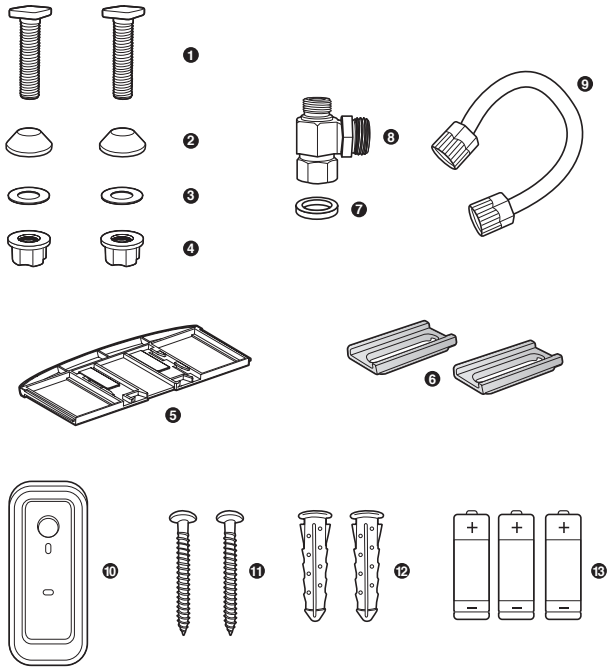

❶ 2 fixing screws

❷ 2 fixing rubbers

❸ 3 fixing washers

❹ 2 fixing nuts

❺ Installation plate

❻ 2 fixing sliders

❼ Rubber packing

❽ T-shaped connector

❾ Bidet hose

❿ Remote control wall mount
(including the sticker for
attachment)

⓫ 2 screws

⓬ 2 anchors

⓭ 3 batteries (AAA)

CHECK BEFORE USING YOUR PRODUCT

Please keep in mind!

■ Connect the power.

Plug the power cord into the electrical outlet. The bidet only works normally when the electricity is connected.



Tips

- ▶ This product is for 120 V~ / 60 Hz only. Make sure to connect the power plug to a grounded electrical outlet (120 V~ / 60 Hz) dedicated to the product.

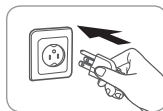

■ Open the main water supply valve.

The bidet only works normally when water is supplied.

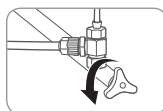

■ Check whether the product is in eco mode before using it.

- If the seat sensor does not detect anyone sitting down or no panel or remote control button is pressed for approximately 10 minutes, bidet eco mode is activated, the eco mode indicator is turned on, and the seat temperature is set to 'L' to reduce the power consumption of the product.
- When sitting down on the seat or pressing a panel button, the power indicator is turned on, the eco mode indicator is turned off and the seat temperature returns to the last configured temperature.
- Even if you sit down on the seat or press a panel button, the power indicator is not turned on. This means that the power is turned off. In this case, press the power selection button to turn the power on before using it.

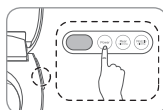
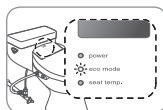

■ After the installation

Check if water leaks from the main water supply valve or the connecting hose. You must insert the rubber packing between the T-shaped connection pipe and the main water supply pipe.



■ Cleaning the filter on a regular basis

Clean the MESH filter on a regular basis (The cleaning interval may differ depending on the water quality). If the MESH filter is contaminated by foreign substances, the filter is blocked or non-filtered cleansing water may be ejected.



■ If the bidet has not been used for a long time

When the bidet has not been used for a long time, clean the filter and clean each part of the bidet such as the air dryer outlet, the nozzle and the seat before use (see p.16).



■ Configure and use a special mode according to your preferences.

You can configure one of the special modes (eco mode, seat sensor lock mode, silent mode) according to your preferences (see p.11).

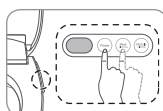

Tips

- ▶ Remove the protective film from the operation part before using it.



CHECK BEFORE USING YOUR PRODUCT

Configuring a special mode

■ Selecting/cancelling silent mode

1. Press and hold down the 'Power' and 'Rear Cleansing' buttons simultaneously for at least 1 second when the power cord is plugged into the electrical outlet (an alarm sound is generated).
2. Set the mode by pressing the 'Power' button on the operation part.
 - If the power indicator is turned on this indicates that silent mode has been set.
 - If the power indicator is turned off, this indicates that silent mode has been canceled.
3. After setting silent mode, and pressing the 'Power' and 'Rear Cleansing' buttons simultaneously or no button is pressed for 10 seconds, the setting is saved and the bidet changes to the standby state (an alarm sound is generated).

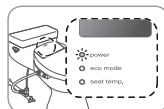
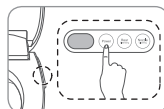

■ Selecting/cancelling bidet eco mode

1. Press and hold down the 'Power' and 'Rear Cleansing' buttons simultaneously for at least 1 second when the power cord is plugged into the electrical outlet (an alarm sound is generated).
2. Set the mode by pressing the 'Rear Cleansing' button on the operation part.
 - If the eco mode indicator is turned on, this indicates that bidet eco mode has been set.
 - If the eco mode indicator is turned off, this indicates that bidet eco mode has been canceled.
3. After selecting bidet eco mode, and you press the 'Power' and 'Rear Cleansing' buttons simultaneously or no button is pressed for 10 seconds, the setting is saved and the bidet changes to the standby state (an alarm sound is generated).

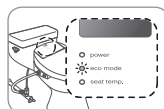
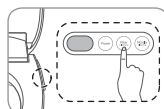

■ Selecting/cancelling seat sensor lock mode

1. Press and hold down the 'Power' and 'Rear Cleansing' buttons simultaneously for at least 1 second when the power cord is plugged into the electrical outlet (an alarm sound is generated).
2. Set the mode by pressing the 'Nozzle Cleaning' button on the operation part.
 - If the seat temp. indicator is turned on, this indicates that seat sensor lock mode has been set.
 - If the seat temp. indicator is turned off, this indicates that seat sensor lock mode has been canceled.
3. After setting seat sensor lock mode, and pressing the 'Power' and 'Rear Cleansing' buttons simultaneously or no button is pressed for 10 seconds, the setting is saved and the bidet changes to the standby state (an alarm sound is generated).

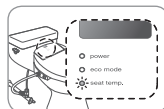
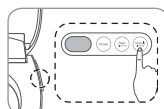

CHECKING THE CONTROL PANEL

* You can use the basic functions such as rear cleansing and nozzle cleaning from the bidet's control panel without using the remote control.

● Display ■ Control panel

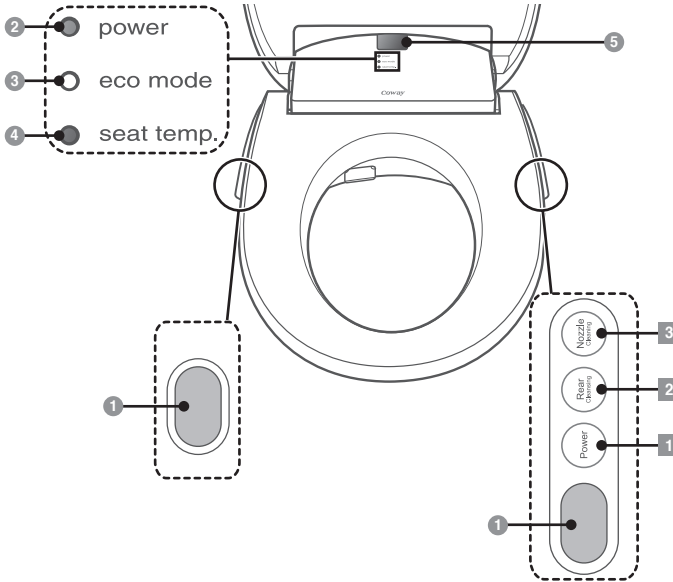

Display

1 Remote control signal receiver
This receives the signals from the remote control.

5 Remote control signal receiver
This receives the signals from the remote control.

● power

○ eco mode

● seat temp.

2 Power indicator
This indicator is turned on when the bidet power is turned on.
* This indicator is turned off when bidet eco mode is activated.

3 Eco mode indicator
If you activate the eco function, this indicator is turned on when eco mode starts.

4 Seat Temperature indicator
This indicator represents the seat temperature.
Indicator on - L/M/H
Indicator off - OFF
* This indicator is turned off when bidet eco mode is activated.

Control panel

1 'Power' button
Turns the product ON/OFF.
Press and hold the button for more than 2 seconds when you turn it off.
* If the 'Power' button is pressed while the front, rear cleansing function is operating, the cleansing function is stopped and the bidet changes to standby mode.

2 'Rear Cleansing' button
Selects the rear cleansing function.

3 The 'Nozzle Cleaning' button
Cleans the nozzle. If you press 'Nozzle cleaning' button, the nozzle is extended fully, and you can clean it conveniently.



CHECKING THE CONTROL PANEL

Display / Control panel

● Display

■ Control panel

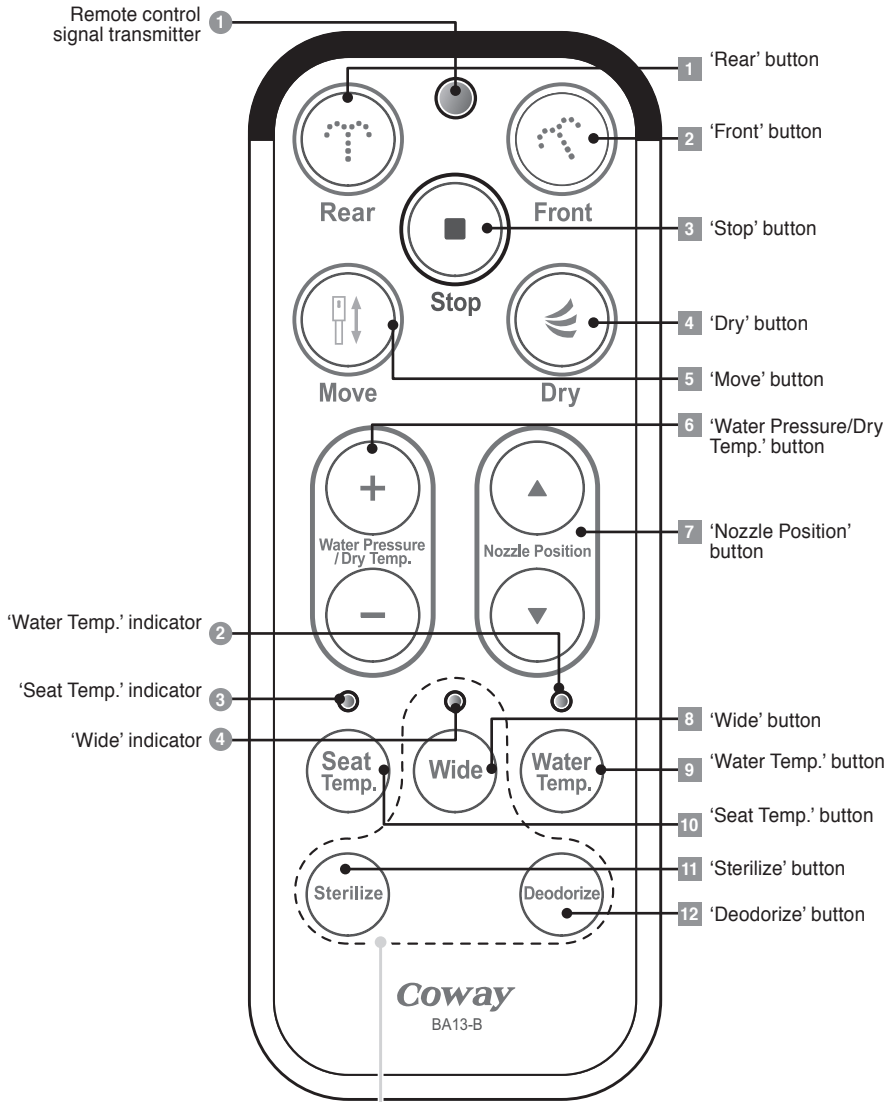

For the BA13-AR/AE, the 'Wide', 'Sterilize' and 'Deodorize' are excluded.

CHECKING THE CONTROL PANEL

Display



- 1 Remote control signal transmitter**
Transmits the signal when a remote control button is pressed.



- 3 'Seat Temp.' indicator**
Whenever the 'Seat Temp.' button is pressed, the temperature control indicator cycles through the following options: L(Blue)→M(Pink)→H(Red)Off.



- 2 'Water Temp.' indicator**
Whenever the 'Water Temp.' button is pressed, the temperature control indicator cycles through the following order: L(Blue)→M(Pink)→H(Red)→Off.



- 4 'Wide' indicator**
Whenever the 'Wide' button is pressed, the indicator cycles through the following options: Straight line (Blue)→Level1(Pink)→Level2(Red).
* For the BA13-BR/BE only

Control panel



- 1 'Rear' button**
Use this button to use the rear cleansing function.



- 3 'Stop' button**
All currently operating functions will stop.



- 5 'Move' button**
Use this button to use the move function. If you press the 'Move' button, as the nozzle is moved back and forth while you operate the rear cleansing/front cleansing function, you can clean a wider area.



- 7 'Nozzle Position' button**
Use this button to control the nozzle position during the rear cleansing/front cleansing operation. You can move the nozzle in 5 levels using the 'Nozzle Position' button.



- 9 'Water Temp.' button**
Use this button to control the water temperature. Whenever the 'Water Temp.' button is pressed, you can control the water temperature in 4 levels (L→M→H→Off).



- 11 'Sterilization' button**
Use this button to perform the sterilization function. Sterilizing water is ejected for 30 seconds to sterilize and clean the nozzle.
* For the BA13-BR/BE only



- 2 'Front' button**
Use this button to use the front cleansing function for women.



- 4 'Dry' button**
Use this button to use the drying function. It helps the drying process after using the rear cleansing/front cleansing function.



- 6 'Water Pressure/Dry Temp.' button**
You can control the water pressure in 3 levels (L→M→H) and control the air dryer temperature in 4 levels (L→M→H→OFF) using the Water 'Pressure/Dry Temp.' button.

* You can control the water pressure when operating the rear cleansing/front cleansing functions and control the air dryer temperature when operating the drying function.



- 8 'Wide' button**
Use this button to control the water ejection range when using the cleansing function. You can select the angle of the water in 3 levels using the Wide function button (Straight Line→Level 1→Level 2). Whenever this button is pressed, the Wide function indicator turns a different color.
* For the BA13-BR/BE only



- 10 'Seat Temp.' button**
Use this button to control the seat temperature. Whenever the 'Seat Temp.' button is pressed, you can control the seat temperature in 4 levels (L→M→H→Off).



- 12 'Deodorization' button**
Use this button to perform the deodorization function. When you press this button, the deodorization function is performed for approximately 1 minute.
* For the BA13-BR/BE only





USING YOUR BIDET



Using the rear nozzle

■ Using the rear nozzle

1. Sit down on the seat and press the 'Rear Cleansing' button on the operation part.
2. Self-cleaning for the rear cleansing nozzle is performed, removing the cold water remaining inside the nozzle before the water stream is ejected so that the water can be set to a desired temperature for cleansing.



Tips

- ▶ The cleansing water ejection time may be delayed while the above functions are performed.

3. The cleansing water is ejected for approximately 1 minute and then stops automatically.
4. Self-cleaning for rear cleansing nozzle is performed for approximately 5 seconds after rear cleansing. Then the nozzle retracts itself.
5. You can adjust the nozzle position by pressing the 'Nozzle Position' button.
6. You can adjust the water ejection angle by pressing the 'Wide' button (for the BA13-BR/BE only).



Tips

- ▶ If the 'Rear Cleansing' button is pressed again during the cleansing operation, the rear cleansing function operates for another 1 minute.
- ▶ While cleansing, users can adjust the water temperature, water pressure, and nozzle position according to their preferences.
- ▶ You can not increase the water pressure level higher than level 2 if your area is in the following conditions.
 - Main water supply temperature under 10 °C and rated power source under 110 V~.
- ▶ If the seat sensor does not detect a human body, the bidet will not work. **220-240V UK**

■ Moving

Press the 'Move' button on the operation part.

- The nozzle moves back and forth, providing a wider range of cleansing.
- * This will operate for as long as the rear cleansing function continues.
- * You can control the nozzle position by pressing the 'Nozzle Position' button.
- * To stop the move function, press the 'Move' button once again.

■ Drying

Press the 'Dry' button on the operation part.

- Warm air is emitted for approximately 2 minutes.
- * If you wipe off the water lightly before turning on the air dryer, drying will finish faster.
- * You can control the air temperature by pressing the 'Dry Temp.' button.
- * If you press the 'Dry' button again during the operation, additional drying starts for another 2 minutes.
- * If you press the 'Dry' button while cleansing, cleansing is stopped and drying starts immediately.

■ Stopping

To stop the current operation, press the 'Stop' button.

- This stops all currently operating functions.
- * The drying function stops 2 seconds after the 'Stop' button is pressed.



USING YOUR BIDET



Using the front nozzle

■ Using the front nozzle

1. Sit down on the seat and press the 'Front Cleansing' button on the operation part.
2. Self-cleaning for the front cleansing nozzle is performed, removing the cold water remaining inside the nozzle before the water stream is ejected so that the water can be set to a desired temperature for cleansing.



Tips

- ▶ The cleansing water ejection time may be delayed while the above functions are performed.

3. The cleansing water is ejected for approximately 1 minute and then stops automatically.
4. Self-cleaning for rear cleansing nozzle is performed for approximately 5 seconds after front cleansing. Then the nozzle retracts itself.
5. You can adjust the nozzle position by pressing the 'Nozzle Position' button.
6. You can adjust the water ejection angle by pressing the 'Wide' button (for the BA13-BR/BE only).



Tips

- ▶ If the 'Front Cleansing' button is pressed again during the cleansing operation, the front cleansing function operates for another 1 minute.
- ▶ While cleansing, users can adjust the water temperature, water pressure, and nozzle position according to their preferences.
- ▶ You can not increase the water pressure level higher than level 2 if your area is in the following conditions.
 - Main water supply temperature under 10 °C and rated power source under 110 V~ .
- ▶ If the seat sensor does not detect a human body, the bidet will not work. **220-240V UK**

■ Moving

Press the 'Move' button on the operation part.

- The nozzle moves back and forth, providing a wider range of cleansing.
- * This will operate for as long as the front cleansing function continues.
- * You can control the nozzle position by pressing the 'Nozzle Position' button.
- * To stop the move function, press the 'Move' button once again.

■ Drying

Press the 'Dry' button on the operation part.

- Warm air is emitted for approximately 2 minutes.
- * If you wipe off the water lightly before turning on the air dryer, drying will finish faster.
- * You can control the air temperature by pressing the 'Dry Temp.' button.
- * If you press the 'Dry' button again during the operation, additional drying starts for another 2 minutes.
- * If you press the 'Dry' button while cleansing, cleansing is stopped and drying starts immediately.

■ Stopping

To stop the current operation, press the 'Stop' button.

- This stops all currently operating functions.
- * The drying function stops 2 seconds after the 'Stop' button is pressed.





INSTALLING YOUR BIDET



Removing existing toilet seat

1. Remove the existing toilet seat ① and seat cover ② by removing the fixing nuts.

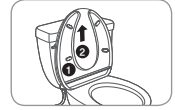

Tips

- ▶ Keep the removed toilet seat in a shaded location to prevent it from being damaged.



Installing the product



Tips

- ▶ As the bidet should be installed on the toilet, ensure that water is not splashed onto the bidet.
- ▶ There may be some water remaining inside the filter which was used to test the product during the inspection process at the factory. This does not mean that the product was previously used.



Caution

Cold main water supply

- ▶ Make sure that the bidet is connected to the cold water pipe.
(If the product is connected to the hot water pipe, this may damage the filter and hose).

1. Turn off the main water supply valve ① and separate the existing water tank hose ②.

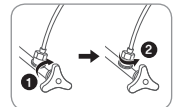

2. Connect the rubber packing, T-shaped connector, and water tank hose in this order to the existing water pipe. Please connect the bidet hose to the T-shaped connector.

- * Please ensure that the rubber packing is inserted between the water pipe and the T-shaped connector.
- * Firmly tighten the nuts below and on top of the T-shaped connector all the way to the end in a clockwise direction.

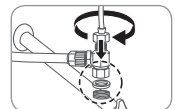



INSTALLING YOUR BIDET



Installing the product

3. Place the fixing slider over the installation plate on the toilet, insert the fixing bolts, and fasten the nuts so that the installation plate is fixed.

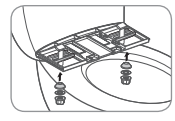

4. Align the back of the bidet to the installation plate and push the bidet backwards while pressing the button to the left of the bidet. (Hold the bidet with both hands and push it backwards until it clicks into place).

⚠ Check if the bidet moves to the left or right. If it moves, fasten the fixing nuts again.

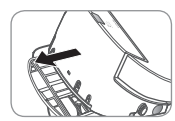

5. Connect the bidet hose to the side of the bidet.

Make sure that the bidet hose is firmly connected. If the main water supply valve is opened when the hose is not connected properly, the bidet hose may become separated and cause water to splash, resulting in injury.

⚠ Take care that the bidet hose is not excessively bent by twisting it.

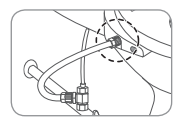

6. Open the main water supply valve.

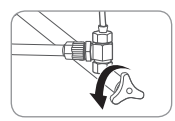

7. Connect the power cord to the electrical outlet.

- ▶ Make sure to use a grounded electrical outlet. In the case of a short circuit, grounding prevents electric shock or injury.
- ▶ Make sure to use a dedicated electrical outlet with grounding terminals.
- ▶ If using an extension cord is unavoidable, use one with grounding terminals for 120 V~ / 60 Hz or higher.



Caution

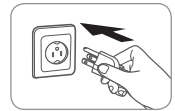



INSTALLING YOUR BIDET



Installing the remote control wall mount



- ▶ Make sure to install the remote control wall mount on the wall using the supplied screws. Failing to do so may result in the product falling and being damaged.
- ▶ If the bathroom has 3 sides in a black or similar color, use the remote control while fixing it to the wall holder.
- ▶ Failing to do so may result in the product not working properly due to the remote control signal reception ratio being too low.

1. Place the remote control wall mount over the required position on the wall and mark the 2 points for the anchors on the wall.

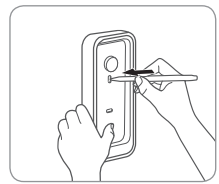

2. Drill 2 holes with a depth of approximately 35 mm at the marked points.
* Use a drill bit with a diameter of \varnothing 6.5 mm.

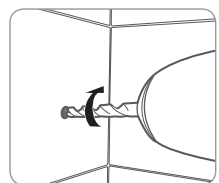

3. Insert the anchors into the holes and push them all the way in.

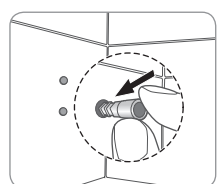

4. Remove the 2 pieces of protective film from the back of the remote control wall mount, and attach the mount to the wall aligning the holes with the anchors in the wall.

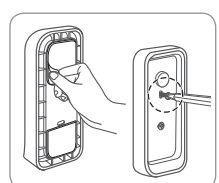

5. Place the remote control into the mount as shown by the figure.

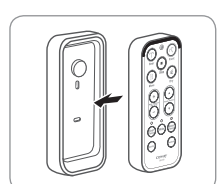



CLEANING AND MAINTAINING YOUR BIDET



Cleaning the nozzles



Tips

- ▶ If excessive force is exerted on the nozzles when cleaning them, the nozzles may no longer work properly or break. Hold the nozzles lightly when cleaning them.
- ▶ When cleaning the nozzles, Nozzle cleaning water is emitted. (However, when main water supply is not supplied (main water supply stop status), no nozzle cleaning water is emitted and only the nozzle is extended).

1. Press the 'Nozzle Cleaning' button on the operation part to the right of the bidet.

- Nozzle cleaning water is sprayed and the front nozzle is fully extended.
- Clean the front nozzle.

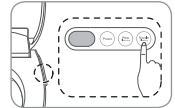

2. Press the 'Nozzle Cleaning' button on the operation part again.

- Nozzle cleaning water is sprayed, the front nozzle retracts itself, and rear nozzle is extended fully.
- Clean the rear nozzle.



3. If you press the 'Power' button or the 'Nozzle Cleaning' button on the operation part again after cleaning the nozzles, nozzle cleaning water is sprayed, and the rear nozzle retracts itself.

- If no button is pressed for 2 minutes after the nozzle cleaning starts, the nozzle retracts itself automatically.

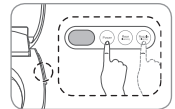

Cleaning the product body

■ Apply a neutral detergent to a soft cloth or sponge and clean the product.

- Failing to do so may result in deformation or product damage.

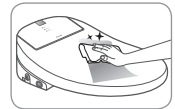

Tips



- Do not use thinner or benzene.
- Do not clean the product using a coarse scrub or abrasive detergent.





CLEANING AND MAINTAINING YOUR BIDET



Removing the product

1. Unplug the power cord from the electrical outlet.

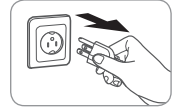

2. Close the main water supply valve.

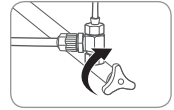

3. Pull the product forwards by holding both sides of the product while pressing the button at the bottom left of the product, to separate the product from the installation plate.



Tips

- Unplug the product if it will not be used for a long time.

4. Remove the drain plug at the back of the bidet by turning it counterclockwise by 90 degrees ① and then pulling it forwards ② so that the water in the hot water tank is drained into the toilet.

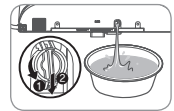

Cleaning the MESH filter

1. Separate the product from the installation plate.

- Refer to Removing the product (1~3).

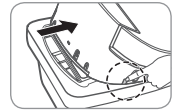

2. Remove the MESH filter at the bottom left of the product.

- Remove the MESH filter by turning it with a '+' screw driver.





CLEANING AND MAINTAINING YOUR BIDET



Cleaning the MESH filter

3. Clean the MESH filter by shaking it under flowing water.

- Removing foreign substances from the MESH filter with a toothbrush is more effective.
- Do not clean the MESH filter excessively, as it may damage the MESH.

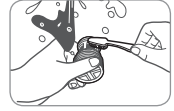

4. Reinstall the cleaned MESH filter into the product.

- Check that the MESH filter is installed correctly.
- If you open the main water supply valve when the MESH filter is not completely installed, water leakage may occur.



Tips

- ▶ When not using the product for a long period of time, clean the filter before using the product again.
- ▶ The filter cleaning interval may differ depending on the water quality.



SPECIFICATIONS

Product name		Coway Bidet
Model no.		BA13-AR/AE/BR/BE
Standard power voltage		240V~60Hz
Power consumption		1 200 W
Supply water pressure		0.11 MPa - 0.68 MPa
Dimensions	BA13-AR/BR	382 mm (Width) × 493 mm (Depth) × 144 mm (Height)
	BA13-AE/BE	382 mm (Width) × 528 mm (Depth) × 144 mm (Height)
Weight		6 kg - 6.5 kg
Warm water cleansing device	Rear cleansing	Maximum 0.5 L/min, automatic nozzle self-cleaning function
	Front cleansing	Maximum 0.5 L/min, automatic nozzle self-cleaning function
	Standard time	Rear cleansing 1 minute, front cleansing 1 minute, drying 2 minutes
	Water pressure control	3 levels Micom control
	Warm water temperature control	4 levels (Off : Room temperature, L : 31.5 °C, M : 34.5 °C, H : 37.5 °C)
	Power consumption by heater	1 250 W
Safety devices		Bimetal, temperature sensor, temperature fuse (overheating prevention), micro switch
Air dryer device	Warm air temperature control	4 levels (Off : Room temperature, L, M, H)
	Standard time	Drying for 2 minutes
	Power consumption by heater	180 W
	Safety devices	Bimetal, temperature fuse (overheating prevention)
Heated seat	Seat temperature control	4 levels (Off : Room temperature, L : 31 °C, M : 34 °C, H : 37 °C)
	Power consumption by heater	60 W
	Safety devices	Bimetal, temperature fuse (overheating prevention)
MESH filter	Specifications	25.2 mm (Length) × 19.8 mm (Ø)
Installation parts		T-shaped connector, Bidet hose, Installation plate, 2 fixing screws, 2 fixing rubbers, 2 fixing washers, 2 fixing nuts, 2 fixing sliders, 2 screws, 2 anchors, 3 batteries (AAA), Remote control wall mount
Other functions		Instant warm water system, AIR+water stream, MESH filter, Eco mode, Stainless steel twin nozzle (The Wide, Deodorization and Sterilization functions are supported for the BA13-BR/BE only)
Operating temperature		0 °C - 40 °C

* Manufacturer: Woongjin Cuchen Co., Ltd.

* The specifications are subject to change without prior notice for reasons of improving the product performance.

TROUBLESHOOTING

The bidet may operate abnormally due to minor causes not because of a product malfunction but because the user is unfamiliar with using the product. In such a case, problems can be easily solved even without the help of the Service Center by checking the following. If you cannot solve the problem after checking the following items, please call the Service Center.

PROBLEM	SOLUTION
The product is not working.	<ul style="list-style-type: none"> • Make sure the bidet is plugged in. • Check if there was a power failure. • Check if the remote control batteries are flat. Replace them if necessary.
No water is ejected.	<ul style="list-style-type: none"> • Make sure the water valve is opened. • Clean foreign material from the nozzle outlet holes using a toothbrush. • Make sure the water supply is running.
The water pressure is weak.	<ul style="list-style-type: none"> • Make sure that the water pressure is not too low. • Clean foreign material from the nozzle outlet hole using a toothbrush. • Remove, clean and then reinstall the filter (refer to p.21)
The seat or the water is not warm.	<ul style="list-style-type: none"> • Make sure that the seat and water temperature control buttons are set to the 'ON' status. Please adjust the setting to the correct temperature by pressing the seat temperature button or the water temperature button. • This bidet has a bimetal as one of safety device for water heater. The safety device may cycle 'OFF' if temperature exceeds over normal level. In the event of the safety device operation, the bidet do not work and show error message until the appliance cool down and then the bimetal will automatically reset. If the error message shows up, you can restart the bidet by pressing any button of remote control.
The air from the air dryer is cold.	<ul style="list-style-type: none"> • During the drying operation. Adjust the temperature by pressing the air dryer temperature control button.
Water leaks from areas other than the nozzles.	<ul style="list-style-type: none"> • If water is leaking from the T-shaped connector, make sure that the rubber packing is inserted into the T-shaped connector, and firmly tighten the nut again. • If water is leaking from the bidet hose connection, make sure that the bidet hose is connected completely. • If water is leaking from the filter, check if there is any foreign material between the filter and the product. • In this case, install the filter completely or reinstall the filter after cleaning it. Check whether the filter is damaged. If the filter is damaged, call our service center.
Water is emitted while the bidet is not in use.	<ul style="list-style-type: none"> • The water that comes out between the nozzles after cleansing is for cleaning the nozzles, and is not a malfunction. • In some cases, water remaining around the nozzles may drip into the toilet. This is not a malfunction.
The bidet does not work when the buttons on the operation part are pressed.	<ul style="list-style-type: none"> • If the seat sensor cannot detect that you are seated because you are too far away, functions do not work.



Tips

- ▶ When bidet eco mode is set, you may feel that the seat is relatively cold when taking a seat. If bidet eco mode is cancelled, the last set temperature is maintained.
- ▶ For cancelling bidet eco mode, see page 11.
- ▶ If the bidet or remote control is flooded, it may cause a malfunction or other problem.



**WARRANTY CARD OR WARRANTY LETTER
ONE YEAR LIMITED WARRANTY
BIDET BA13-AR/AE/BR/BE ('PRODUCT')**

Model:

Serial Number:

Customer Name:

Date of Purchase:

('OWNER')

What This Warranty Covers:

Commencing with the date of purchase of the Product and continuing for a period of one year, if manufacturing defects in the Product cause the Product to not operate properly for its intended use, then subject to the exclusions, conditions, and limitations contained herein, COWAY at its sole option will repair or replace the Product. Decisions as to the extent of repair or replacement required will be made solely by COWAY.

The remedy under this Warranty is available only for that portion of the Product exhibiting defects at the time of the warranty claim. The replacement Product as well as any remaining original Product will be warranted only for the original one year warranty period. This limited warranty applies only to Product used for an application specified by COWAY for the Product and applied in strict accordance with COWAY published specifications in effect at the time of application. IF PRODUCT IS USED FOR OTHER THAN ITS INTENDED PURPOSE, IT IS SOLD AS IS AND WITHOUT ANY EXPRESS OR IMPLIED WARRANTIES, INCLUDING OF MERCHANTABILITY OR FITNESS FOR A PARTICULAR PURPOSE.

What This Warranty Does Not Cover:

This Warranty warrants that the Product will be free from manufacturing defects which affect the ability of the Product to operate for its intended use; it is not a warranty that the Product will never require repairs or to undertake responsibilities, liabilities or obligations other than those specifically identified in the preceding section.

COWAY is not responsible or liable for personal injury or property damage of any kind, even if arising from a breach of this Warranty.

Limitations and Exclusions:

TO THE EXTENT PERMITTED BY APPLICABLE LAW, COWAY DISCLAIMS ANY OTHER WARRANTY EXPRESS OR IMPLIED, THAN THAT PROVIDED FOR HEREIN. THIS WARRANTY IS IN LIEU OF AND EXCLUDES ALL OTHER WARRANTIES, GUARANTEES, CONDITIONS AND REPRESENTATIONS, EXPRESS OR IMPLIED, ORAL OR WRITTEN, STATUTORY OR OTHERWISE, INCLUDING BUT NOT LIMITED TO ANY IMPLIED CONDITIONS OR WARRANTIES AS TO THE MERCHANTABILITY OR FITNESS FOR A PARTICULAR PURPOSE OF THE COWAY PRODUCT. SOME STATES DO NOT ALLOW LIMITATIONS ON HOW LONG AN IMPLIED WARRANTY LASTS, SO THE ABOVE LIMITATION MAY NOT APPLY TO YOU. COWAY DOES NOT AUTHORIZE ANY PERSON INCLUDING ITS REPRESENTATIVES, TO MAKE ANY REPRESENTATION OR TO OFFER ANY WARRANTY, CONDITION OR GUARANTY IN RESPECT OF THE PRODUCT OTHER THAN THIS WARRANTY. THIS LIMITED WARRANTY SHALL BE THE OWNER'S SOLE AND EXCLUSIVE REMEDY AGAINST COWAY AND COWAY SHALL NOT BE LIABLE FOR ANY CONSEQUENTIAL, EXEMPLARY, SPECIAL, INCIDENTAL OR OTHER DAMAGES INCLUDING, BUT NOT LIMITED TO, LOSS OF PROFITS, AND LOSS OF USE. INCIDENTAL, CONSEQUENTIAL AND EXEMPLARY DAMAGES SHALL NOT BE RECOVERABLE EVEN IF THE REMEDIES OR THE ACTIONS PROVIDED FOR IN THIS WARRANTY FAIL OF THEIR ESSENTIAL PURPOSE. SOME STATES DO NOT ALLOW THE EXCLUSION OR LIMITATION OF INCIDENTAL OR CONSEQUENTIAL DAMAGES, SO THE ABOVE LIMITATION OR EXCLUSION MAY NOT APPLY TO YOU. COWAY SHALL NOT BE LIABLE FOR ANY DAMAGES WHICH ARE BASED UPON NEGLIGENCE, BREACH OF WARRANTY, STRICT LIABILITY OR ANY OTHER LEGAL THEORY OF LIABILITY OTHER THAN THE EXCLUSIVE LIABILITY SET FORTH IN THIS WARRANTY.

Limitations on Implied Warranties:

Any implied warranty of merchantability or fitness for a particular purpose or use, shall be limited to the duration of the foregoing express written warranty.

Conditions of Warranty:

COWAY's continuing liability under this Warranty is conditioned upon the following:

- a) The defect or damage is not caused by or is the result of : abnormal use or conditions; improper storage, unauthorized modifications or repair; misuse, neglect, accident, alteration, improper installation or other acts that are not the fault of Coway or the manufacturer of the product or that are not covered by the manufacturer's warranty;
- b) The Product has not been altered, modified or repaired without prior written approval of COWAY;
- c) The OWNER has notified COWAY in writing of any failure of the Product covered by this Warranty within thirty (30) days following such failure;
- d) There has been no misuse, abuse or negligence with respect to the Product on the part of the OWNER.

Waiver:

COWAY's failure at any time to enforce or rely upon any of the terms or conditions stated herein shall not be construed to be a waiver of its rights hereunder.

Obtaining Warranty Service and OWNER'S Duties:

If the Product fails to operate for its intended purpose, then notify COWAY at (852)2334-5660, within 48 hours or within the next business day after discovery of any defect in the Product. The OWNER must give written notice to COWAY no later than thirty (30) days after a defect is discovered or should by reasonable diligence have been discovered. Claims under this Warranty will require proof of purchase by the OWNER.

COWAY is not responsible for any claims without such proof of purchase. Should the alleged failure or the remedy sought by the OWNER lie outside the scope of this Warranty, OWNER agrees to promptly reimburse COWAY for the cost of any investigation requested by OWNER, including remedy costs, plus a COWAY administrative fee.

We Bring Wellness
Coway



Made in Korea | www.coway.com
