

We Bring Wellness
Coway



Bidet
BA13-AR/AE/BR/BE



This document is technical property of Coway. Use of this document without Coway's prior approval or for purposes other than repair of products of the company may subject to legal claims.

Coway Co., Ltd.

Table of Contents

1. Precaution

1-1	Precautions on electricity	1-2
1-2	Precautions on installation	1-3
1-3	Precautions on services	1-4

2. Product characteristics and specifications

2-1	Product characteristics	2-1
2-1-1	BA13-A/B Common Functions	2-1
2-1-2	Additional functions for the BA13-BR/BE	2-2
2-2	Major specifications	2-3
2-3	Appearance and dimensions	2-4

3. Product installation

3-1	Installation materials	3-1
3-1-1	Parts	3-1
3-2	Installation method	3-3
3-2-1	Precautions on installation	3-3
3-2-2	Using the rear nozzle	3-3
3-2-3	Installing the tubing hose type	3-4
3-2-4	Installing the braid hose type	3-6
3-2-5	Installing the remote control mount	3-8
3-3	Checking the system after installation	3-10

4. Disassembling and refitting

4-1	Disassembling and refitting information	4-1
4-1-1	Disassembling and refitting information	4-1
4-1-2	Necessary tools	4-1
4-2	Overall disassembling and refitting of BA13-A/B	4-2
4-2-1	Disassembling the Top Cover / Body Frame	4-2
4-2-2	Disassembling the Seat Cover / Seat	4-4
4-2-3	Disassembling the Main / Power / SMPS PBA	4-6
4-2-4	Disassembling the Sterilization / Deodorization Assembly	4-8
4-2-5	Disassembling the Nozzle Assembly	4-10
4-2-6	Disassembling the Nozzle Assembly parts	4-11
4-2-7	Disassembling the Flow Volume Adjustment Valve Assembly / Air Pump	4-12
4-2-8	Disassembling the Air Dryer Assembly	4-13
4-2-9	Disassembling the Instant Hot Water Assembly	4-14
4-2-10	Disassembling the Instant Hot Water Assembly parts	4-15
4-2-11	Disassembling the Feed Water Valve Assembly	4-21
4-2-12	Disassembling the Side PBA-L	4-23
4-2-13	Disassembling the Fixer-Hook	4-23

5. Fault diagnosis

5-1	Diagnosing and repairing faults.....	5-1
5-2	Checking methods per error mode.....	5-4

6. Exploded view of the system and the list of service parts

6-1	Exploded view and parts list of BA13-AR/AE/BR/BE.....	6-1
6-2	Exploded view and parts list of Nozzle-Assy.....	6-3
6-3	Service parts list of BA13-AR/AE/BR/BE.....	6-5

7. Parts location diagrams



7-1	Electrical wiring diagram.....	7-1
7-2	PBA location diagram.....	7-2
7-2-1	MAIN PBA.....	7-2
7-2-2	POWER PBA.....	7-5
7-2-3	DECO_LED PBA.....	7-6
7-2-4	BUTTON PBA.....	7-7
7-2-5	IR PBA.....	7-8
7-2-6	REMOTE CONTROL PBA.....	7-9

8. Reference information

8-1	Names of each part.....	8-1
8-2	Functions and reference information.....	8-3
8-2-1	Explanation of indication and operation parts.....	8-3
8-2-2	Remote control explanation of indication and operation parts.....	8-5
8-2-3	Using the rear nozzle.....	8-8
8-2-4	Using the front nozzle.....	8-9
8-2-5	Function specifications.....	8-11
8-2-6	The Water Flow Volume for each Step of the Rear/Front Cleansing operations.....	8-35
8-2-7	Power Consumption (Electric charge under the full-loading condition).....	8-35
8-2-8	Resistance value and voltage per temperature sensor (T1, T2, Seat) temperature (10.74 k Ω / 25 °C / 2.5 V).....	8-36
8-3	After services.....	8-37
8-3-1	Cleaning the nozzles.....	8-37
8-3-2	Cleaning the product body.....	8-38
8-3-3	Removing the product.....	8-39
8-3-4	Cleaning the MESH filter.....	8-40

1. Precaution

1. The precautions are for consumers to use the product safely and correctly, and to prevent accidents or risks during product repairs. Please read the precautions carefully and comply with them.
2. Precautions are classified into Danger, Warning, and Caution with the meanings as follows:

	Danger	If not observed, serious injury or even death may occur as a result.
	Warning	If not observed, serious physical injury or property damage may occur as a result.
	Caution	If not observed, minor physical injury or property damage may occur as a result.

1-1 Precautions on electricity

- ▲ Do not use a damaged power cord or loose electric outlet.
 - Otherwise electric shock or fire may occur as a result.
- ▲ Do not pull the power cord or handle the power plug with a wet hand.
 - Otherwise short circuit, electric shock, or fire may occur as a result.
- ▲ Do not forcefully bend the power cord or run it under a heavy object to prevent it from being damaged or deformed.
 - Otherwise electric shock or fire may occur as a result.
- ▲ If the electrical outlet is wet, carefully unplug the unit and let the electric outlet completely dry before subsequent use.
 - Otherwise electric shock or fire may occur as a result.
- ▲ Unplug the product before repair, inspection, or parts replacement.
 - Otherwise electric shock may occur as a result.
- ▲ Do not plug into an electrical outlet or power strip that is being used by several other appliances. Use an electrical outlet dedicated to the product.
 - Otherwise fire may occur as a result.
- ▲ Do not attempt to repair or modify the power cord.
 - Otherwise electric shock or fire may occur as a result.
- ▲ Remove any dust or water off the power plug.
 - Otherwise electric shock or fire may occur as a result.
- ▲ Do not connect and pull out the power plug repeatedly.
 - Otherwise electric shock or fire may occur as a result.
- ▲ In the case the power cord is damaged, do not replace the cord yourself. Call Coway Service Center to have it replaced.
 - Otherwise electric shock or fire may occur as a result.

1-2 Precautions on installation

- ⚠ Do not install the product where the bidet is exposed to direct sunlight or heating devices.
 - Otherwise product deformation or fire may occur as a result.
- ⚠ Do not install the product in areas where moisture or water (rainwater) is present.
 - Otherwise electric shock or fire may occur as a result.
- ⚠ Do not use the product in areas where flammable gases or combustible materials are used or stored.
 - Otherwise fire may occur as a result.
- ⚠ Use tap water as supply water.
 - Industrial water or gray water, if used as supply water, may cause skin damage or diseases.
- ⚠ Do not connect the water inlet to the hot water supply pipe.
 - Otherwise product malfunctions or accidents may occur as a result. (Make sure to connect the water inlet to the cold water supply pipe.)
- ⚠ After installation, make sure to check water supply connections for leaks.
 - Rubber packing must be applied to the water hose connections.
- ⚠ When installing the bidet
 - Tighten the fixing bolts firmly so that the bidet body won't be shaky on the toilet.
- ⚠ Installing location
 - As the bidet should be installed on the toilet, take caution not to have water splashed on the bidet.
- ⚠ After the bidet is installed
 - Keep the removed existing toilet seat in a shaded place to prevent its damage.
- ⚠ Cold water piping
 - Make sure to connect the water inlet to the cold water supply pipe. (If the product is connected to hot water pipe, the filter and hose may be damaged.)

1-3 Precautions on services

■ Before the service

- ▲ Do not let consumers disassemble, repair, or modify the product.
 - Otherwise electric shock, fire, or product damage may occur as a result.
- ▲ To prevent the risk of electric shock, unplug the unit before checking and repairing the product.
 - Before checking or repairing the product, make sure to discharge the electrical unit of PBA. Otherwise, high-voltage electric shock may occur as a result.
- ▲ To remove the power cord from the electrical outlet, make sure to do it by pulling the power plug.
 - Otherwise the power cord may be damaged and electric shock or fire may occur as a result.
 - Do not pull out the power plug from the electric outlet with a wet hand.
- ▲ Do not have the power plug applied to a single electrical outlet to which several other electrical appliances are connected.
 - Otherwise fire may occur as a result of overheating.
- ▲ When cleaning the product, do not have water or detergent sprinkled on or applied directly to the product.
 - Otherwise electric shock, fire, or product damage may occur as a result.
- ▲ Do not have an electrical heater placed near the product or have flamed materials such as a lit cigarette disposed of in the toilet.
 - Otherwise fire or product deformation may occur as a result.
- ▲ Do have any containers with water, medicine, food, any metallic objects, or any flammable material placed or used on top of the product.
 - In the case foreign material gets inside the product, electric shock or fire may occur as a result.
- ▲ Do not have flammable sprays or materials (gasoline, thinner, alcohol, etc) used or stored near the product.
 - Otherwise fire or product deformation may occur as a result.

■ During the service

- ▲ During the service, check for damage, deformation, or deterioration of the power plug and the electrical outlet.
 - If any abnormality is found, repair or replace the power plug or electrical outlet to prevent electric shock or fire.
- ▲ When servicing the product, completely remove dust or foreign material from housing, connection, and connector parts.
 - It is to prevent fire caused by tracing or short circuit.
- ▲ Check electrical parts, harnesses or connectors for any trace of moisture.
 - When moisture exists, replace the parts or completely remove the moisture.
- ▲ When fitting connectors to PBA terminals, make sure to push the connectors through until you hear the 'click' sound.
 - If connectors are loosely fitted, a product malfunction or fire may occur as a result.
- ▲ If a harness or connector terminal is damaged (cut), do not repair but replace it.
 - If it is repaired using materials such as insulating tapes, product malfunction or fire may occur as a result.

■ After the service

- ▲ After servicing the product, check the overall assembly status and terminal connection of terminals.
 - If electrical wiring is under pressure or parts are fitted incorrectly, re-assemble the product.
- ▲ Exercise caution not to have internal electrical wiring touches moving parts or sharp objects.
 - Otherwise, product malfunction, short circuit, or fire may occur as a result.
- ▲ After checking the product, tighten the fixing bolts firmly so that the product body is not shaky on the toilet.
 - If the product body is shaky on the toilet or installed out of balance, users may fall down from the toilet, resulting in injury.
- ▲ After servicing the product, make sure to check connections such as supply water valve, water supply hose, or T-shaped valve for leaks.
 - Otherwise electrical shock or injury may occur as a result.
- ▲ Make sure to use a grounded electrical outlet. In the case of short circuit, grounding prevents electric shock or injury.
 - Make sure to connect the power plug to a dedicated electrical outlet with grounding terminals. If an extension cord should be used, make sure to use one with grounding terminals for power rating AC 250V 7A or higher.
- ▲ Connect the electricity and check that the unit operates properly before letting consumers use the product.
 - Make sure to inform the consumer of the malfunction and repair details.

MEMO

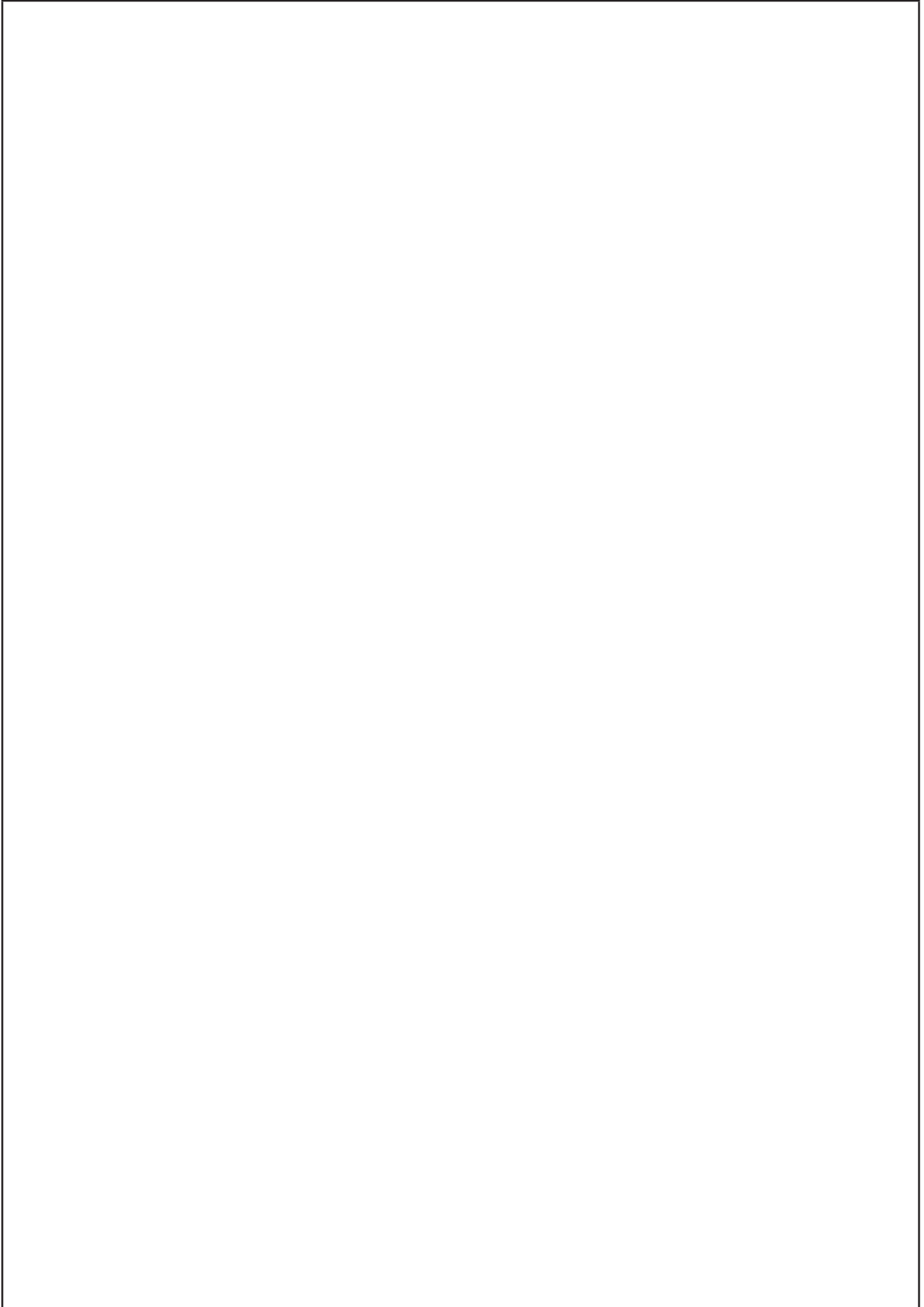

2. Product characteristics and specifications

2-1 Product characteristics

2-1-1 BA13-A/B Common Functions

■ Instant warm water system

- The water is instantly heated when using the rear and front cleaning functions so that you can immediately use water at your desired temperature.

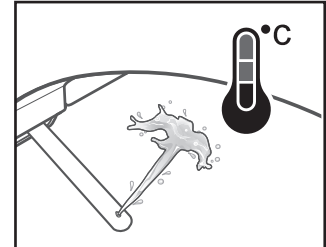

■ Air+ function

- The water stream with air bubbles provides softer, stronger cleansing.

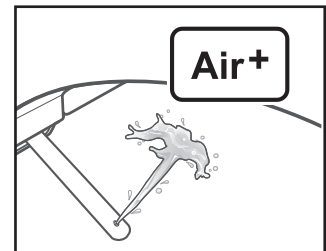

■ MESH FILTER

- The MESH filter is a semi-permanent item. You can use the filter repeatedly by cleaning it.

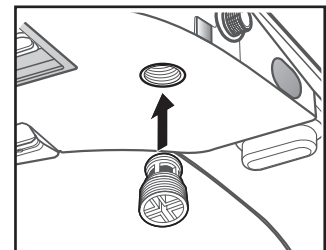

■ Eco mode

- Bidet eco mode: If the seat sensor does not detect someone sitting down or no panel or remote control button is pressed for approximately 10 minutes, the seat temperature is set to '1', so that power consumption is reduced. when bidet eco mode is activated, the eco mode indicator on the front is turned on.
- Remote control eco mode: If no remote control button is pressed for approximately 5 seconds, the remote control display is turned off to reduce the power consumption of the remote control battery.

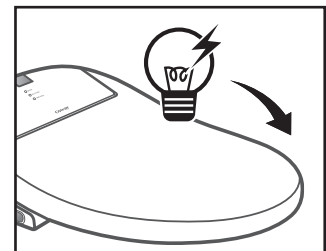

■ Stainless steel twin nozzle adopted for enhanced hygiene

- By adopting stainless steel nozzles, you can use the product more hygienically. In addition, the separation of the cleansing nozzle and the bidet nozzle ensures extra hygiene.

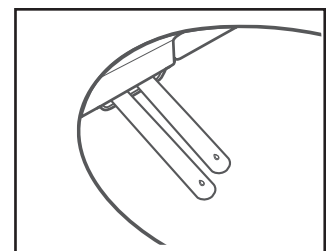

■ Wide Water stream

- A widely spread water stream applied to the cleaning water for smoother cleaning.

2-1-2 Additional functions for the BA13-BR/BE

■ Wide function

- You can directly select the degree of spread of the cleansing water from a strong flow of water to a soft, spread-out water flow when using rear and front cleansing.

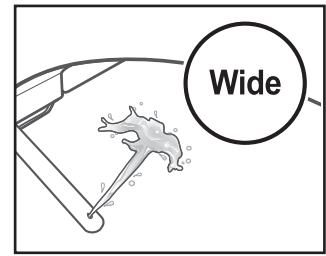

■ Deodorization function

- Once the seat sensor detects a person sitting, the deodorization function automatically deodorizes odors ensuring a refreshed feeling.

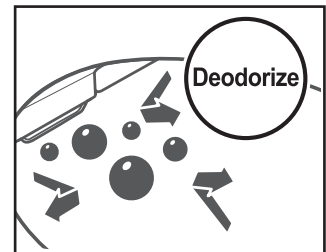

■ Sterilization function using oxidized silver

- This bidet sterilizes the nozzle with oxidized silver sterilizing water.

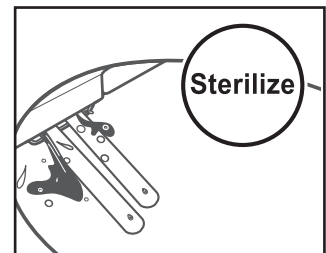

2-2 Major specifications

■ Basic specifications

Model no.		BA13-AR/AE/BR/BE
Standard power voltage		120 V~ 60 Hz
Power consumption		1,200 W
Supply water pressure		0.11 MPa - 0.68 MPa
Dimensions	BA13-AR/BR	382 mm (Width) x 493 mm (Depth) x 144 mm (Height)
	BA13-AE/BE	382 mm (Width) x 528 mm (Depth) x 144 mm (Height)
Weight		6 kg ~ 6.5 kg
Warm water cleansing device	Rear cleansing	Maximum 0.5 L/min, automatic nozzle self-cleaning function
	Front cleansing	Maximum 0.5 L/min, automatic nozzle self-cleaning function
	Standard time	Rear cleansing 1 minutes, front cleansing 1 minutes, drying 2 minutes
	Water pressure control	3 levels Micom control
	Warm water temperature control	4 levels (Off: Main water supply temperature, L: 31.5 °C, M: 34.5 °C, H: 37.5 °C)
	Power consumption by heater	1,250 W
	Safety devices	Bimetal, temperature sensor, temperature fuse (overheating prevention), micro switch
Air dryer device	Warm air temperature control	4 levels (Off: Room temperature, L, M, H)
	Standard time	Drying for 2 minutes
	Power consumption by heater	180 W
	Safety devices	Bimetal, temperature fuse (overheating prevention)
Heated seat	Seat temperature control	4 levels (Off: Room temperature, L: 31 °C, M: 34 °C, H: 37 °C)
	Power consumption by heater	60 W
	Safety devices	Bimetal, temperature fuse (overheating prevention)
MESH filter	Specifications	25.2 mm (Length) x 19.8 mm (Ø)
Installation parts		T-shaped connector, bidet hose, fixing plate 2 fixing screws, 2 fixing rubbers, 2 fixing washers, 2 fixing nuts, 2 fixing sliders, 2 screws, 2 anchors, 3 batteries (AAA), Remote control mount
Other functions		Instant warm water system, AIR+water stream, MESH filter, Power-saving function, Stainless nozzle (The Wide, Deodorization and Sterilization functions are supported for the BA13-BR/BE only)
Operating temperature		0 °C ~ 40 °C

※ The specifications are subject to change without prior notice for reasons of improving the product performance.

2-3 Appearance and dimensions

■ BA13-AR/BR [382 mm (Width) × 493 mm (Depth) × 144 mm (Height)]



▶ BA13-AR/BR (Round shape)

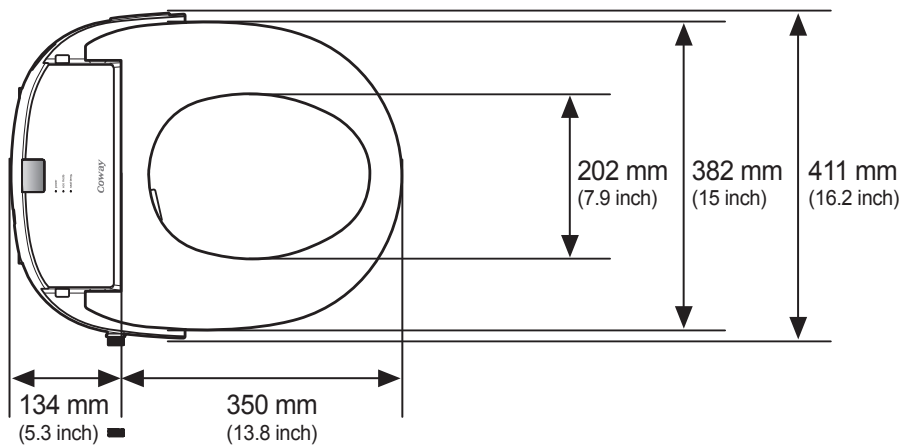

▶ Bottom view

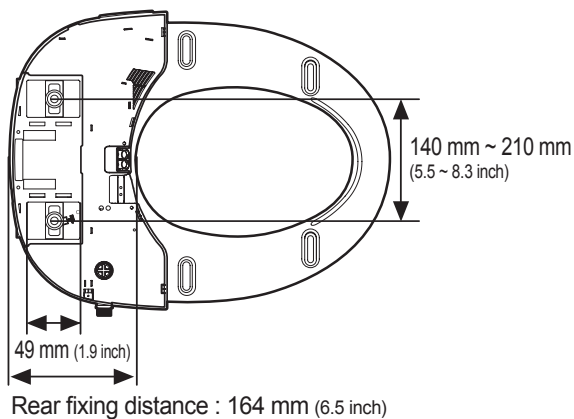

▶ Distance between fixing holes

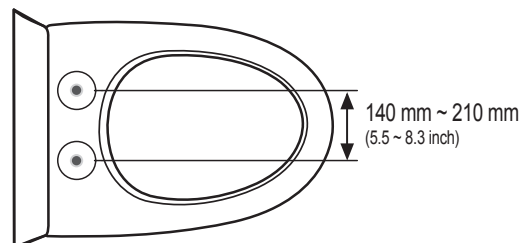

■ BA13-AE/BE [382 mm (Width) × 528 mm (Depth) × 144 mm (Height)]



▶ BA13-AE/BE (Elongated shape)

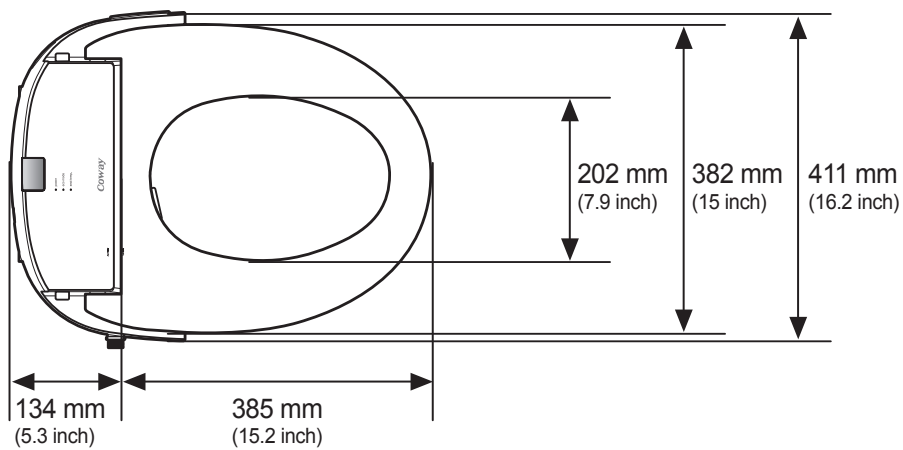

▶ Bottom view

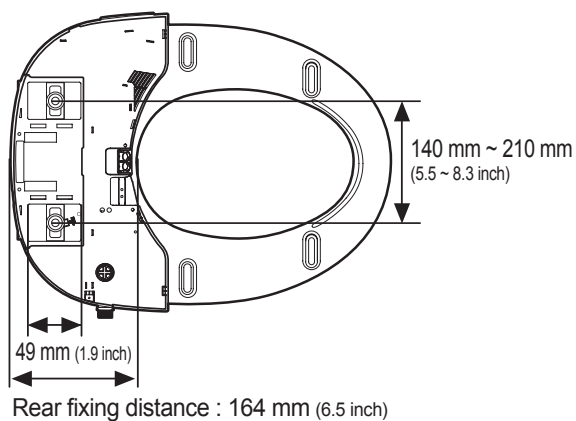

▶ Distance between fixing holes

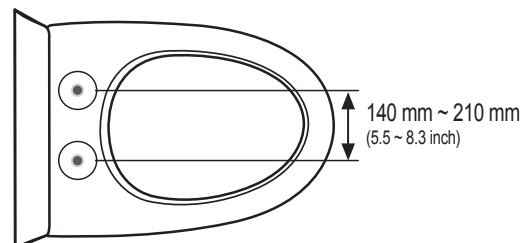



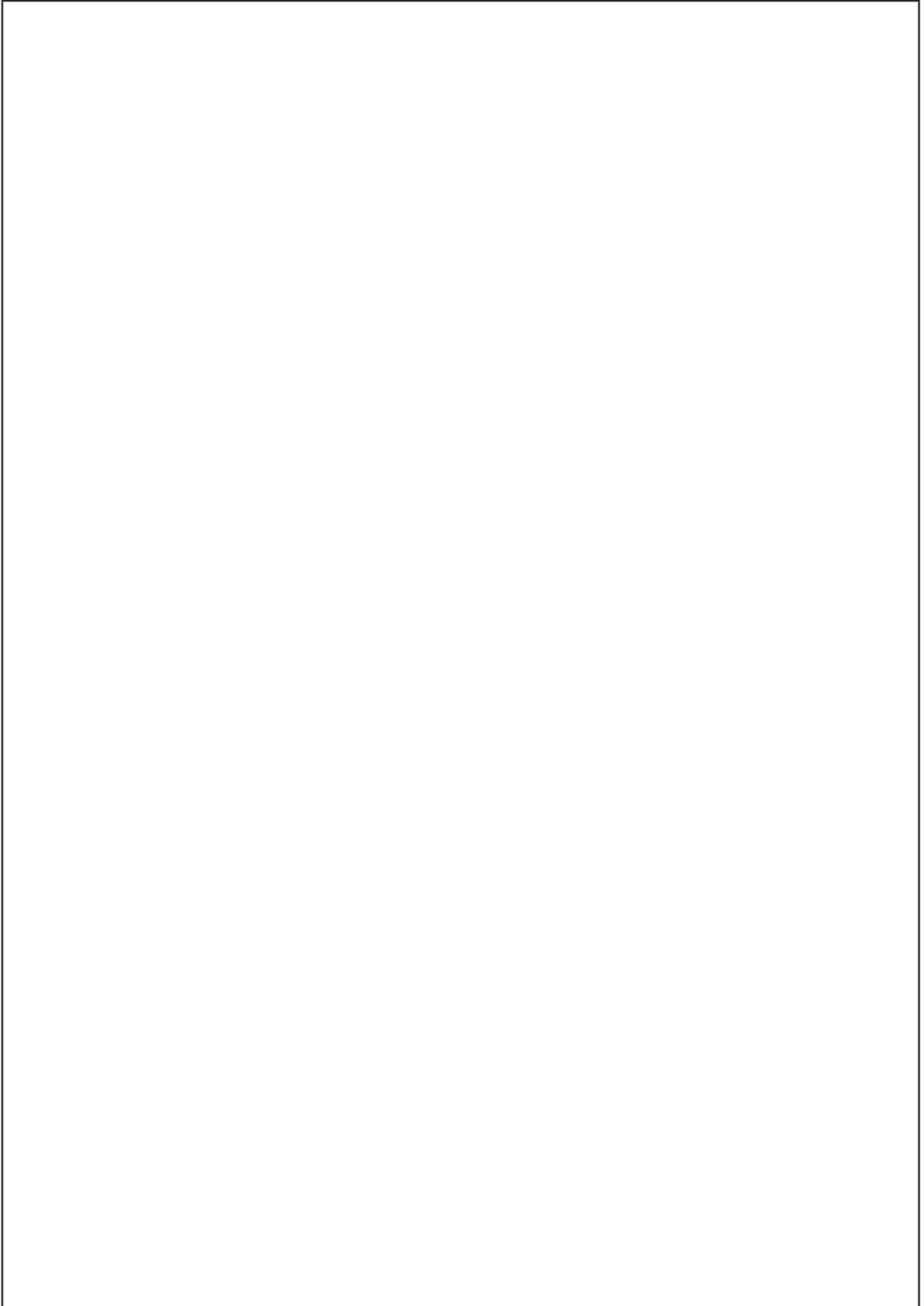





MEMO

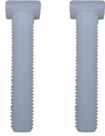







3. Product installation

3-1 Installation materials

3-1-1 Parts

No.	Accessories	Item	Remark
1		2 fixing screws	
2		2 fixing rubbers	
3		2 fixing washers	
4		2 fixing nuts	
5		Fixing plate	
6		2 fixing sliders	
7		T-shaped connector (for the tubing hose)	
8		Rubber packing	
9		Tubing hose	

No.	Accessories	Item	Remark
10		T-shaped connector (for the braid hose)	
11		Braid hose	
12		Remote control mount (including the sticker for attachment)	
13		2 screws	
14		2 anchors	
15		3 batteries (AAA)	

3-2 Installation method

3-2-1 Precautions on installation

■ When installing the bidet

Tighten the fixing bolts firmly so that the bidet body won't be shaky on the toilet.

■ Installing location

As the bidet should be installed on the toilet, take caution not to have water splashed on the bidet.

■ After the bidet is installed

Keep the removed existing toilet seat in a shaded place to prevent its damage.

■ Cold tap water

Make sure to connect the bidet to cold water. (If the product is connected to hot water, the filter and hoses of the bidet may be damaged.)

3-2-2 Using the rear nozzle

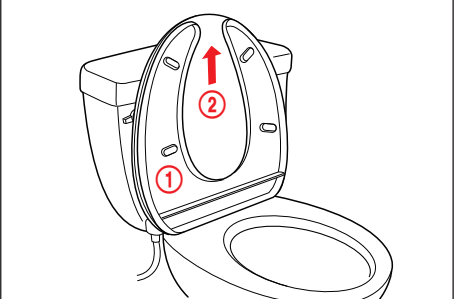
No.	Explanation	Reference picture
1	1) Remove the existing toilet seat ① and seat cover ② by removing the fixing nuts. ※ Keep the removed toilet seat in a shaded location to prevent it from being damaged.	

3-2-3 Installing the tubing hose type



Cold main water supply

- Make sure that the bidet is connected to the cold water pipe.
(If the product is connected to the hot water pipe, this may damage the filter and hose).

No.	Explanation	Reference picture
1	1) Turn off the main water supply valve ① and disconnect the existing water tank hose ②.	
2	1) Connect the rubber packing, the T-shaped connector (for the tubing hose), and the water tank hose in this order to the existing water pipe. Connect the tubing hose to the T-shaped connector (for the tubing hose). ※ Please ensure that the rubber packing is inserted between the water pipe and the T-shaped connector (for the tubing hose). ※ Firmly tighten the nuts below and on top of the T-shaped connector (for the tubing hose) all the way in a clockwise direction.	
3	1) Place the fixing slider over the fixing plate on the toilet, insert the fixing bolt, and fasten the nut so that the fixing plate is fixed.	
4	1) Align the back of the bidet with the fixing plate and push the bidet backwards while pressing the button to the left of the bidet. (Hold the bidet with both hands and push it backwards until it clicks into place.) ⚠ Check if the bidet moves to the left or right. If it moves, fasten the fixing nuts again.	

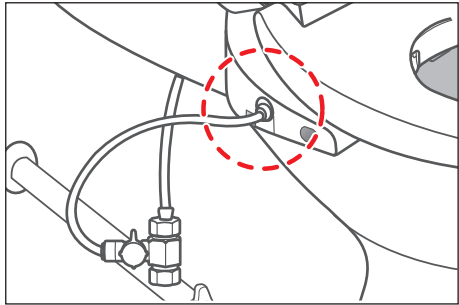
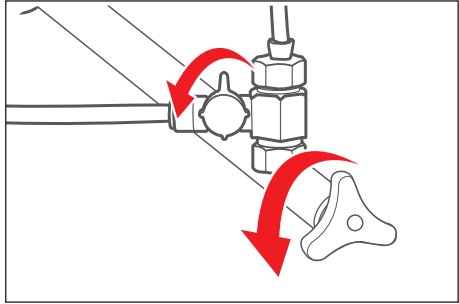
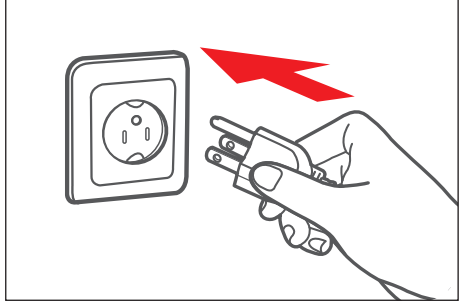
No.	Explanation	Reference picture
5	<p>1) Connect the tubing hose to the side of the bidet. Make sure that the tubing hose is firmly connected. If the water supply valve is opened when the hose is not connected properly, the tubing hose may become separated and cause water to splash out, resulting in injury.</p>	
6	<p>1) Open the two water valves.</p>	
7	<p>1) Connect the power cord to the electrical outlet.</p> <ul style="list-style-type: none"> ⚠ Make sure to use a grounded electrical outlet. In the case of a short circuit, grounding prevents electric shock or injury. ⚠ Make sure to use a dedicated electrical outlet with grounding terminals. ⚠ If using an extension cord is unavoidable, use one with grounding terminals for 120 V, 16 A or higher. 	

3-2-4 Installing the braid hose type



Cold main water supply

- Make sure that the bidet is connected to the cold water pipe.
(If the product is connected to the hot water pipe, this may damage the filter and hose).

No.	Explanation	Reference picture
1	1) Turn off the main water supply valve ① and separate the existing water tank hose ②.	
2	1) Connect the rubber packing, T-shaped connector (for the braid hose), and water tank hose in this order to the existing water pipe. Please connect the braid hose to the T-shaped connector (for the braid hose). ※ Please ensure that the rubber packing is inserted between the water pipe and the T-shaped connector (for the braid hose). ※ Firmly tighten the nuts below and on top of the T-shaped connector (for the braid hose) all the way to the end in a clockwise direction.	
3	1) Place the fixing slider over the fixing plate on the toilet, insert the fixing bolts, and fasten the nuts so that the fixing plate is fixed.	
4	1) Align the back of the bidet to the fixing plate and push the bidet backwards while pressing the button to the left of the bidet. (Hold the bidet with both hands and push it backwards until it clicks into place). ⚠ Check if the bidet moves to the left or right. If it moves, fasten the fixing nuts again.	

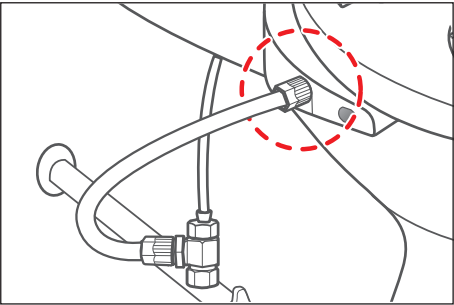
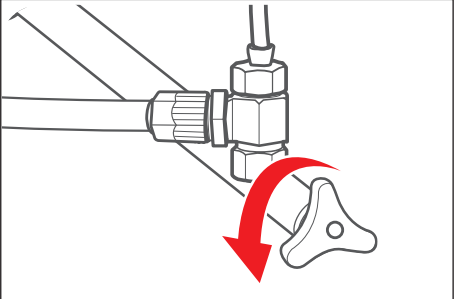
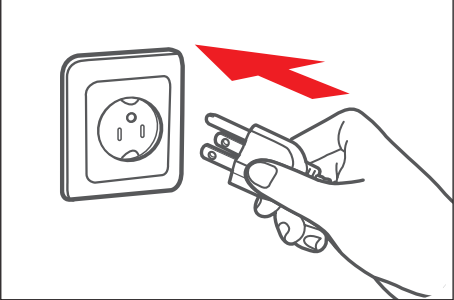
No.	Explanation	Reference picture
5	<p>1) Connect the braid hose to the side of the bidet. make sure that the braid hose is firmly connected. if the main water supply valve is opened when the hose is not connected properly, the braid hose may become separated and cause water to splash, resulting in injury.</p> <p>⚠ Take care that the braid hose is not excessively bent by twisting it.</p>	
6	<p>1) Open the main water supply valve.</p>	
7	<p>1) Connect the power cord to the electrical outlet.</p> <p>⚠ Make sure to use a grounded electrical outlet.</p> <p>⚠ In the case of a short circuit, grounding prevents electric shock or injury.</p> <p>⚠ Make sure to use a dedicated electrical outlet with grounding terminals. If using an extension cord is unavoidable, use one with grounding terminals for 120 V, 16 A or higher.</p>	

3-2-5 Installing the remote control mount

- ※ Make sure to install the remote control mount on the wall using the supplied screws.
Failing to do so may result in the product falling and being damaged.
- ※ If the bathroom has 3 sides in a black or similar color, use the remote control while fixing it to the wall holder.
- ※ Failing to do so may result in the product not working properly due to the remote control signal reception ratio being too low.

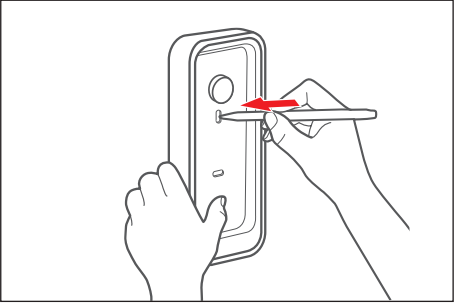
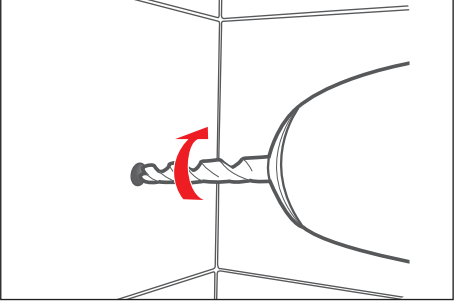
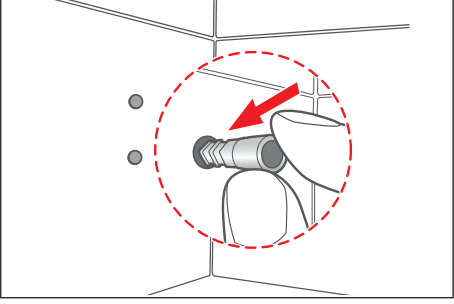
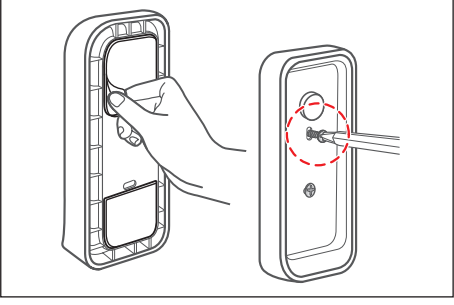
No.	Explanation	Reference picture
1	1) Place the remote control mount over the required position on the wall and mark the 2 points for the anchors on the wall.	
2	1) Drill 2 holes with a depth of approximately 35 mm at the marked points. ※ Use a drill bit with a diameter of Ø 6.5 mm.	
3	1) Insert the anchors into the holes and push them all the way in.	
4	1) Remove the 2 pieces of protective film from the back of the remote control mount, and attach the mount to the wall aligning the holes with the anchors in the wall.	

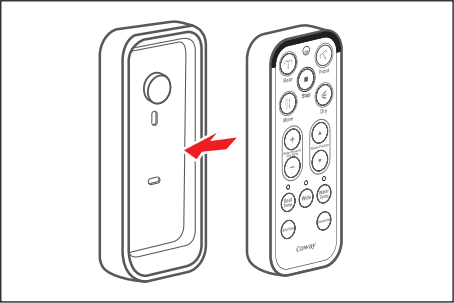
No.	Explanation	Reference picture
5	1) Place the remote control into the mount as shown by the figure.	 A technical line drawing illustrating the insertion of a remote control into a protective mount. On the left is the empty mount, which has a circular cutout at the top and a small rectangular slot below it. On the right is the remote control, which has a similar shape and a circular button at the top. A red arrow points from the remote control towards the mount, indicating the direction of insertion.

3-3 Checking the system after installation

- ※ After installing the bidet body on the toilet, check the following in a sequence before using the system.
- ※ Do not connect the power plug to the electrical outlet until the installation is complete.

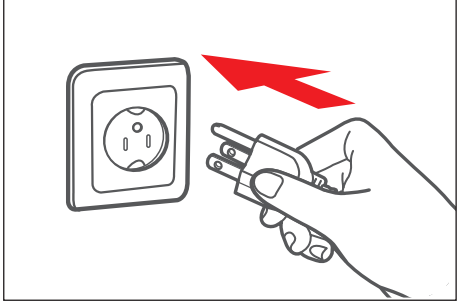
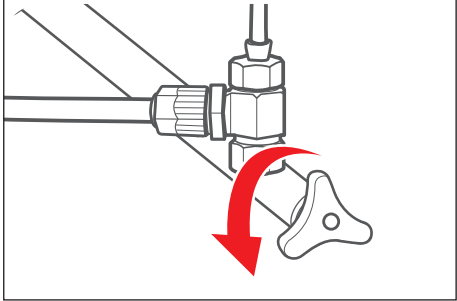
No.	Explanation	Reference picture
1	<p>1) Connect the power. Plug the power cord into the wall outlet. the bidet only works normally when the electricity is connected.</p> <p>※ This product is for 120 V~ / 60 Hz only. Make sure to connect the power plug to a grounded electric outlet (120 V~ / 60 Hz) dedicated to the product.</p>	
2	<p>1) Open the main water supply valve. The bidet only works normally when water is supplied.</p>	

4. Disassembling and refitting

4-1 Disassembling and refitting information

4-1-1 Disassembling and refitting information

■ Before disassembling the product





- Block the main water by closing the main water supply valve.
- Completely drain the water from the water tank.
If the water is splashed during the repair, insulation may deteriorate, resulting in danger.
- Please unplug.
- When disassembling and refitting the unit with its side touching the ground, perform the job on a working cloth. Without the working cloth, the product may get scratches.

■ Safety checking after the service

- Check that screws, parts, and wiring are in their original positions.
- Check that the wire coverings are not damaged.
- After refitting, check that the water purification works.
- Check the tubing for water leaks.
- Check that all switches operate normally.
- After the service, refit the product in its original state.



- ※ Exercise caution not to damage or deform any parts when disassembling the system.
- ※ Refit the system in the reverse order of disassembling.

4-1-2 Necessary tools

Tool	Tool name
	'+' Cross-head screwdriver
	'-' Flat-bladed screwdriver
	Nipper
	Adjustable spanner

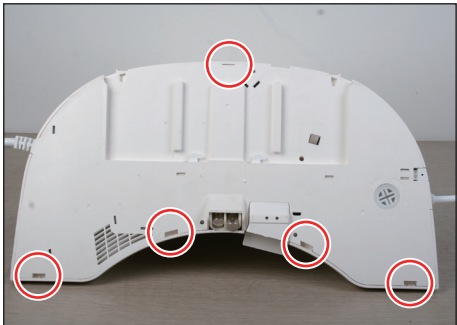

4-2 Overall disassembling and refitting of BA13-A/B

4-2-1 Disassembling the Top Cover / Body Frame

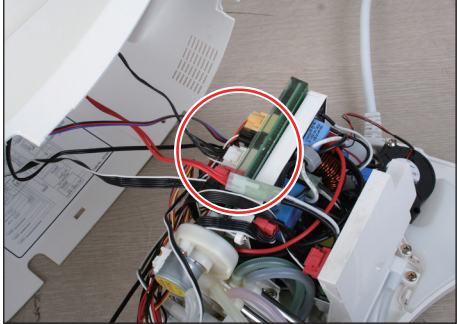
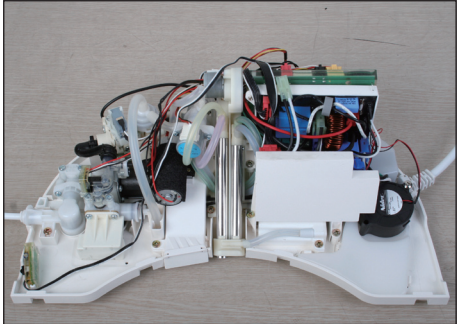
No.	Part name	Explanation	Reference picture
1	Top cover	<p>1) Remove the two screws from the back of the top cover. : 2-M4x12</p> <p>2) Unlock the 5 hooks at the bottom of the body frame using a “-” screwdriver.</p>	   

No.	Part name	Explanation	Reference picture
2	Body frame	<p>1) Separate all the connectors connected to the top cover.</p> <p>2) The top cover and body frame are completely separated.</p>	 

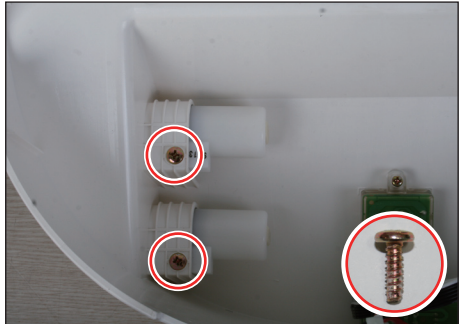
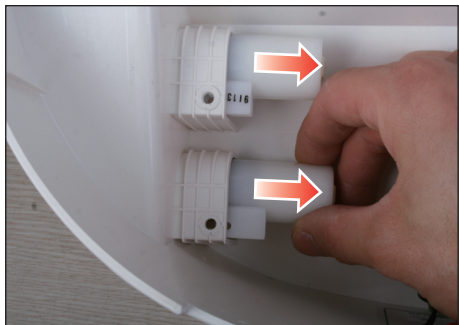
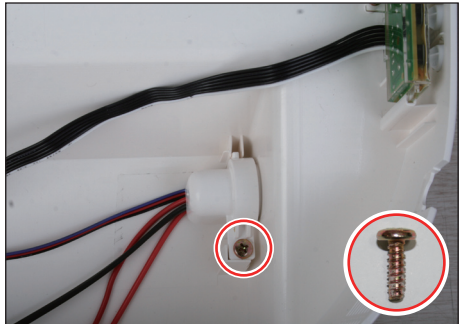
4-2-2 Disassembling the Seat Cover / Seat

No.	Part name	Explanation	Reference picture
1	Seat cover	1) Separate the seat cover by pulling it in the direction of the arrow as shown in the figure.	
2	Damper	1) Remove the screw fixing the damper from the inside left of the top cover. : 2-M4x12 2) Separate the damper by removing it in the direction of the arrow as shown in the figure.	 
3	Cover wire guide	1) Remove the screw from the cover wire guide. : M4x12 2) Separate the cover wire guide by turning it in the direction of the arrow.	 

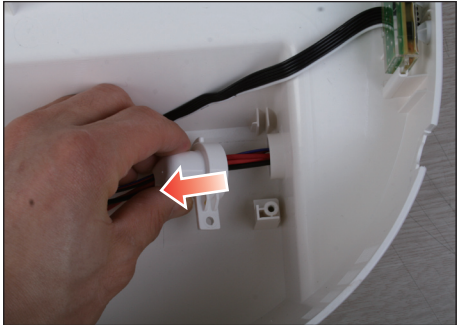
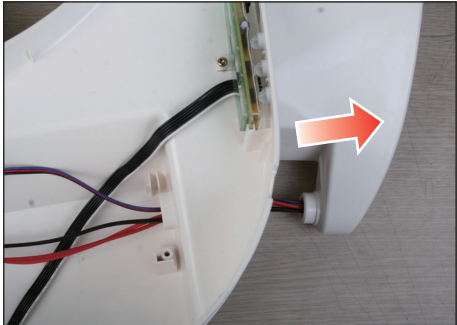
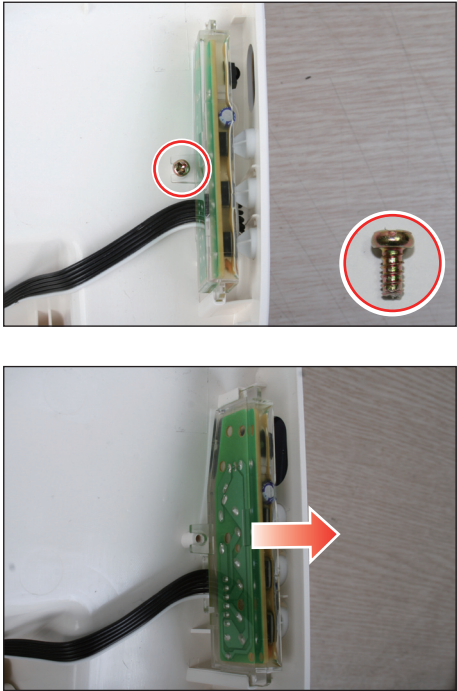
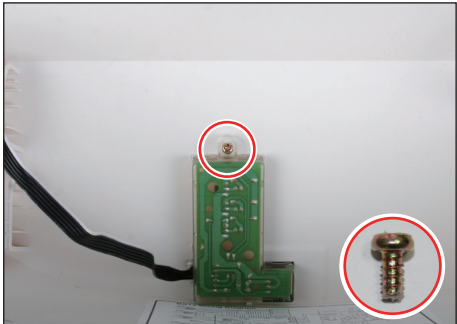
No.	Part name	Explanation	Reference picture
3	Cover wire guide		
4	Seat	<p>1) Separate the seat by removing it in the direction of the arrow as shown in the figure.</p>	
5	Side PBA-R	<p>1) Remove the screw from the Side PBA-R. : M3x8</p> <p>2) Separate the Side PBA-R by removing it in the direction of the arrow as shown in the figure.</p>	
6	LED-PBA	<p>1) Remove the single (1) screw and separate the LED-PBA. : M3x8</p>	

4-2-3 Disassembling the Main / Power / SMPS PBA

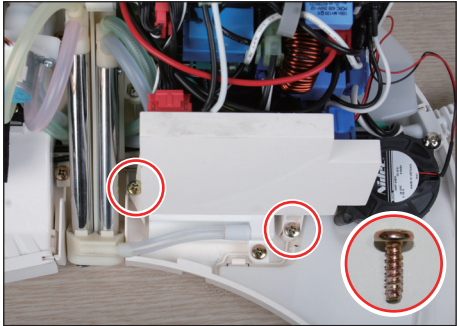
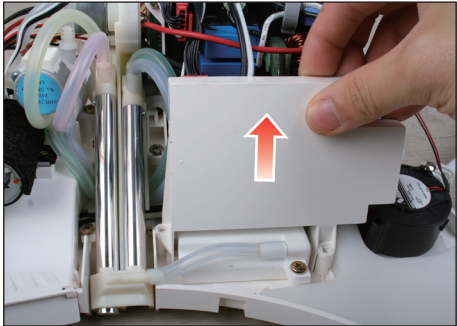
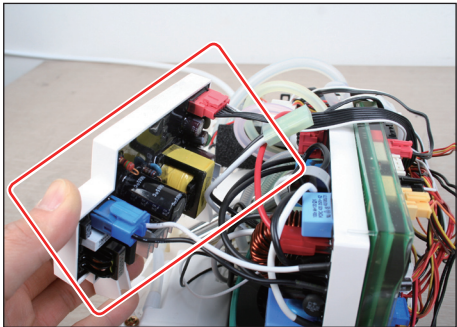
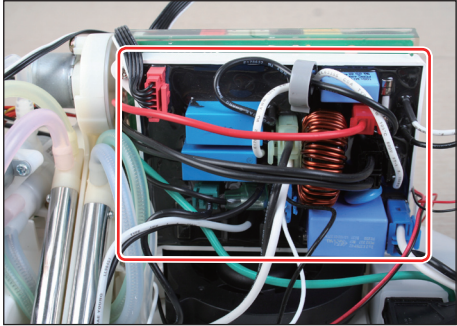
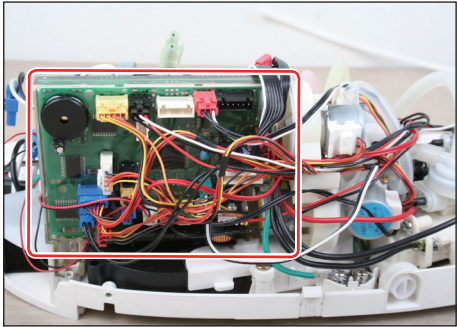

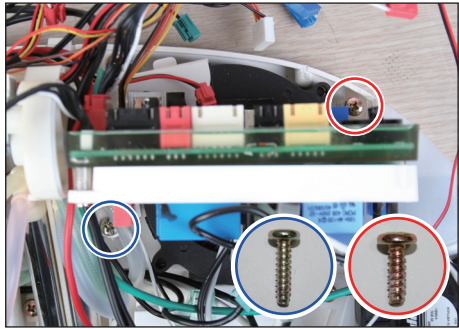
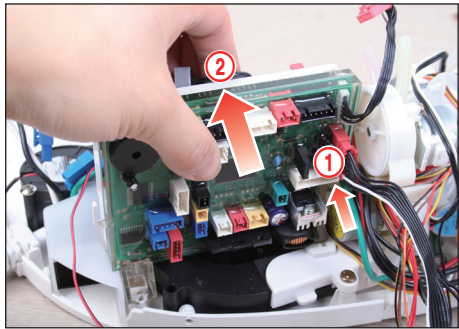
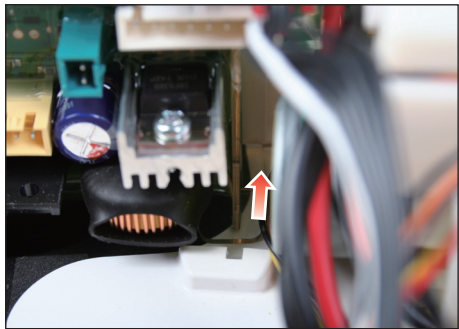
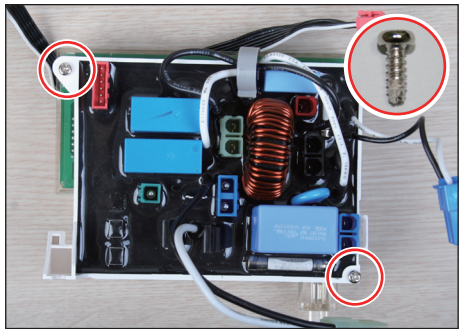

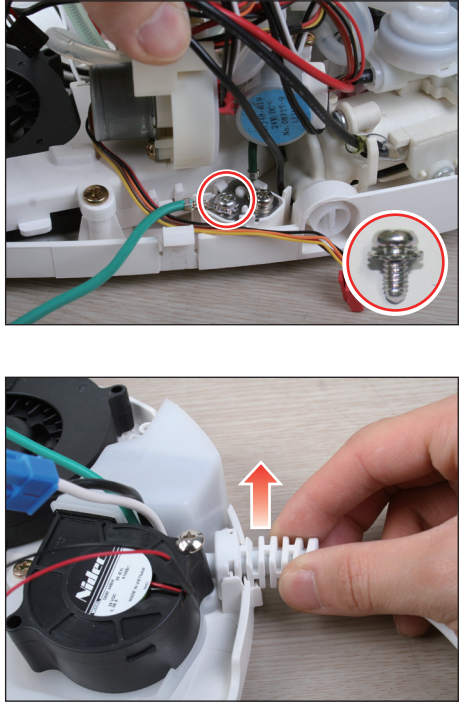
No.	Part name	Explanation	Reference picture
1	SMPS PBA	<p>1) Remove the 2 screws from the SMPS PBA. : 2-M4x12</p> <p>2) Lift the SMPS PBA up in the direction of the arrow.</p> <p>3) Remove all the connected connectors and separate the SMPS PBA completely.</p>	  
2	Power PBA / Main PBA	<p>1) Separate all connectors connected to the Power PBA.</p> <p>2) Separate all connectors connected to the Main PBA.</p>	 

No.	Part name	Explanation	Reference picture
2	Power PBA / Main PBA	<p>3) Remove the 2 screws from the Power PBA / Main PBA. : M4x12 - ○ : M4x16 - ○</p> <p>4) Separate the Power PBA / Main PBA in the direction of the arrow as shown in the figure.</p> <p>5) Remove the 2 screws connecting the Power PBA / Main PBA. : 2-3x10</p>	   

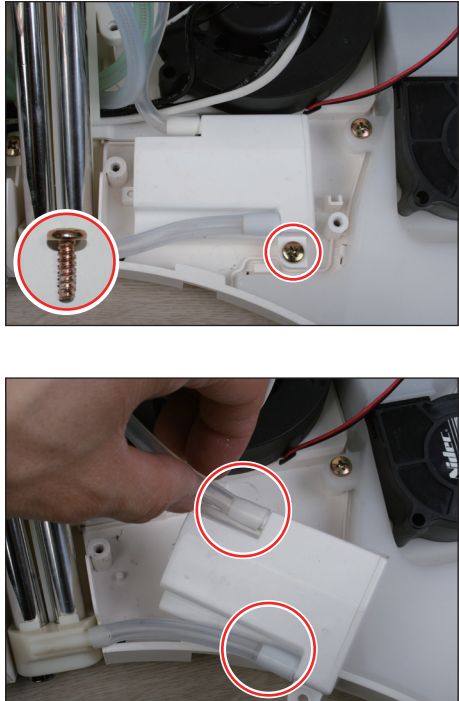
No.	Part name	Explanation	Reference picture
3	Power cord	<p>1) Separate the ground wire of the power cord. : M4x8 with external washer</p> <p>2) Separate the power cord by removing it in the direction of the arrow as shown in the figure.</p>	

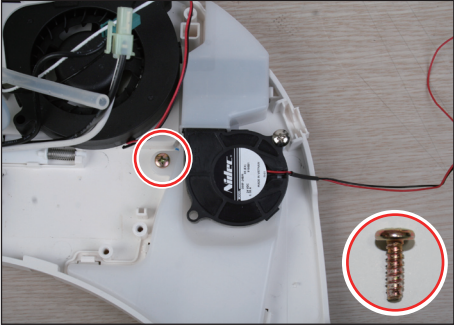
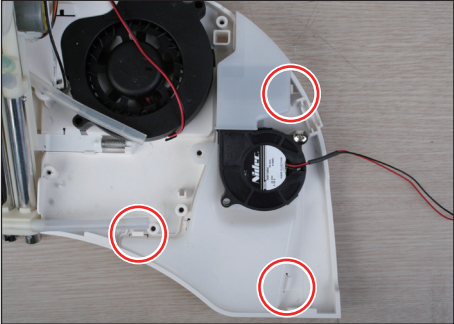
4-2-4 Disassembling the Sterilization / Deodorization Assembly

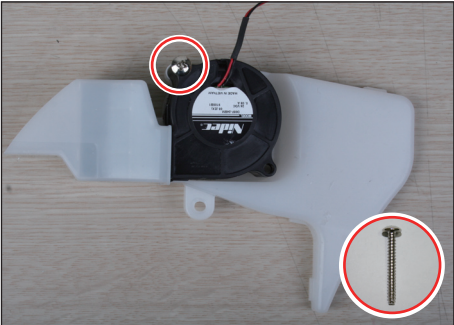
No.	Part name	Explanation	Reference picture
1	Sterilization Assembly	<p>1) Remove the screw from the Sterilization Assembly. : M4x12</p> <p>2) Separate the hose connected to the Sterilization Assembly.</p>	

No.	Part name	Explanation	Reference picture
2	Deodorization Assembly	<p>1) Remove the screw from the Deodorization Assembly. : M4x12</p> <p>2) Unlock the 3 fixing hooks and separate the Deodorization Assembly.</p> <p>3) Remove the screw from the Deodorization Assembly. : M4x32</p> <p>4) Separate the deodorization fan by removing it in the direction of the arrow as shown in the figure.</p>	    

4-2-5 Disassembling the Nozzle Assembly

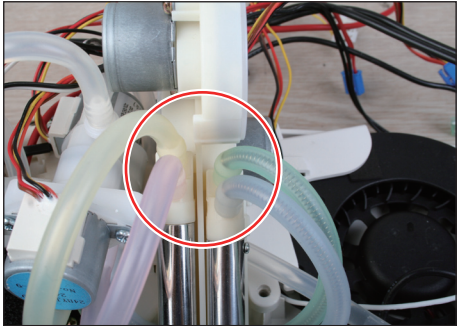
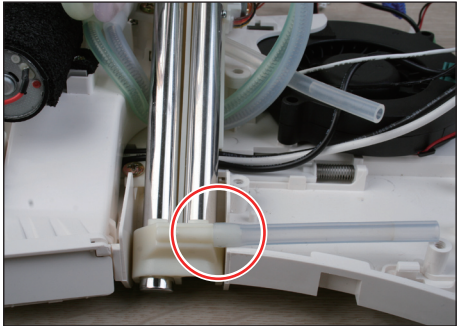
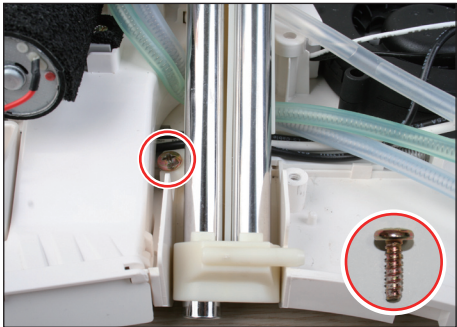
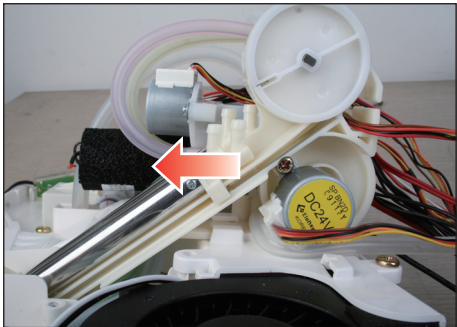
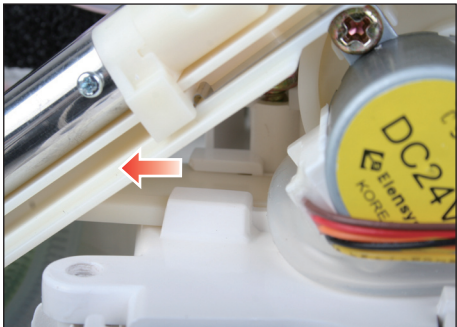
No.	Part name	Explanation	Reference picture
1	Disassembling the Nozzle Assembly	<p>1) Remove the 4 silicon hoses connected to the nozzle cylinder (front / rear cleansing).</p> <p>2) Separate the self-cleansing silicon hose.</p> <p>3) Remove the screw fixing the Nozzle Assembly. : M4x12</p> <p>4) Separate the Nozzle Assembly by pulling it in the direction of the arrow as shown in the figure.</p>	    

4-2-6 Disassembling the Nozzle Assembly parts

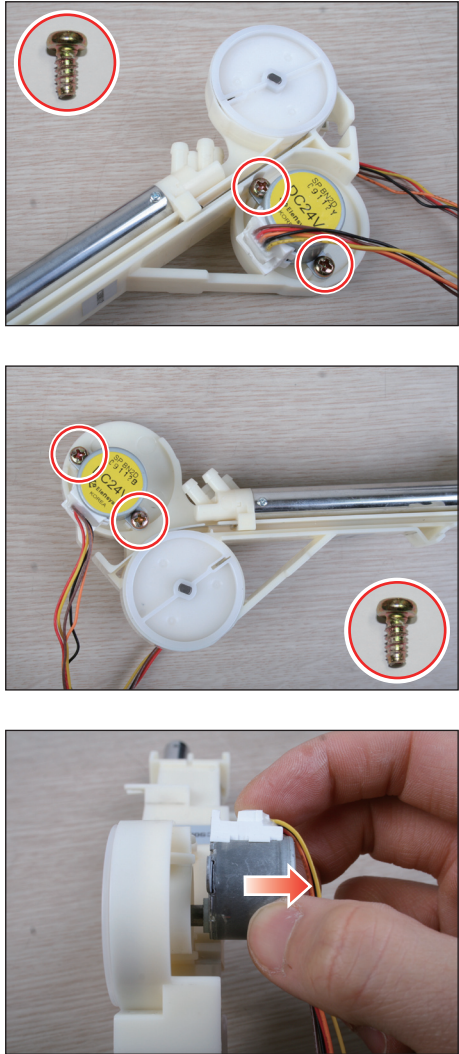
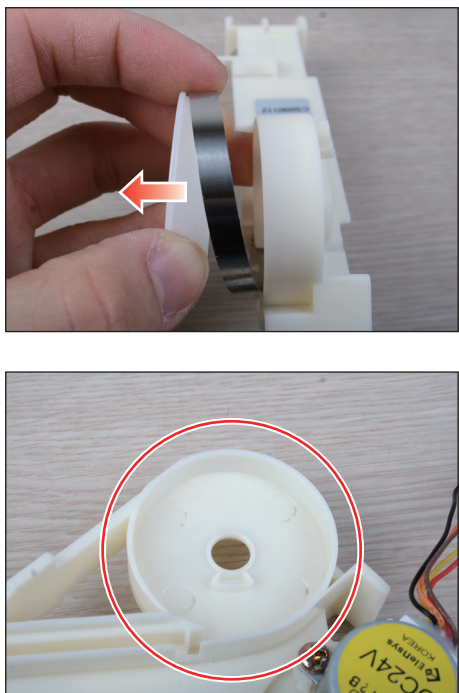
No.	Part name	Explanation	Reference picture
1	Move Motor	<p>1) Remove the screw fixing the Move Motor from the side of the Nozzle Assembly. : 4-M4x8</p> <p>2) Separate the Move Motor by pulling it in the direction of the arrow as shown in the figure. (The same for the other side motor.)</p>	
2	Plate String	<p>1) Separate the nozzle-driving plate spring by removing it in the direction of the arrow as shown in the figure. (This is the same for the other side motor.)</p> <p>2) This is a picture of the completely separated nozzle-driving plate spring.</p> <p>※ Since the plate spring is sharp, take care that you do not injure yourself.</p>	

4-2-7 Disassembling the Flow Volume Adjustment Valve Assembly / Air Pump

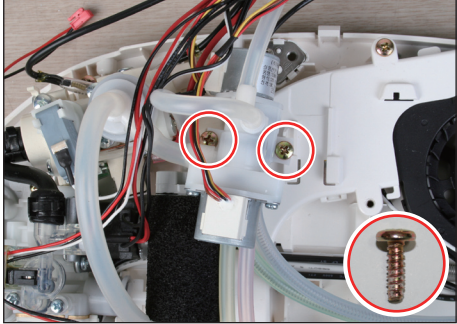
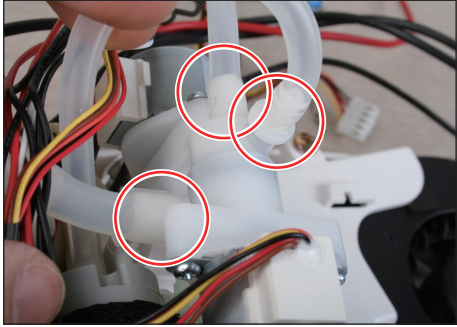
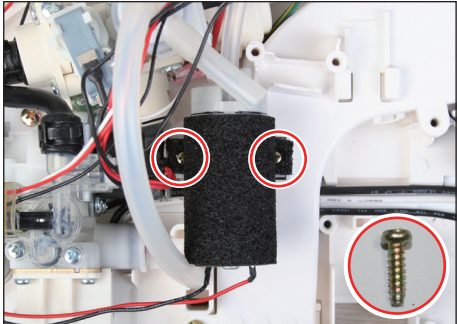
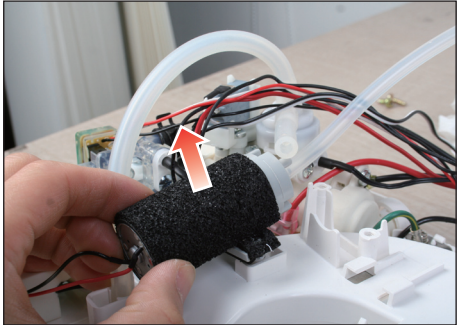
No.	Part name	Explanation	Reference picture
1	Flow Volume Adjustment Valve Assembly	<p>1) Remove the 2 screws from the Flow Volume Adjustment Valve Assembly. : 2-M4x12</p> <p>2) Separate the hose connected to the Flow Volume Adjustment Valve Assembly.</p>	 
2	Air Pump	<p>1) Remove the 2 screws from the Air Pump. : 2-M3x10</p> <p>2) Separate the Air Pump by removing it in the direction of the arrow as shown in the figure.</p>	 

4-2-8 Disassembling the Air Dryer Assembly

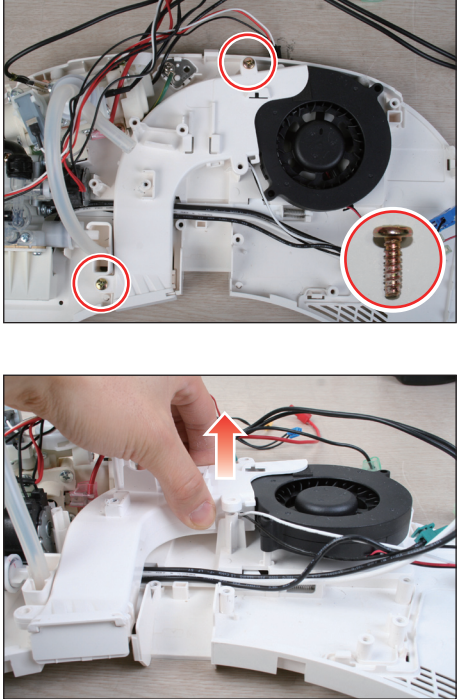
No.	Part name	Explanation	Reference picture
1	Air Dryer Assembly	<p>1) Remove the 2 screws from the Air Dryer Assembly. : 2-M4x12</p> <p>2) Remove the Air Dryer Assembly by removing it in the direction of the arrow.</p>	

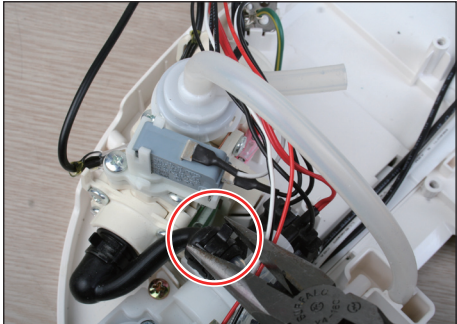
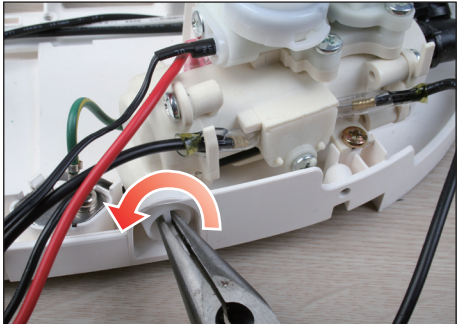
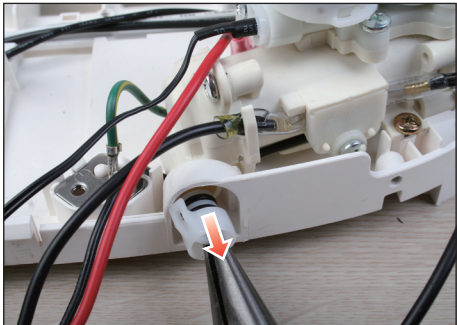
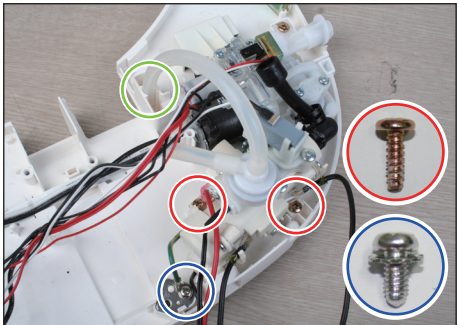
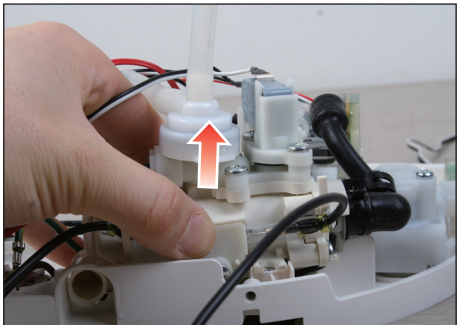

4-2-9 Disassembling the Instant Hot Water Assembly

No.	Part name	Explanation	Reference picture
1	Instant Hot Water Assembly	<p>1) Separate the clamp of the hose-band heater by stripping it.</p> <p>2) Separate the drain-cap by turning it and then pulling it forwards with a pair of long-nose pliers.</p> <p>3) Separate the 2 screws, the (1) ground wire, and the connected hoses of the Instant Hot Water Assembly. : 2-M4x12 - ○ : M4x8 with external washer - ○</p> <p>4) Remove the Instant Hot Water Assembly by removing it in the direction of the arrow.</p>	    

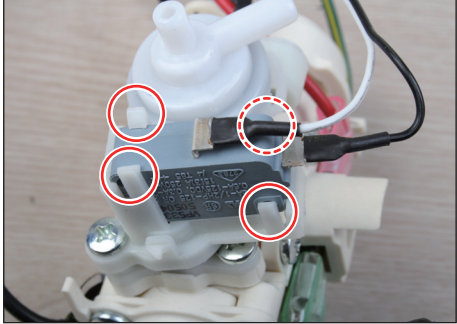
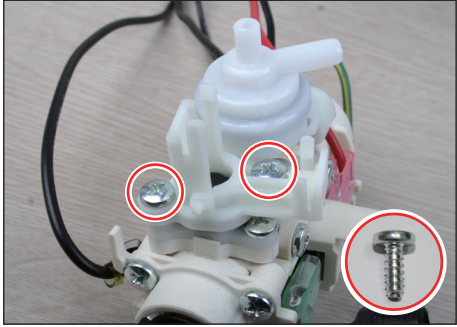
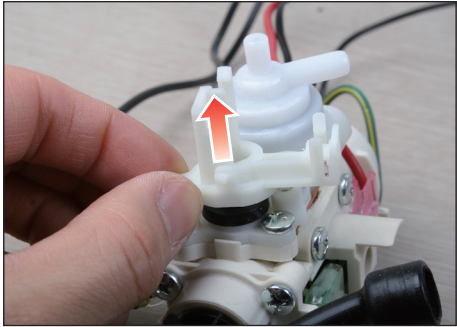
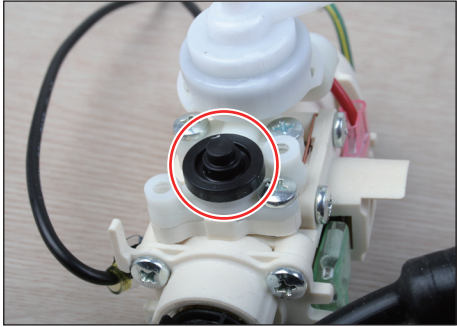
4-2-10 Disassembling the Instant Hot Water Assembly parts

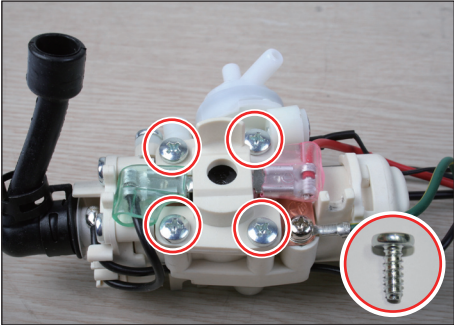
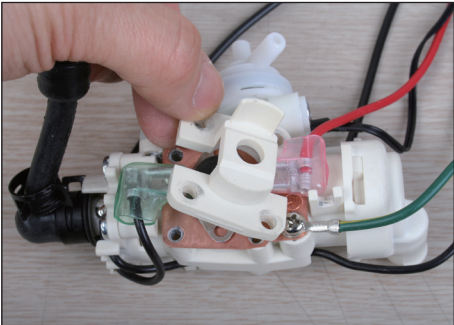
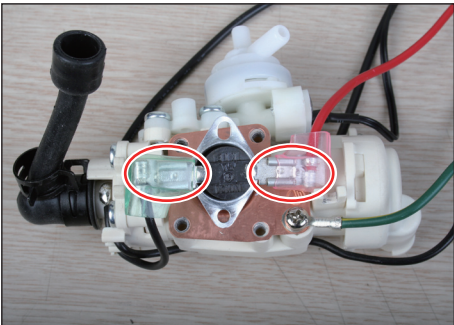
No.	Part name	Explanation	Reference picture
1	Micro-Switch	1) Separate the Micro-Switch by holding the 4 hooks of the Micro-Switch.	
2	Micro-Switch Housing	<p>1) Remove the 2 screws from the Micro-Switch Housing. : 2-M4x10</p> <p>2) Separate the Micro-Switch Housing by removing it in the direction of the arrow as shown in the figure.</p>	 
3	Micro-Switch Packing	1) Separate the Micro-Switch Packing.	

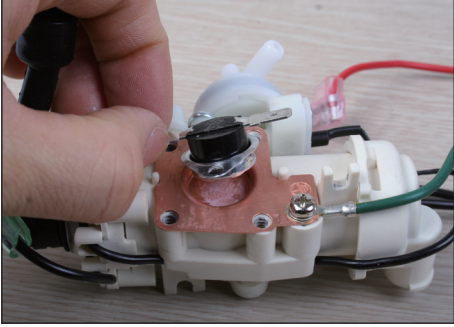
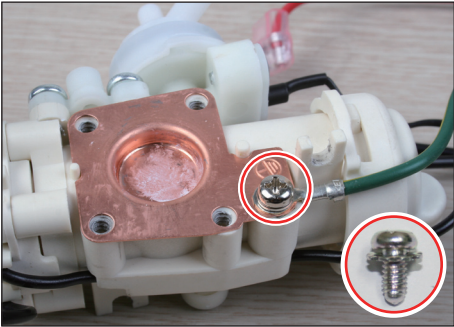
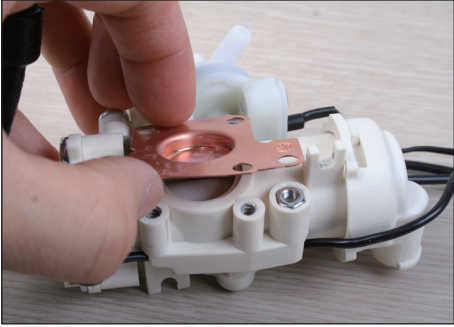
No.	Part name	Explanation	Reference picture
4	Bimetal Bracket	<p>1) Remove the 4 screws from the Bimetal-Bracket. : 4-M4x10</p> <p>2) Separate the Bimetal-Bracket.</p> <p>3) Separate the 2 terminals of the Bimetal.</p>	  

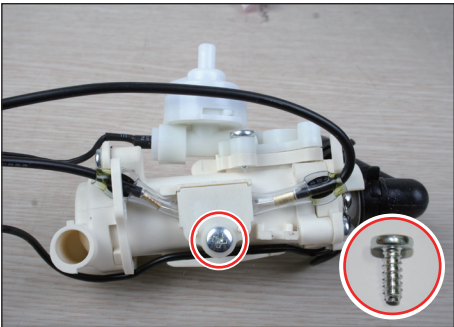
No.	Part name	Explanation	Reference picture
5	Bimetal Plate	<p>1) Separate the Bimetal.</p> <p>2) Remove the (1) ground wire and separate the Bimetal Plate. : M3x8</p> <p>3) Separate the O-ring.</p>	   
6	Fuse Plate	<p>1) Remove the single (1) screw from the Fuse Plate. : M4x10</p>	

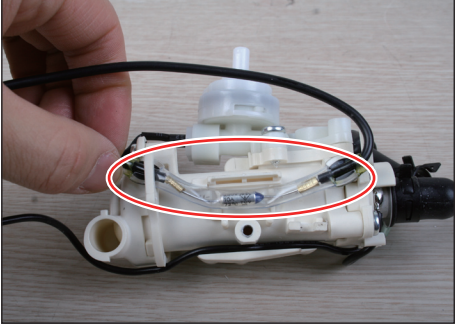
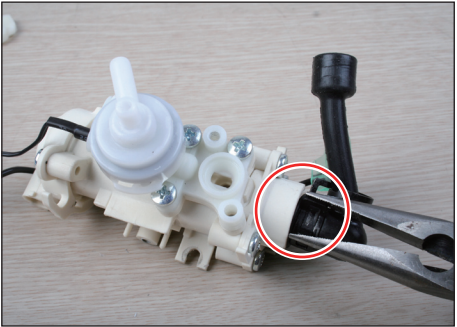
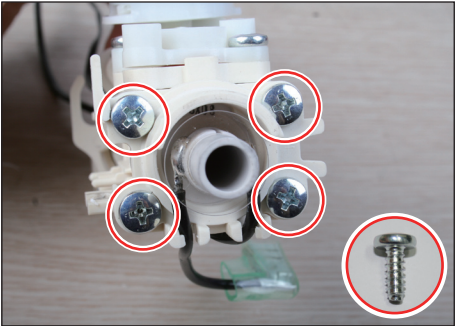
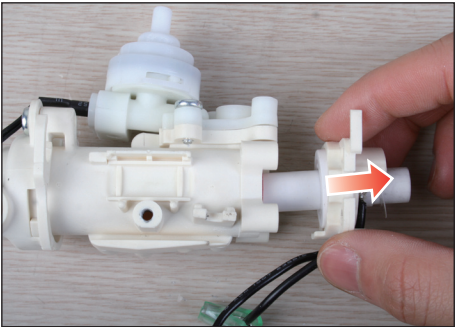
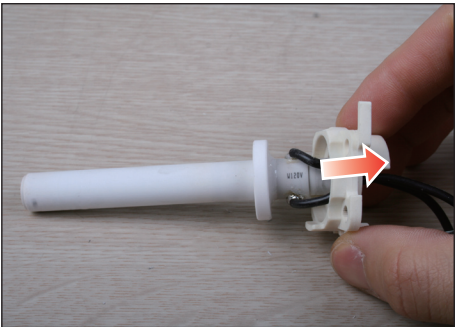
No.	Part name	Explanation	Reference picture
7	Fuse Assembly	1) Separate the Fuse Assembly.	
8	Hose-Band Heater	1) Separate the clamp of the hose-band heater by stripping it.	
9	Heater Bracket	<p>1) Remove the 4 screws from the Heater Bracket. : 4-M4x10</p> <p>2) Separate the Ceramic Heater by removing it in the direction of the arrow as shown in the figure.</p> <p>3) Separate the Ceramic Heater from the Heater Bracket by removing it in the direction of the arrow as shown in the figure.</p>	  

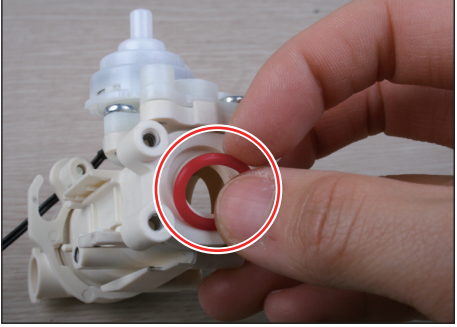
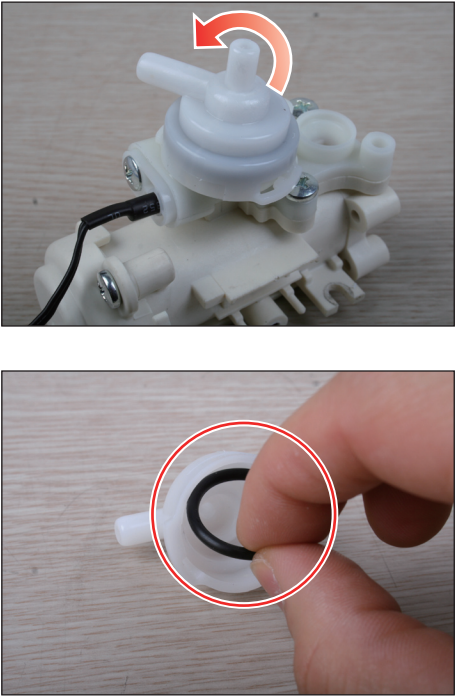
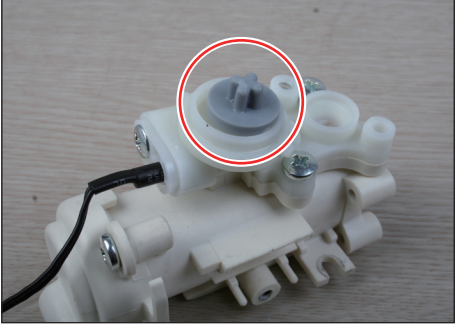
No.	Part name	Explanation	Reference picture
9	Heater Bracket	4) Separate the O-ring of the Heater Bracket.	
10	Outlet-Cap	<p>1) Separate the Outlet-Cap by turning it in the direction of the arrow as shown in the figure.</p> <p>2) Separate the O-ring of the Outlet-Cap.</p>	
11	Check Plate	1) Separate the Check Plate of the Outlet Housing.	

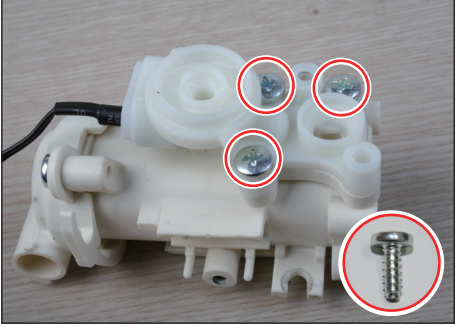
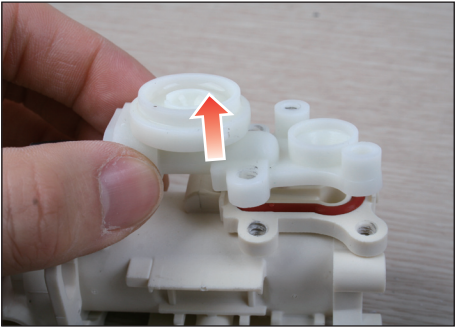
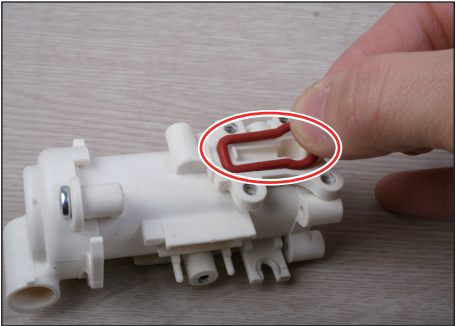
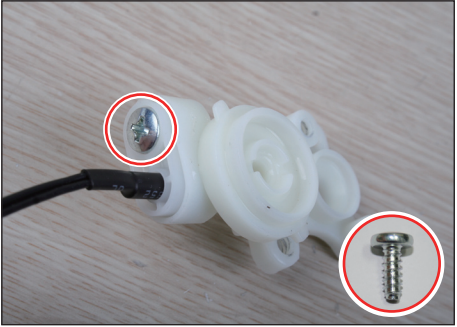
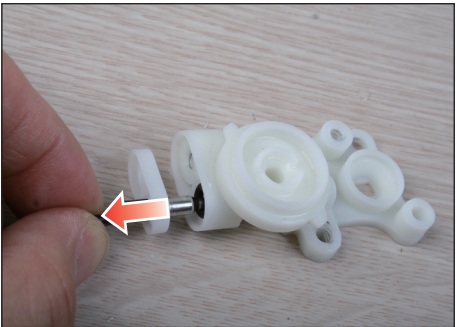
No.	Part name	Explanation	Reference picture
12	Outlet Housing	<p>1) Remove the 3 screws from the Outlet Housing. : 3-M4x10</p> <p>2) Separate the Outlet Housing by removing it in the direction of the arrow as shown in the figure.</p> <p>3) Separate the outlet packing.</p>	  
13	T2 Thermistor	<p>1) Remove the single (1) screw from the T2 Thermistor. : M4x10</p> <p>2) Separate the T2 Thermistor by removing it in the direction of the arrow as shown in the figure.</p>	 

4-2-11 Disassembling the Feed Water Valve Assembly

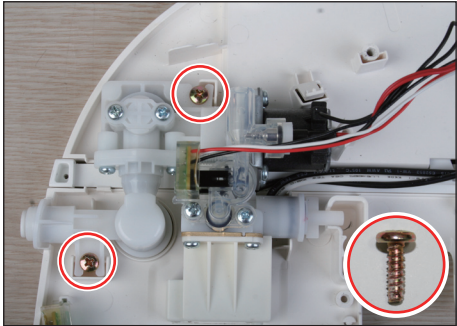
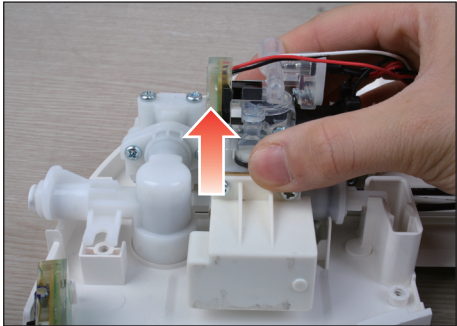
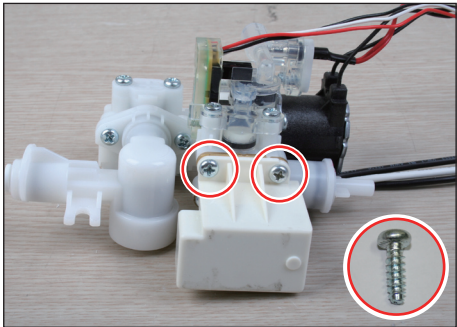
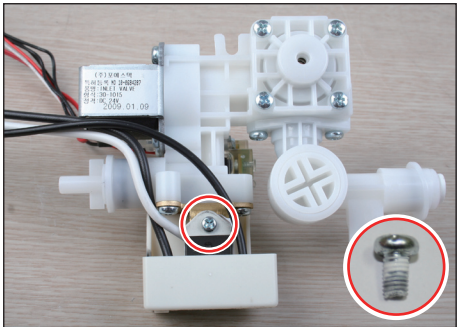
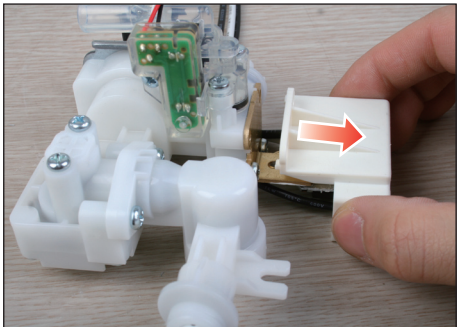
No.	Part name	Explanation	Reference picture
1	Feed Water Valve Assembly	<p>1) Remove the 2 screws from the Feed Water Valve Assembly. : 2-M4x12</p> <p>2) Remove the Feed Water Valve Assembly by removing it in the direction of the arrow.</p>	 
2	Triac	<p>1) Remove the 2 screws from the Triac. : 2-4x12</p> <p>2) Remove the single (1) screw from the back of the Triac. : 3x6</p> <p>3) Separate the Triac by removing it in the direction of the arrow as shown in the figure.</p>	  

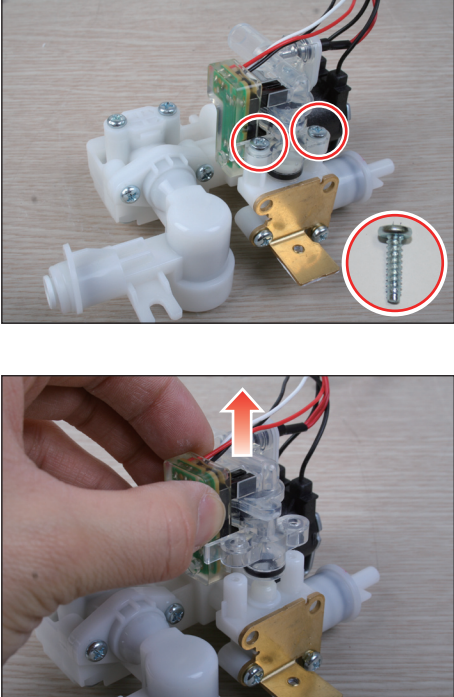
No.	Part name	Explanation	Reference picture
3	Flow Rate Sensor Assembly	<p>1) Remove the 2 screws from the Flow Rate Sensor Assembly. : 2-3x12</p> <p>2) Remove the Flow Rate Sensor Assembly by removing it in the direction of the arrow.</p>	 <p>The reference picture consists of two photographs. The top photograph shows a white plastic flow rate sensor assembly with a green PCB and a gold-colored metal plate. Two screws are circled in red, and a separate screw is also circled in red. The bottom photograph shows a hand lifting the sensor assembly away from the main unit, with a red arrow pointing upwards to indicate the direction of removal.</p>

4-2-12 Disassembling the Side PBA-L

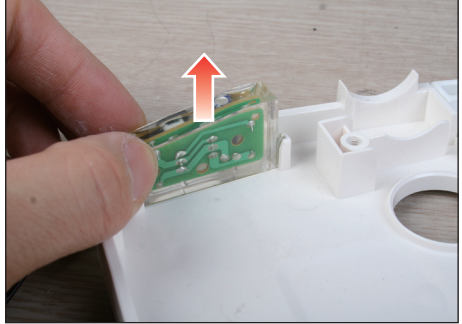
No.	Part name	Explanation	Reference picture
1	Side PBA-L	1) Separate the Side PBA-L by removing it in the direction of the arrow as shown in the figure.	

4-2-13 Disassembling the Fixer-Hook

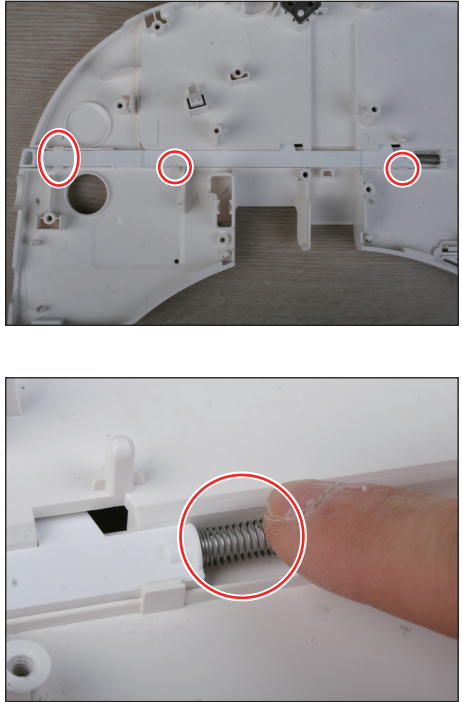
No.	Part name	Explanation	Reference picture
1	Fixer-Hook	1) Separate the Fixer-Hook by holding the 4 hooks of the body frame. Take care as the spring may come loose at this time.	

MEMO

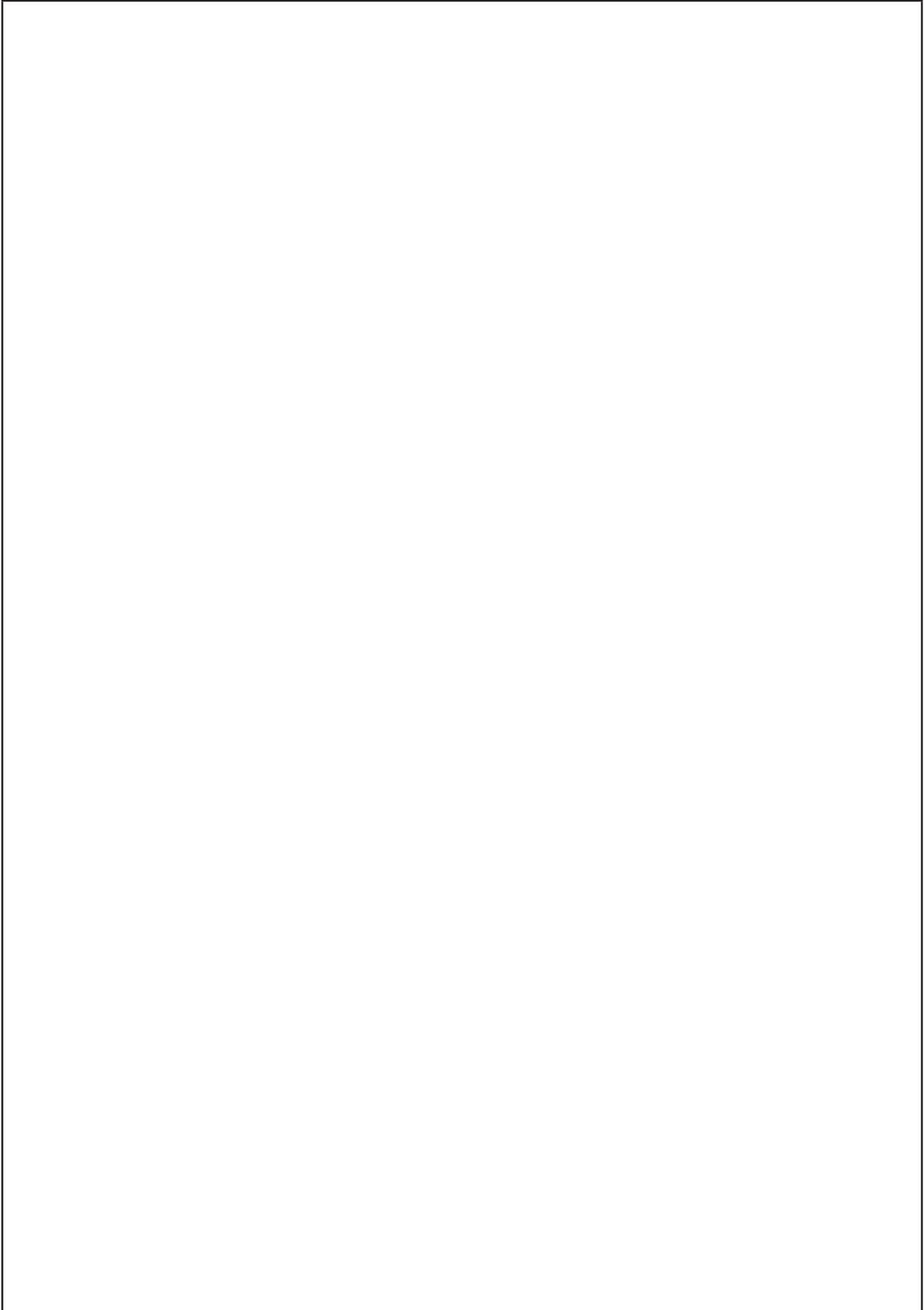

5. Fault diagnosis

5-1 Diagnosing and repairing faults

※ Refer to electrical wiring diagram when checking the product.

No.	Symptom	Checks	Measures
1	The power is not turned on.	Check if power is supplied.	Supply power.
		Check if the power cord is connected.	Supply power.
		Check the PBA (Main/Power/Sub) for abnormalities.	Replace the PBA if necessary.
2	The power is on but there is no sound.	Check if the Mute function is activated.	Cancel the Mute function.
		Check the Main-DC PBA patterns and the bell for faults or abnormalities.	Replace the Main-PBA if necessary.
3	Rear/front cleansing does not work.	Check if the PBA connector is connected properly.	Connect the connector properly.
		Check the Main-PBA for abnormalities.	Replace the Main-PBA if necessary.
		Check if the connecting hose is displaced or folded.	Correct the hose connection.
		Check if water is supplied normally.	Supply water.
		Check if the feed water sol valve is normal.	Replace the sol valve if necessary.
4	The dryer does not work.	Check if the multi-way valve is normal.	Replace the multi-way valve if necessary.
		Check the air dryer fan for abnormalities.	Replace the fan if necessary.
		Check the connectors and wires (Check the polarities as well).	Connect the connector properly. Replace the fan if necessary.
5	The air dryer temperature is room temperature only.	Check the operating power (PBA).	Replace the PBA if necessary.
		Check if the dryer heater is open-circuited.	Replace the dryer heater if necessary.
		Check if the temperature fuse of the dryer heater is blown.	Replace the dryer heater if necessary.
		Check the PBA for abnormalities.	Replace the PBA if necessary.













※ Refer to electrical wiring diagram when checking the product.













No.	Symptom	Checks	Measures
6	The air dryer temperature is hot only.	Check if the Triac of the dryer heater is open-circuited.	Replace the PBA if necessary.
		Check the PBA for abnormalities.	Replace the PBA if necessary.
7	The nozzle does not move (including the nozzle position adjustment).	Check the connection of the connector (check the polarities as well.).	Correct the connector polarity, if necessary.
		Check whether anything is interfering with the hose connected to the nozzle.	Connect the hose properly, if necessary.
		Check the output waveform of the Level Motor.	Replace the Main PBA if necessary.
8	The water pressure adjustment is not working.	Check if the multi-way valve is normal.	Replace the multi-way valve if necessary.
		Check the Main PBA for abnormalities.	Replace the Main PBA if necessary.
9	Nozzle cleansing does not work.	Check if it works when the power is on.	This only works when the power is turned on.
		Check if the move motor is normal.	Replace the nozzle assembly if necessary.
		Check the PBA for abnormalities.	Replace the PBA if necessary.
10	Water leaks.	Check if the water leaks from the water tank.	Replace the water tank or tighten the bolts.
		Check if the hose is displayed.	Connect the hose properly if necessary.
11	Water comes out through the nozzle while the product is not in use.	Check if the feed water sol valve is normal.	Replace the feed water valve if necessary.
		Check if the water level sensor is normal.	Replace the water level sensor if necessary.

※ Refer to electrical wiring diagram when checking the product.

No.	Symptom	Checks	Measures
12	No water is supplied.	Check if the water supply is normal.	Supply water if necessary.
		Check if the feed water sol valve is normal.	Replace the feed water valve if necessary.
		Check if the water level sensor is normal.	Replace the water level sensor if necessary.
		Check the Main PBA for abnormalities.	Replace the Main PBA if necessary.
13	No warm water comes out.	Check if the hot water heater is not open-circuited.	Replace the hot water heater if necessary.
		Check if the PBA is normal.	Replace the PBA if necessary.
		Check if the bimetal is normal.	Replace the bimetal if necessary.
		Check if the temperature fuse is normal.	Replace the temperature fuse.
14	The nozzle does not fully extend.	Check if the move motor is normal.	Replace the nozzle assembly if necessary.
		Check if the Main-PBA is normal.	Replace the Main-PBA if necessary.
15	During the rear/front cleansing operation, the nozzle is fully extended but no water comes out.	Check if the water supply is normal.	Supply water if necessary.
		Check if the feed water Sol valve is normal.	Replace the feed water valve if necessary.
16	The remote control does not work.	Check if the batteries in the remote control are flat.	Replace the batteries.
		Check if the remote control PBA is normal.	Replace the PBA if necessary.
		Check if the main body PBA is normal.	Replace the PBA if necessary.

5-2 Checking methods per error mode

No.	LED indication	Symptom	Possible cause	Indication method	LED / buzzer state
1	<ul style="list-style-type: none">  power  eco mode  seat temp. 	The water temperature does not increase even if a higher temperature is selected.	<ol style="list-style-type: none"> 1. The temperature Sensor (T2) is faulty. 2. The PBA is faulty. 3. The Ceramic Heater is faulty. 	<ol style="list-style-type: none"> 1. If this state continues for 7 seconds or longer, an error is detected. 	<p>Error Code 1 Bell: Rings. LED: The Seat LED blinks.</p>
2	<ul style="list-style-type: none">  power  eco mode  seat temp. 	The water flow rate is 150 cc or slower.	<ol style="list-style-type: none"> 1. The supply water valve is closed. 2. The feed water sol valve is faulty. 3. The flow Rate Sensor is faulty. 4. The filter is clogged. 5. The PBA is faulty. 6. Water leaks. 	<ol style="list-style-type: none"> 1. If this state continues for 200 ms or longer, an error is detected. 2. Insert the nozzle and wait. 3. This works normally when the amount of water is 200 cc or more. 	<p>Error Code 2 Bell: Rings once. LED: None.</p>
3	<ul style="list-style-type: none">  power  eco mode  seat temp. 	This occurs when the seat temperature sensor detects a temperature of 51 °C or higher (when the Flow Rate Sensor is working).	<ol style="list-style-type: none"> 1. The seat heater is faulty. 2. The seat temperature sensor is faulty. 3. The PBA is faulty. 	<ol style="list-style-type: none"> 1. If this state continues for 2 seconds or longer, the error is detected. 2. When the power is turned on again, the error is cleared. 	<p>Error Code 3 Bell: Rings. LED: The Power Saving and Seat LEDs blink.</p>
4	<ul style="list-style-type: none">  power  eco mode  seat temp. 	This occurs when the feed water temperature (T1) is 41 °C or higher.	<ol style="list-style-type: none"> 1. The temperature Sensor (T1) is faulty. 2. The PBA is faulty. 	<ol style="list-style-type: none"> 1. If this state continues for 2 seconds or longer, an error is detected. 2. When the power is turned on again, the error is cleared. 	<p>Error Code 4 Bell: Rings. LED: The Power LED blinks.</p>

No.	LED indication	Symptom	Possible cause	Indication method	LED / buzzer state
5	 power  eco mode  seat temp.	<p>This occurs when the feed water temperature (T2) is 45 °C or higher.</p>	<ol style="list-style-type: none"> 1. The temperature Sensor (T2) is faulty. 2. The PBA is faulty. 	<ol style="list-style-type: none"> 1. If this state continues for 100 ms or longer, the error is detected. 2. Performs self-cleansing after 10 seconds. 3. When the feed water temperature difference is 5 °C or less, the error is cleared. 	<p>Error Code 4 Bell: Rings. LED: The Power LED blinks.</p>
6	 power  eco mode  seat temp.	<p>Voltage 120 V : An error is detected when the voltage is 87 V or lower or the voltage is 150 V or higher.</p> <p>Voltage 240 V : An error is detected when the voltage is 190 V or lower or the voltage is 290 V or higher.</p>	<ol style="list-style-type: none"> 1. The input power voltage is unstable. 2. The PBA is faulty. 	<ol style="list-style-type: none"> 1. An error is detected 3 seconds after turning the power on. 2. An error is detected when it is detected for 2 seconds or longer (± 5 V) 3. This is automatically restored when the power voltage is normal. 4. The error is cleared 10 seconds after the power is restored. 	<p>Error Code 5 LED: The Power and Seat LEDs blink.</p>
7	 power  eco mode  seat temp.	<p>Frequency 60 Hz: An error is detected when the frequency is 55 Hz or lower or the frequency is 65 Hz or higher.</p> <p>50 Hz: An error is detected when the frequency is 45 Hz or lower or the frequency is 55 Hz or higher.</p>	<ol style="list-style-type: none"> 1. The input power frequency is unstable. 2. The PBA is faulty. 	<ol style="list-style-type: none"> 1. An error is detected 3 seconds after turning the power on. 2. An error is detected when it is detected for 2 seconds or longer (± 1 Hz) 	<p>Error Code 5 Bell: Rings. LED: The Power and Seat LEDs blink.</p>
8	 power  eco mode  seat temp.	<p>An open-circuit or short-circuit of the temperature sensors T1, T2, or the seat temperature sensor is detected.</p>	<ol style="list-style-type: none"> 1. The temperature sensor is faulty. 2. The PBA is faulty. 3. A short-circuit occurs due to a water leakage. 	<ol style="list-style-type: none"> 1. If this state is detected for 100 ms or longer, an error is detected. 	<p>Error Code 6 Bell: Rings. LED: The Power and Power-Saving LEDs blink.</p>

6. Exploded view of the system and the list of service parts

6-1 Exploded view and parts list of BA13-AR/AE/BR/BE

This document is Coway's technical property. Only the person approved by the company may use this document.

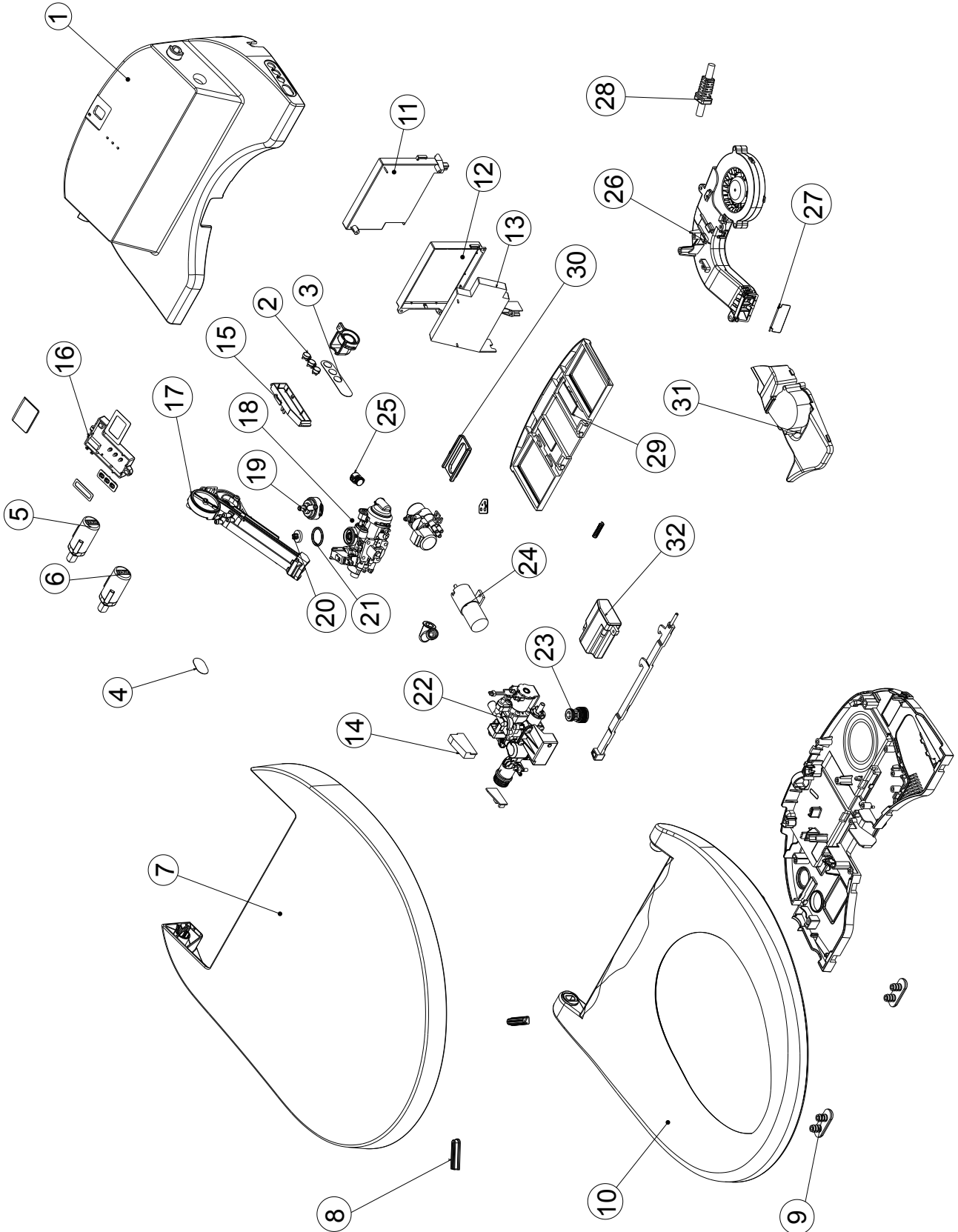

■ Parts List

No.	Description	Q'ty	Remark
1	ASS'Y COVER-TOP SEMI (BA13)	1	
2	BUTTON-SIDE RIGHT	1	
3	INLAY-BUTTON (BA13)	1	
4	INLAY-IR (BA13)	1	
5	DAMPER-SINGLE AXLE SPRING COVER ASSY (BA13) E TYPE	1	BA13-AE/BE
	DAMPER-SINGLE AXLE SPRING COVER ASSY (BA13) R TYPE	1	BA13-AR/BR
6	DAMPER-SINGLE AXLE SPRING SEAT ASSY (BA13) E TYPE	1	BA13-AE/BE
	DAMPER-SINGLE AXLE SPRING SEAT ASSY (BA13) R TYPE	1	BA13-AR/BR
7	COVER-SEAT E ASSY (BA13)	1	BA13-AE/BE
	COVER-SEAT R ASSY (BA13)	1	BA13-AR/BR
8	CUSHION-COVER (BA13)	2	
9	CUSHION-SEAT (BA13)	2	
10	A/S SEAT-E ASSY (BA13)	1	BA13-AE/BE
	A/S SEAT-R ASSY (BA13)	1	BA13-AR/BR
11	PBA-MAIN ASSY (BA13)	1	
12	PBA-POWER ASSY (BA13)	1	
13	PBA-SMPS ASSY (BA13)	1	
14	PBA-SIDE LEFT ASSY (BA13)	1	
15	PBA-SIDE RIGHT ASSY (BA13)	1	
16	PBA-LED ASSY (BA13)	1	
17	NOZZLE ASSY (BA13)	1	
18	TANK-INSTANT HEATING ASSY (BA13)	1	
19	CAP-OUTLET (BA13)	1	
20	PLATE-CHECK (BA13)	1	
21	O-RING-P20-OUTLET (BA13)	1	
22	VALVE-SOLENOID REDUCING TRIAC ASSY (BA13)	1	
23	FILTER-ASSY MESH	1	
24	PUMP-AIR ASSY (BA13)	1	
25	CAP-DRAIN ASSY (BA13)	1	
26	MOTOR-FAN DRYER ASSY (BA13)	1	
27	DOOR-WIND (BA13)	1	
28	POWER CORD ASSY (BA13)	1	
29	FIXER-BRACKET ASSY	1	
30	BRACKET-FIXER SLIDE	1	
31	MOTOR-FAN DEODORIZING ASSY	1	
32	FILTER-STERILIZATION ASSY	1	

6-2 Exploded view and parts list of Nozzle-Assy

This document is Coway's technical property. Only the person approved by the company may use this document.

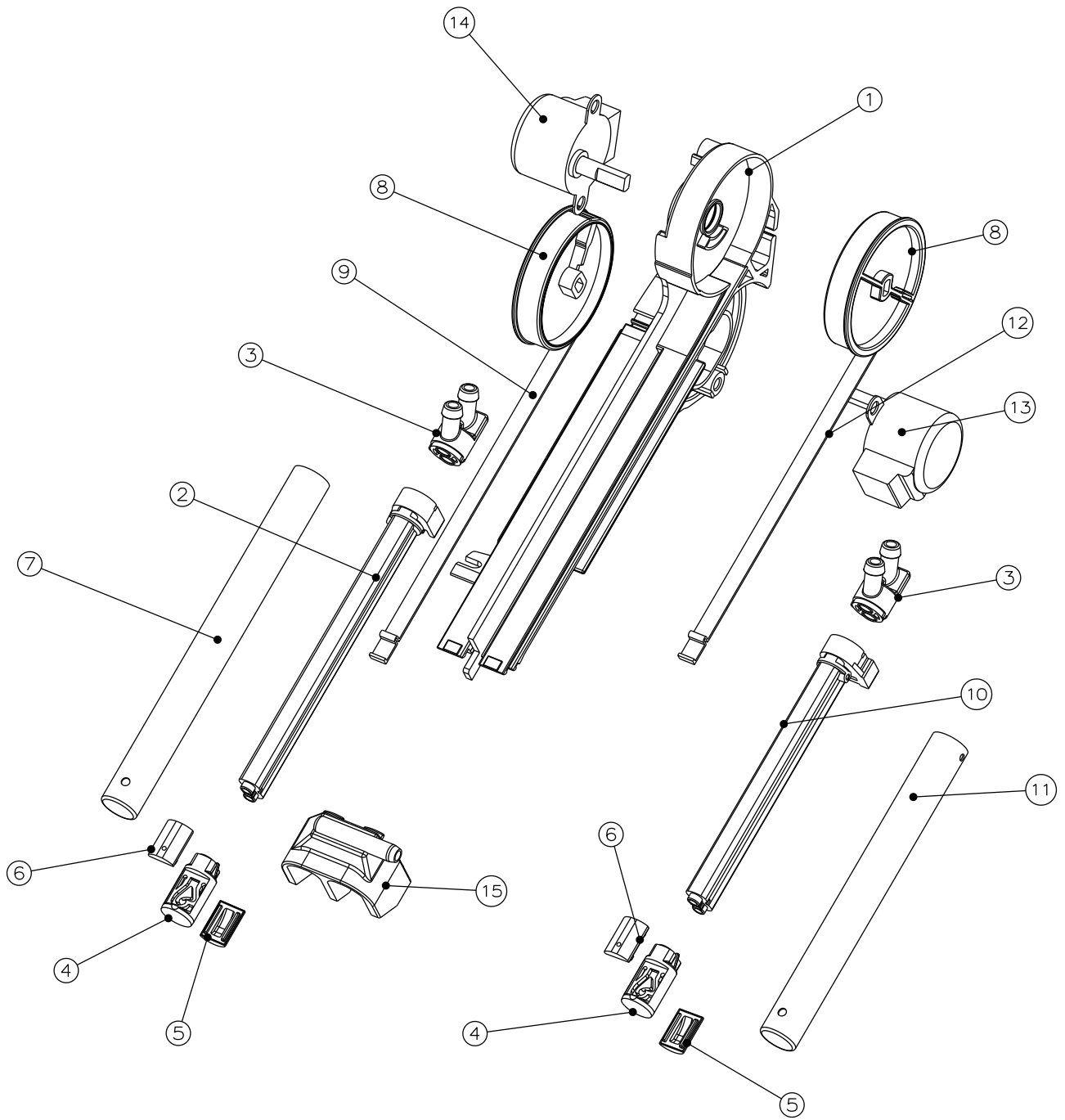

■ Parts List

No.	Description	Q'ty	Remark
1	BODY-NOZZLE	1	
2	CYLINDER-BIDET	1	
3	CONNECTOR-NOZZLE	1	
4	TIP-NOZZLE	1	
5	TIP-LOWER	1	
6	TIP-UPPER	1	
7	CYLINDER-BIDET STS	1	
8	PULLEY	1	
9	PLATE-SPRING	1	
10	CYLINDER-CLEAN	1	
11	CYLINDER-CLEAN STS	1	
12	PLATE-SPRING	1	
13	MOTOR-MOVE B	1	
14	MOTOR-MOVE C	1	
15	DUCT-NOZZLE	1	

6-3 Service parts list of BA13-AR/AE/BR/BE

Code No.	Description	Specification	Q'ty	Remark
3210947	ASS'Y COVER-TOP SEMI (BA13)	Flame-retardant ABS, WHITE	1	
3210938	BUTTON-SIDE RIGHT	PP Honam Petrochemical Corporation 5320 (871008) White	1	
3302330	INLAY-REMOTE CONTROLLER (BA13-A)	SKC PET 0.188 t + BOW110QJT BA13-A	1	
3211036	INLAY-REMOTE CONTROLLER (BA13-B)	SKC PET 0.188 t + BOW110QJT BA13-B	1	
3210939	INLAY-BUTTON (BA13)	SKC PET 0.2 t + BOW110QJT	1	
3210940	INLAY-IR (BA13)	PET SKC 0.188 t + BOW110QJT	1	
3110921	DAMPER-SINGLE AXLE SPRING COVER ASSY (BA13) E TYPE	OIL SPRING 12 K for Seat Cover	1	
3110920	DAMPER-SINGLE AXLE SPRING SEAT ASSY (BA13) E TYPE	OIL SPRING 18 K for Seat	1	
3302197	DAMPER-SINGLE AXLE SPRING COVER ASSY (BA13) R TYPE	OIL SPRING 10 K for Seat Cover	1	
3302198	DAMPER-SINGLE AXLE SPRING SEAT ASSY (BA13) R TYPE	OIL SPRING 16 K for Seat	1	
3110977	COVER-SEAT R ASSY (BA13)	ABS, WHITE	1	
3110924	COVER-SEAT E ASSY (BA13)	ABS, WHITE	1	
3302199	CUSHION-COVER (BA13)	SILICONE, GRAY	2	
3106923	CUSHION-SEAT (BA13)	SOFT PVC 65HrC GRAY	2	
3110922	A/S SEAT-E ASSY (BA13)	110 V~ 60 W Flame-retardant ABS LGAF345 ELONGATE	1	
3110976	A/S SEAT-R ASSY (BA13)	110 V~ 60 W Flame-retardant ABS LGAF345 ROUND	1	
3110954	PBA-MAIN ASSY (BA13)	PC Transparent	1	
3110955	PBA-POWER ASSY (BA13)	Single Side 1.6 T 94 V- 0 120 V Flame-retardant ABS Injection	1	
3110956	PBA-SMPS ASSY (BA13)	single side 1.6 T 94 V-0	1	
3110926	PBA-SIDE LEFT ASSY (BA13)	IR Sensor	1	
3110919	PBA-SIDE RIGHT ASSY (BA13)	PC Transparent	1	
3302200	PBA-LED ASSY (BA13)	PC Transparent	1	
3302331	REMOTE CONTROLLER ASSY (BA13-A)	BA13-AR/AE	1	
3110975	REMOTE CONTROLLER ASSY (BA13-B)	BA13-BR/BE	1	
3211020	COVER-BATTERY ASSY (BA13)	LG ABS SG175 (08456C)	1	
3110950	NOZZLE ASSY (BA13)	STS Nozzle Assembly	1	

Code No.	Description	Specification	Q'ty	Remark
3110928	TANK-INSTANT HEATING ASSY (BA13)	120 V~ 1250 W Auto Bimetal 50 °C	1	
3110938	CAP-OUTLET (BA13)	POM Korea EP F20-03	1	
3302201	PLATE-CHECK (BA13)	EPDM	1	
3302202	O-RING-P20-OUTLET (BA13)	EPDM P20	1	
3111326	VALVE-SOLENOID REDUCING TRIAC ASSY (BA13)-BARID HOSE	DC 24 V Decompression 0.9 ± 0.25 kg/cm ² Safety Valve 1.5 kg/cm ² Triac (600V 25A) Flame-retardant Molding, BARID Hose	1	
3110927	VALVE-SOLENOID REDUCING TRIAC ASSY (BA13)-TUBING HOSE	DC 24 V Decompression 0.9 ± 0.25 kg/cm ² Safety Valve 1.5 kg/cm ² Triac (600 V 25 A) Flame-retardant Molding, TUBING HOSE	1	
3302203	FILTER-ASSY MESH	DC 24 V	1	
3302204	PUMP-AIR ASSY (BA13)	DC 24 V	1	
3110948	CAP-DRAIN ASSY (BA13)	POM Korea EP F20-03	1	
3110951	MOTOR-FAN DRYER ASSY (BA13)	Flame-retardant ABS 120 V~ 180 W DC 24 V	1	
3211004	DOOR-WIND (BA13)	PP (Flame-retardant) LG GP-3152F	1	
3110952	POWER CORD ASSY (BA13)	AC 120 V 16 A 3CX0.75 cm ² 1.1 M WHITE	1	
3110966	INSTALL ADAPTER-7/8	BA13, Pipe 7/8 inch, Sus Braid Hose PF 1/2 inch	1	
3300533	INSTALL ADAPTER-7/8	Common Use, Pipe 7/8 inch, Tubing 1/4 inch	1	
3010023	BOLT-INSTALL ASSY (BA07)	POM	2	
3211021	BRACKET-REMOTE CONTROL ASSY (BA13)	LG ABS SG175 (08456C)	1	
3110967	FIXER-BRACKET ASSY	LG LGP2200 NATURAL	1	
3110968	BRACKET-FIXER SLIDE	NYLON66+GF20%	1	
3110958	MOTOR-FAN DEODORIZING ASSY (BA13)	DC 24 V, 4000 RPM PP (with filter)	1	
3110957	FILTER-STERILIZATION ASSY	50 CC	1	

MEMO

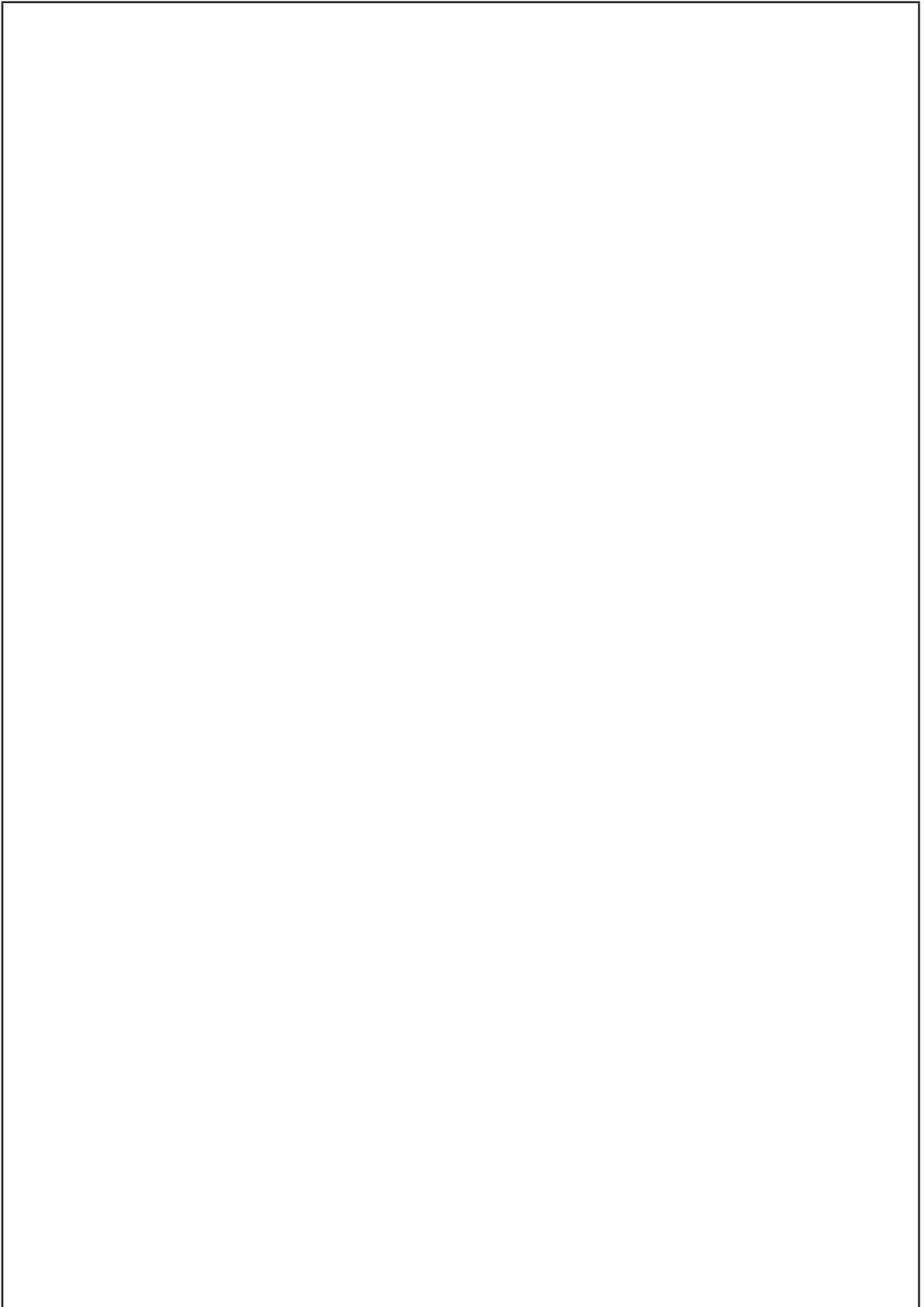

7. Parts location diagrams

7-1 Electrical wiring diagram

This document is Coway's technical property. Only the person approved by the company may use this document.

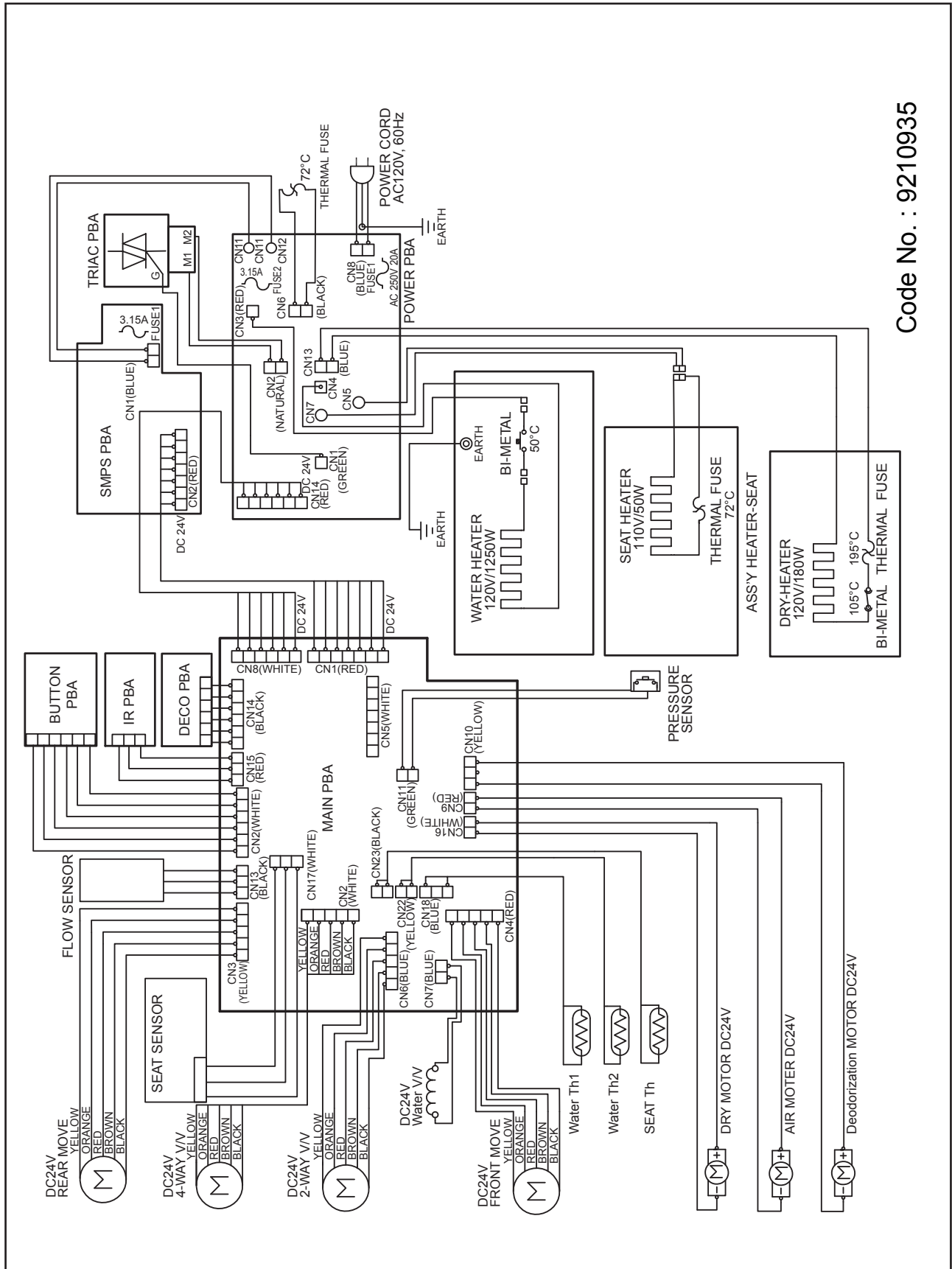

Code No. : 9210935

7-2 PBA location diagram

7-2-1 MAIN PBA

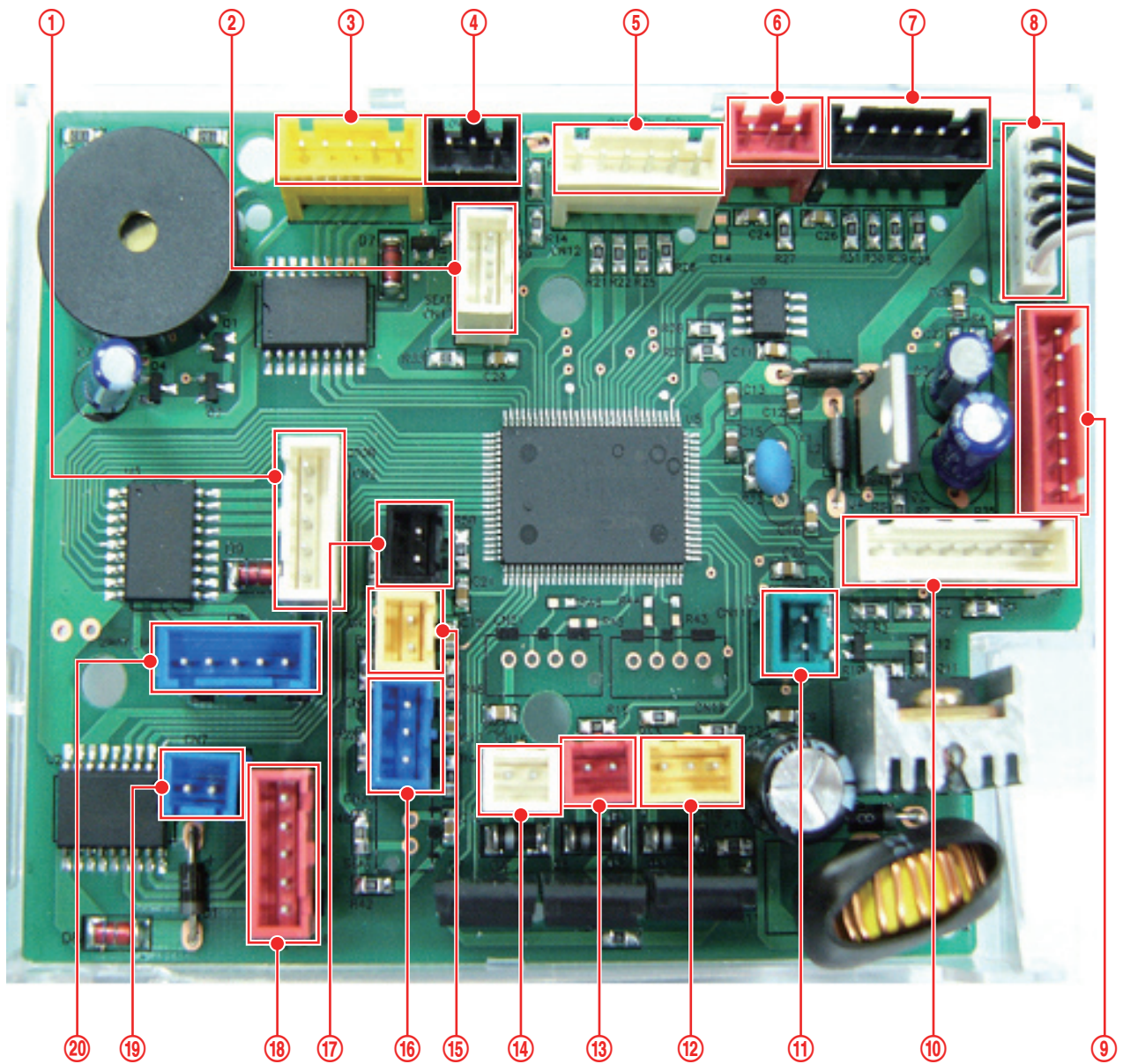

① CN2
4way Motor

Pin No.	Signal
1~4	(-)
5	24V(+)

② CN17
Seat Sensor

Pin No.	Signal
1	GND
2	5V(+)
3	TC_Sensor

③ CN3
Move Motor Up

Pin No.	Signal
1~4	(-)
5	24V(+)

④ CN13
Flow Sensor

Pin No.	Signal
1	5V(+)
2	Flowmeter
3	GND

⑤ CN12
Button_Right

Pin No.	Signal
1	GND
2	IR_Receiver
3~5	S/W
6	5V(+)

⑥ CN15
IR_Left

Pin No.	Signal
1	GND
2	IR_Receiver
3	5V(+)

⑦ CN14
Deco_LED

Pin No.	Signal
1	5V(+)
2	LED1
3	LED2
4	LED3
5	IR_Receiver
6	GND

⑧ CN8
Main ↔ Power

Pin No.	Signal
1	24V(+)
2	cut_off
3	D/heater
4	S/heater
5	W/heater
6	GND

⑨ CN1
Main ↔ SMPS

Pin No.	Signal
1	24V(+)
2	8.5V(+)
3	5V(+)
4	zero_con
5	GND
6	zero_cross
7	zero_volt

⑩ CN5
Debug Port

⑪ CN11
Micro S/W

Pin No.	Signal
1	pressure_sensor
2	5V(+)

⑫ CN10
Deodorization Motor

Pin No.	Signal
1	24V(+)
2	GND

Parts location diagrams

⑬ CN9
Air Motor

Pin No.	Signal
1	24V(+)
2	GND

⑭ CN16
Dry Motor

Pin No.	Signal
1	24V(+)
2	GND

⑮ CN22
(Temperature Sensor_T2)

Pin No.	Signal
1	5V(+) water temp.2
2	GND

⑯ CN18
(Temperature Sensor_T1)

Pin No.	Signal
1	5V(+) water temp.1
2	-
3	GND

⑰ CN23
(Temperature Sensor_Seat)

Pin No.	Signal
1	5V(+) seat temp.
2	GND

⑱ CN4
Move Motor Down

Pin No.	Signal
1~4	(-)
5	24V(+)

⑲ CN7
Water IN v/v

Pin No.	Signal
1	24V(+)
2	high: (-), low: 24V(+)

⑳ CN6
2way Motor

Pin No.	Signal
1~4	(-)
5	24V(+)

7-2-2 POWER PBA

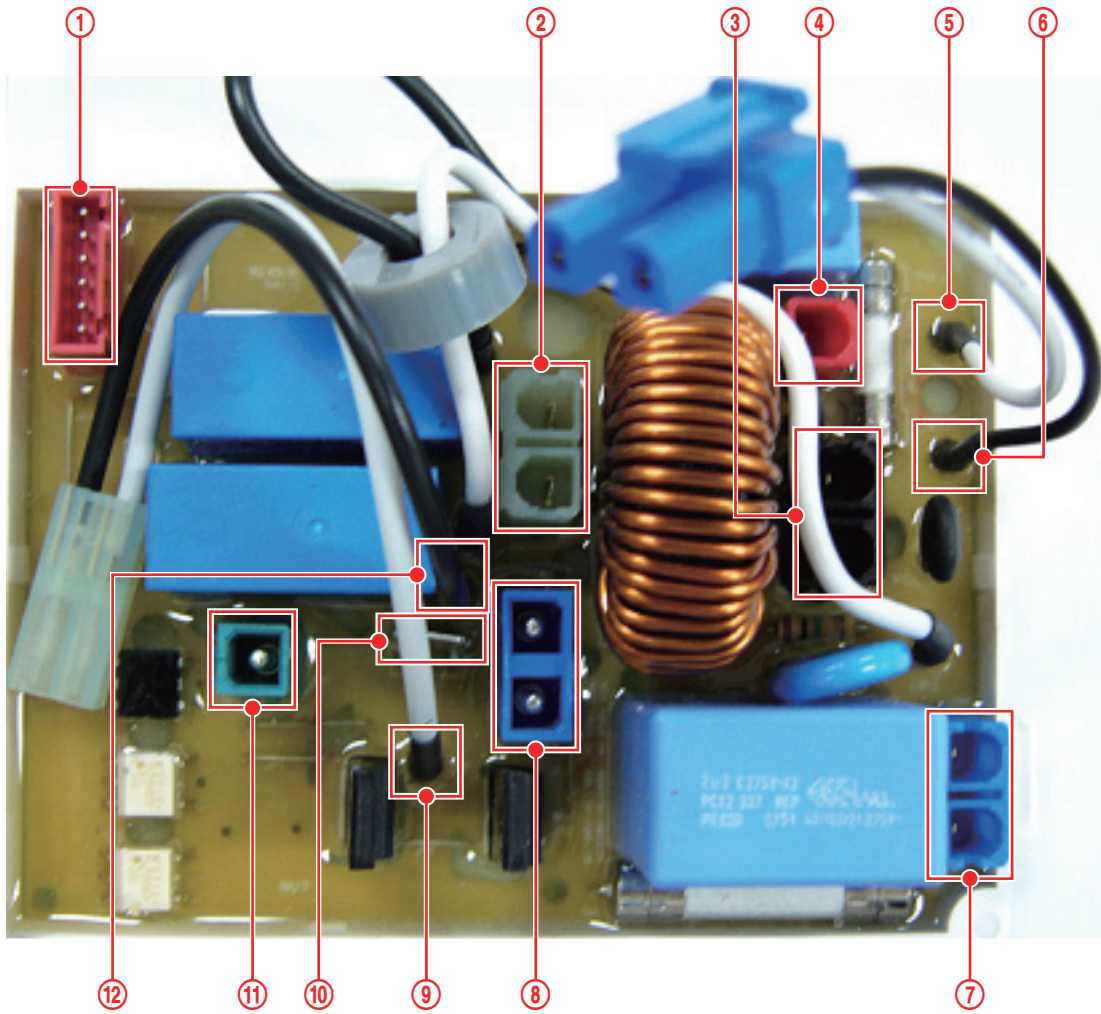

① CN14
Data port

Pin No.	Signal
1	24V(+)
2	ZCT
3	Dry_Heater
4	Seat_Heater
5	Water_Heater
6	GND(GS)

② CN2
TriAc

Pin No.	Signal
1	M1
2	M2

⑦ CN8
AC Power

Pin No.	Signal
1	AC Power L
2	AC Power N

③ CN6: Temp. fuse

④ CN3: Water Heater A

⑤ CN11: AC Power to SMPS

⑥ CN12: AC Power to SMPS

⑧ CN13: Dry_Heater

⑨ CN5: Seat Heater A

⑩ CN4: Water Heater B

⑪ CN1
TriAc

Pin No.	Signal
1	gate

⑫ CN7: Seat Heater B

7-2-3 DECO_LED PBA

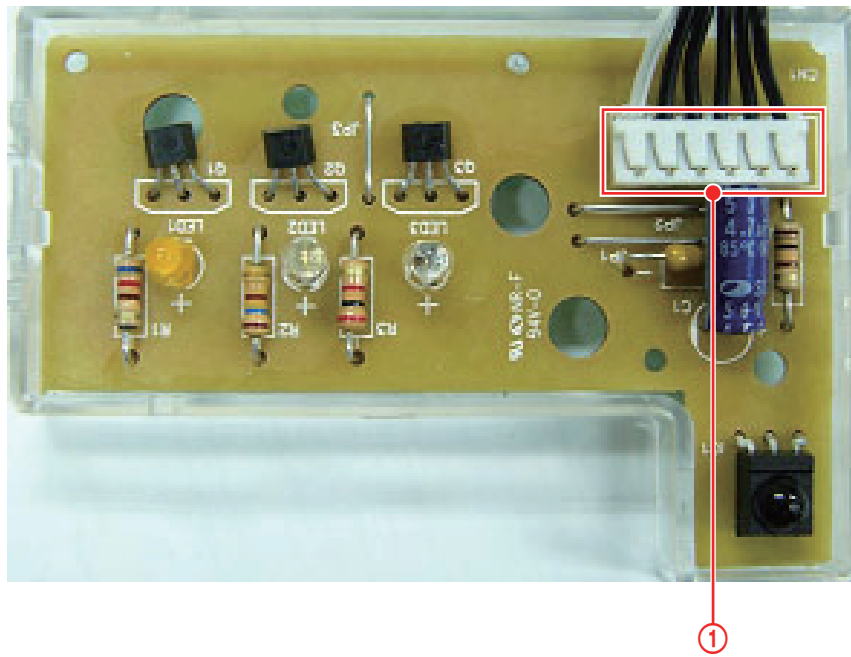

① CN1

Main ↔ DECO_LED PBA

Pin No.	Signal
1	5V(+)
2	LED1
3	LED2
4	LED3
5	IR_Receiver
6	GND

7-2-4 BUTTON PBA

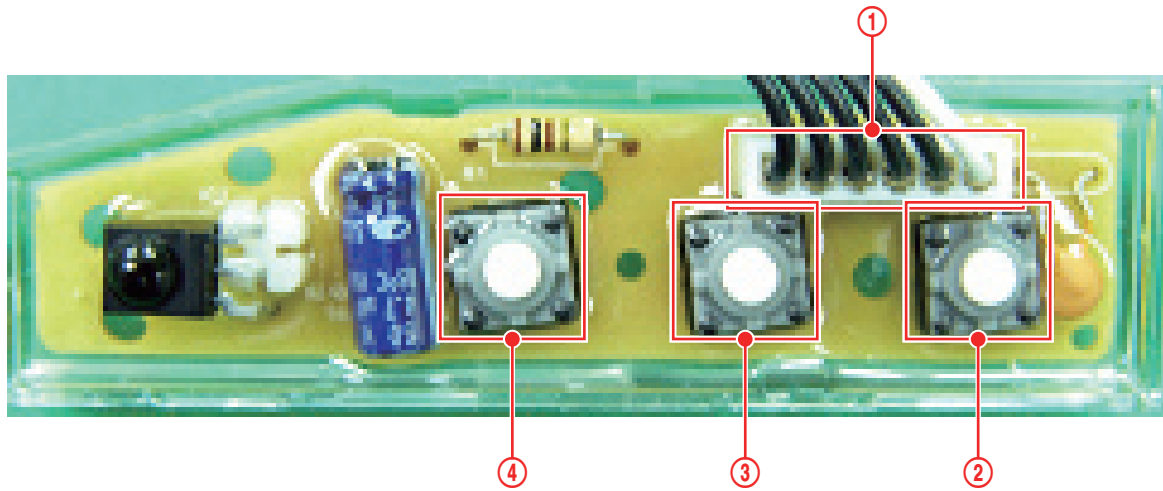

① CN1
Button_Right

Pin No.	Signal
1	GND
2	IR_Receiver
3~5	S/W
6	5V(+)

② SW3: Nozzle Cleaning

③ SW2: Rear Cleansing

④ SW1: Power

7-2-5 IR PBA

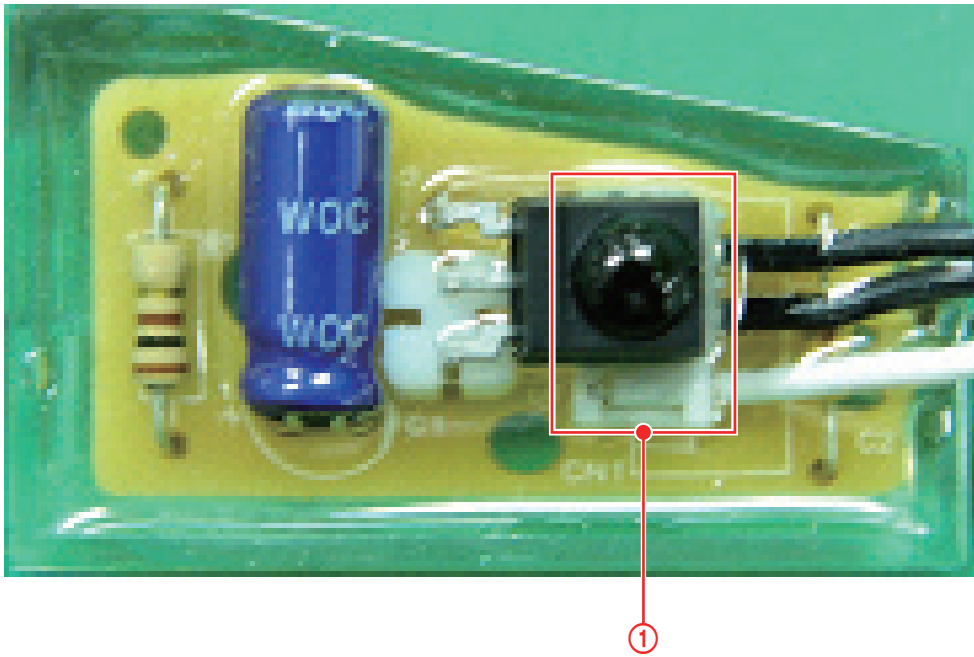

① CN1
IR_Left

Pin No.	Signal
1	GND
2	IR_Receiver
3	5V(+)

7-2-6 REMOTE CONTROL PBA

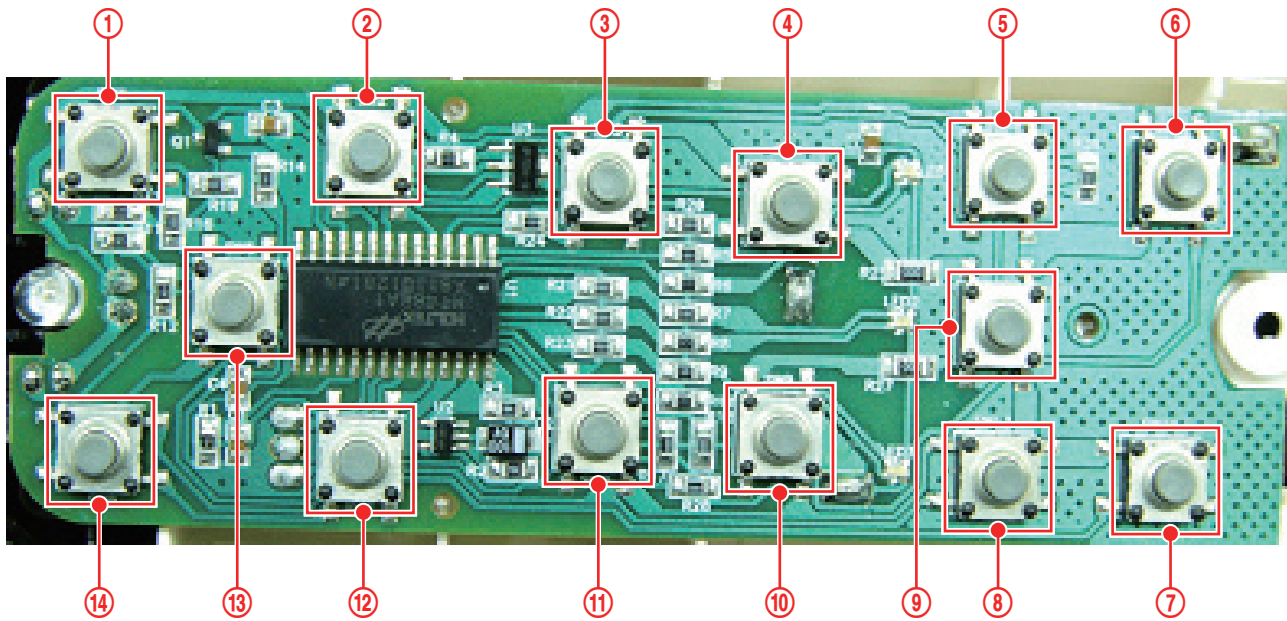

- ① SW1: Front Cleansing
- ② SW2: Dry
- ③ SW3: Nozzle Position Up
- ④ SW4: Nozzle Position Down
- ⑤ SW10: Water Temp.
- ⑥ SW12: Deodorize
- ⑦ SW14: Sterilize
- ⑧ SW13: Seat Temp.
- ⑨ SW11: Wide
- ⑩ SW9: Water Pres. / Dry Temp. Down
- ⑪ SW9: Water Pres. / Dry Temp. Up
- ⑫ SW7: Move
- ⑬ SW5: Stop
- ⑭ SW6: Rear Cleansing

MEMO

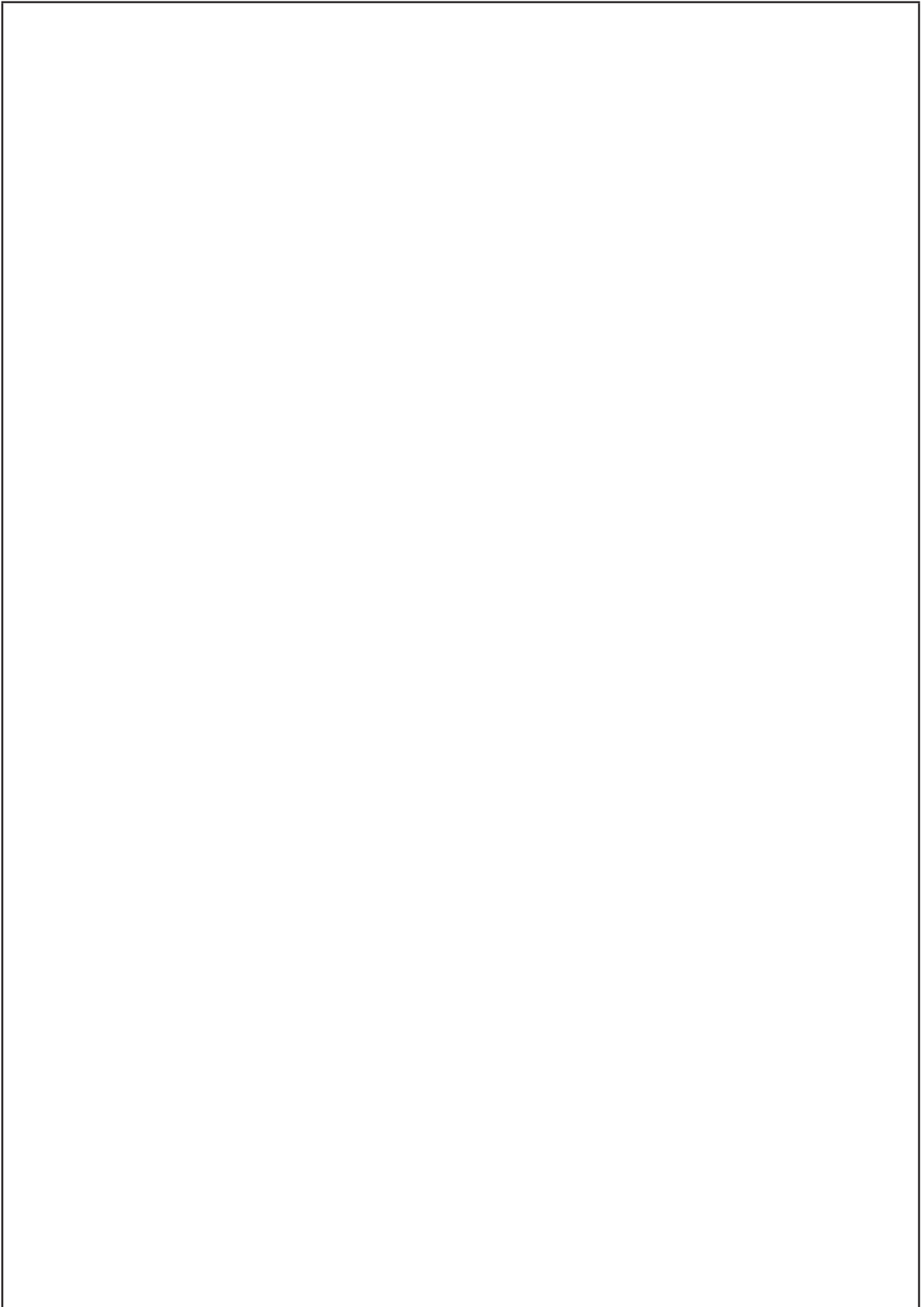
A large, empty rectangular box with a thin black border, occupying most of the page. It is intended for the user to write the content of their memo.

8. Reference information

8-1 Names of each part

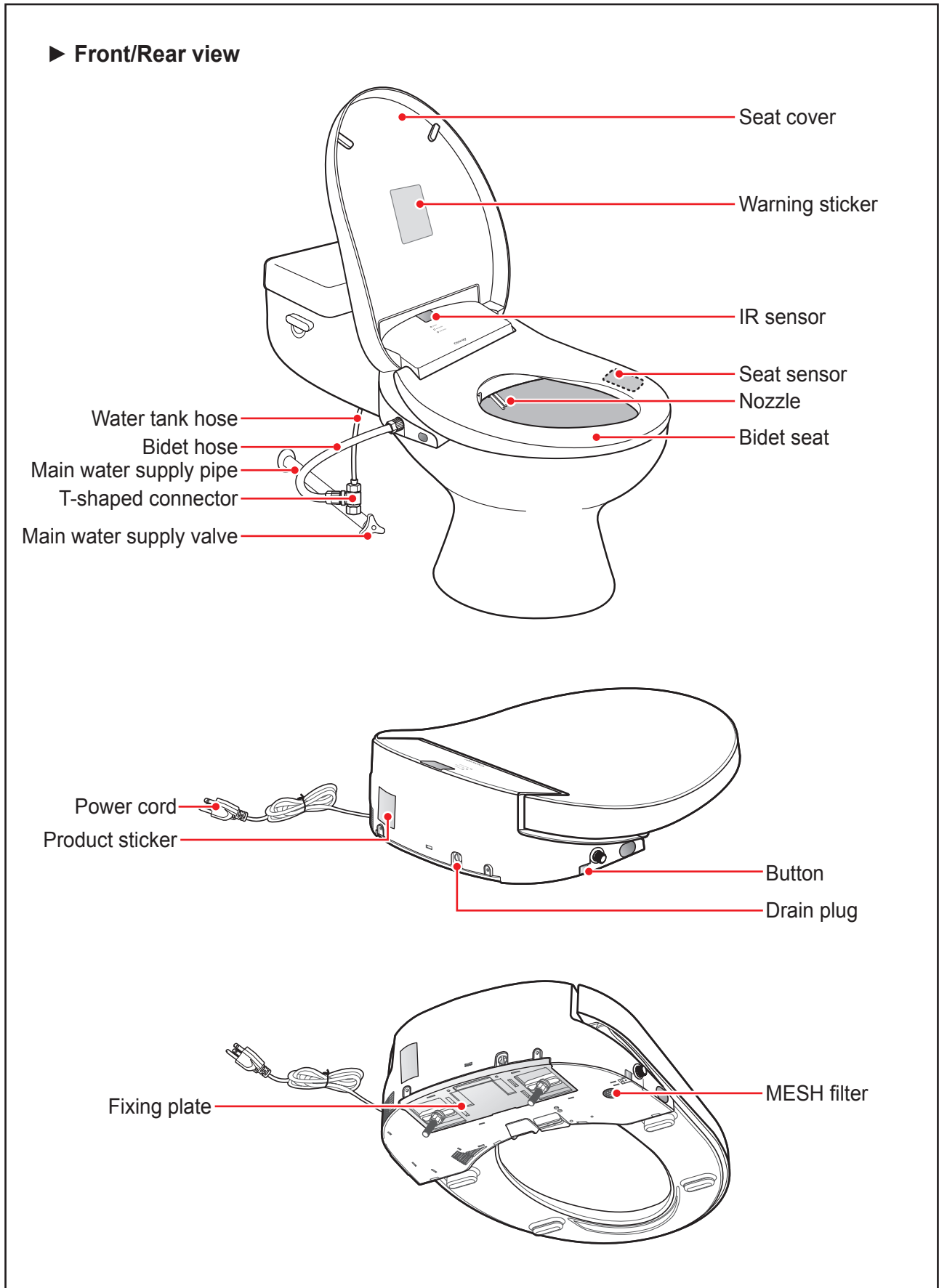

► Remote control

BA13-AR/AE

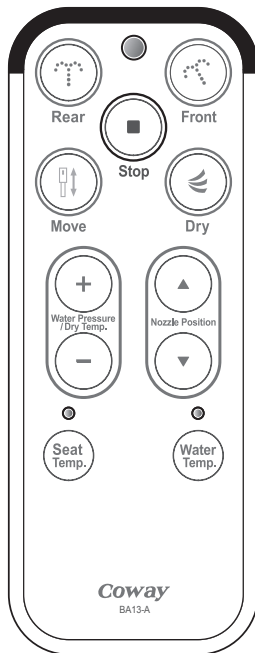

BA13-BR/BE

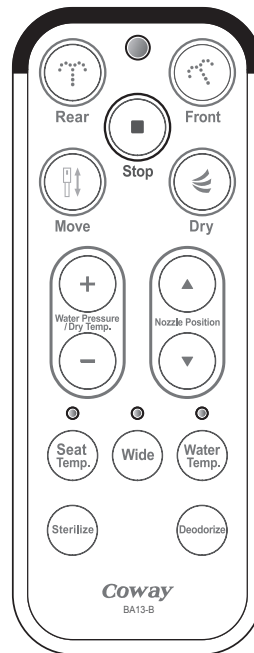



8-2 Functions and reference information

8-2-1 Explanation of indication and operation parts

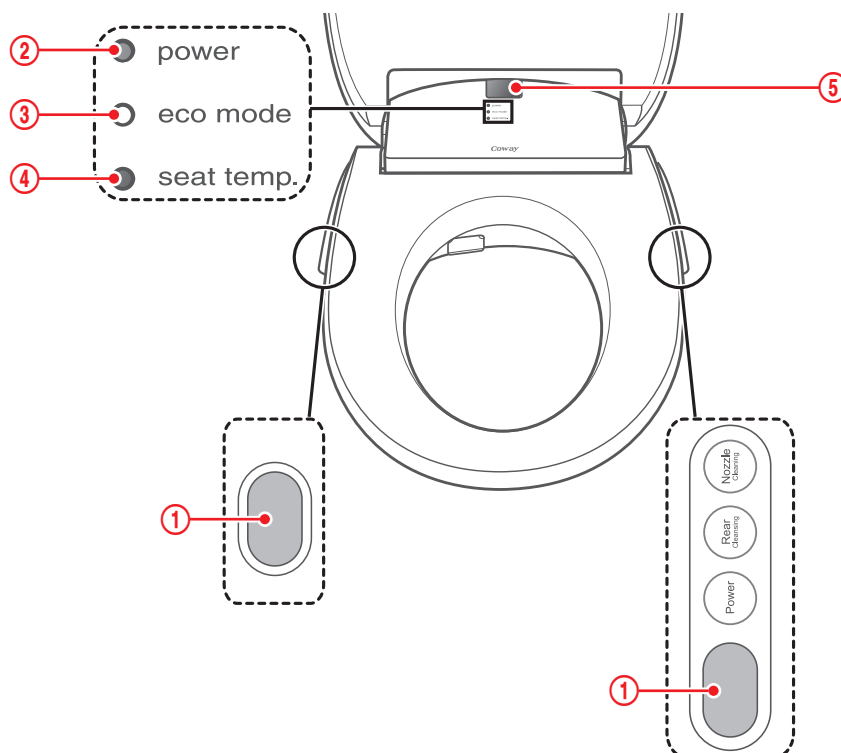

■ Indication Part

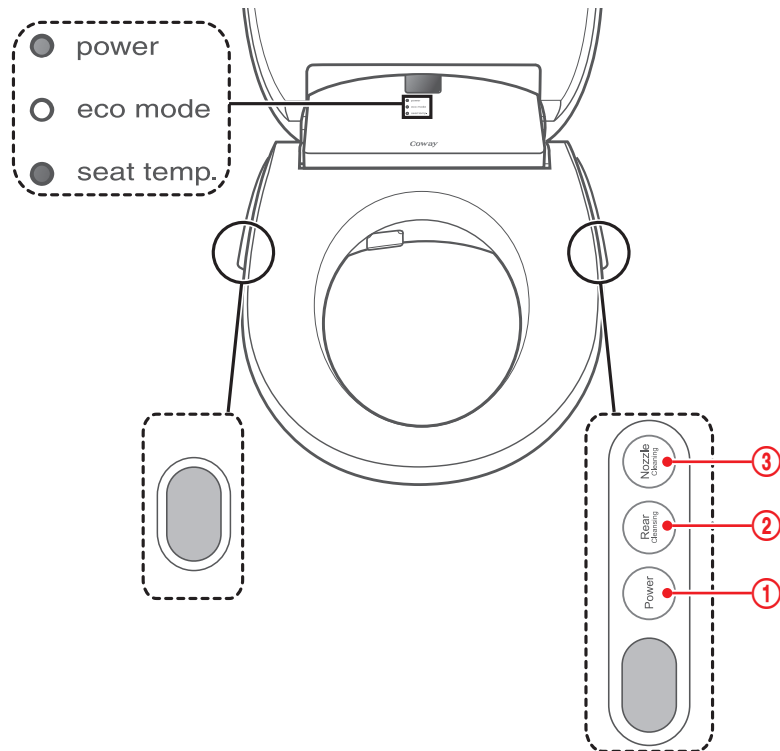

No.	Indication Part	Name	Explanation
①		Remote control signal receiver	This receives the signals from the remote control.
②	● power	Power indicator	This indicator is turned on when the bidet power is turned on. ※ This indicator is turned off when bidet eco mode is activated.
③	○ eco mode	Eco mode indicator	If you activate the eco function, this indicator is turned on when eco mode starts.
④	● seat temp.	Seat Temperature indicator	This indicator represents the seat temperature. Indicator on - L/M/H Indicator off - OFF ※ This indicator is turned off when bidet eco mode is activated.
⑤		Remote control signal receiver	This receives the signals from the remote control.

■ Operation Part



No.	Operation Part	Name	Explanation
①		Power button	Turns the product ON/OFF. Press and hold the button for more than 2 seconds when you turn it off. ※ If the Power button is pressed while the front, rear cleansing function is operating, the cleansing function is stopped and the bidet changes to standby mode.
②		Rear Cleansing button	Selects the rear cleansing function.
③		The Nozzle Cleaning button	Cleans the nozzle. If you press nozzle cleaning button, the nozzle is extended fully, and you can clean it conveniently.

8-2-2 Remote control explanation of indication and operation parts

■ Indication Part

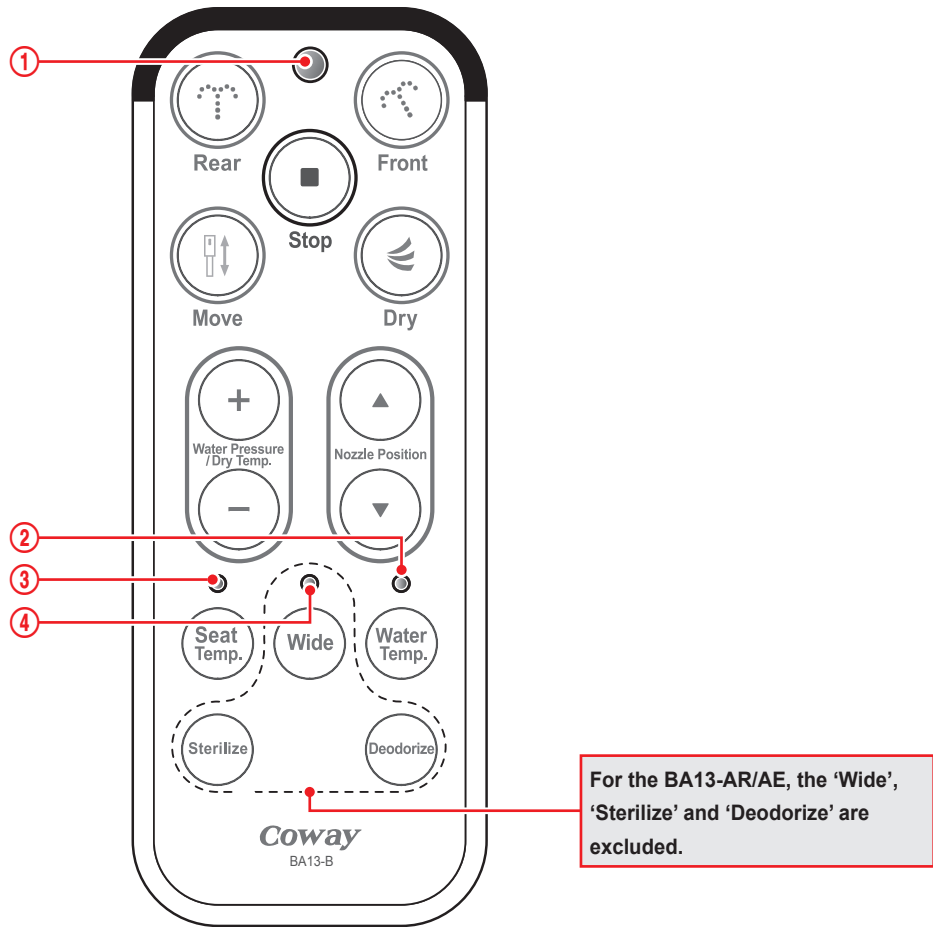





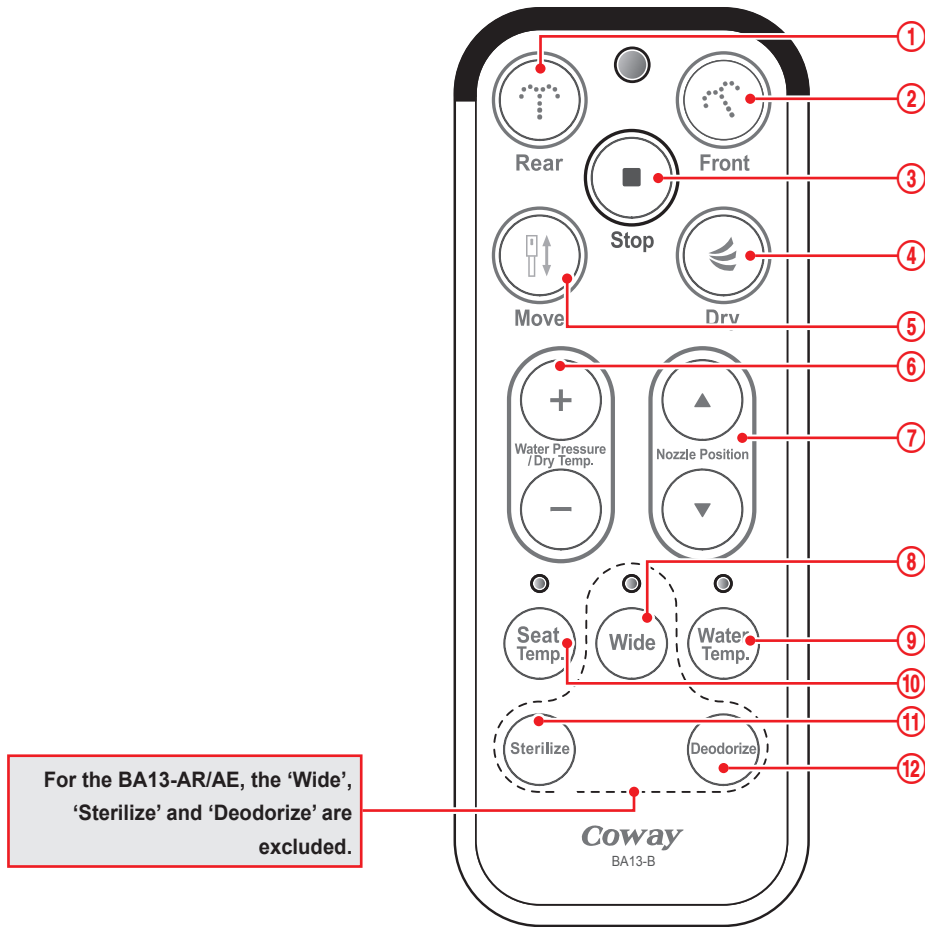





No.	Indication Part	Name	Explanation
①		Remote control signal transmitter	Transmits the signal when a remote control button is pressed.
②		Water temperature indicator	Whenever the Water Temp. button is pressed, the temperature control indicator cycles through the following order: L (Blue) → M (Pink) → H (Red) → Off.
③		Seat temperature indicator	Whenever the Seat Temp. button is pressed, the temperature control indicator cycles through the following options: L (Blue) → M (Pink) → H (Red) → Off.
④		Wide function indicator	Whenever the Wide button is pressed, the indicator cycles through the following options: Straight line (Blue) → Level 1 (Pink) → Level 2 (Red). ※ For the BA13-BR/BE only

■ Operation Part

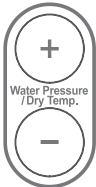

For the BA13-AR/AE, the 'Wide', 'Sterilize' and 'Deodorize' are excluded.

No.	Operation Part	Name	Explanation
①	 Rear	Rear cleansing button	Use this button to use the rear cleansing function.
②	 Front	Front cleansing button	Use this button to use the front cleansing function for women.
③	 Stop	Stop button	All currently operating functions will stop.
④	 Dry	Drying button	Use this button to use the drying function. It helps the drying process after using the rear cleansing/front cleansing function.

No.	Operation Part	Name	Explanation
⑤		Move button	Use this button to use the move function. If you press the Move button, as the nozzle is moved back and forth while you operate the rear cleansing/front cleansing function, you can clean a wider area.
⑥		Water Pressure/Drying Temperature button	You can control the water pressure in 3 levels and control the air dryer temperature in 4 levels using the Water Pressure/Drying Temperature control button. ※ You can control the water pressure when operating the rear cleansing/front cleansing functions and control the air dryer temperature when operating the drying function.
⑦		Nozzle Position button	Use this button to control the nozzle position during the rear cleansing/front cleansing operation. You can move the nozzle in 5 levels using the Nozzle Position button.
⑧		Wide function button	Use this button to control the water ejection range when using the cleansing function. You can select the angle of the water in 3 levels using the Wide function button (Straight Line → Level 1 → Level 2). Whenever this button is pressed, the Wide function indicator turns a different color. ※ For the BA13-BR/BE only
⑨		Water temperature button	Use this button to control the water temperature. Whenever the water temperature control button is pressed, you can control the water temperature in the following order: L → M → H → Off.
⑩		Seat temperature button	Use this button to control the seat temperature. Whenever the seat temperature control button is pressed, the seat temperature cycles through the following options: L → M → H → Off.
⑪		Sterilization button	Use this button to perform the sterilization function. Sterilizing water is ejected for 30 seconds to sterilize and clean the nozzle. ※ For the BA13-BR/BE only
⑫		Deodorization button	Use this button to perform the deodorization function. When you press this button, the deodorization function is performed for approximately 1 minute. ※ For the BA13-BR/BE only

8-2-3 Using the rear nozzle

■ Using the rear nozzle

1. Sit down on the seat and press the 'Rear cleansing' button on the operation part.
2. Self-cleansing for the rear cleansing nozzle is performed, removing the cold water remaining inside the nozzle before the water stream is ejected so that the water can be set to a desired temperature for cleansing.
 - ※ The cleansing water ejection time may be delayed while the above functions are performed.
3. The cleansing water is ejected for approximately 1 minute and then stops automatically.
4. Automatic nozzle cleaning is performed for approximately 5 seconds after rear cleansing. Then the nozzle retracts itself.
5. You can adjust the nozzle position by pressing the 'Nozzle Position' button.
6. You can adjust the water ejection angle by pressing the 'Wide' button (for the BA13-BR/BE only).
 - ※ If the 'Rear cleansing' button is pressed again during the cleansing operation, the rear cleansing function operates for another 1 minute.
 - ※ While cleansing, users can adjust the water temperature, water pressure, and nozzle position according to their preferences.
 - ※ You can not increase the water pressure level higher than level 2 if your area is in the following conditions.
 - Main water supply temperature under 10 °C and rated power source under 110 V~.
 - ※ If the seat sensor does not detect a human body, the bidet will not work.

■ Moving

1. Press the 'Move' button on the operation part.
 - The nozzle moves back and forth, providing a wider range of cleansing.
 - ※ This will operate for as long as the rear cleansing function continues.
 - ※ You can control the nozzle position by pressing the 'Nozzle Position' button.
 - ※ To stop the move function, press the 'Move' button once again.

■ Drying

1. Press the 'Dry' button on the operation part.
 - Warm air is emitted for approximately 2 minutes.
 - ※ If you wipe off the water lightly before turning on the air dryer, drying will finish faster.
 - ※ You can control the air temperature by pressing the 'Dry Temp.' button.
 - ※ If you press the 'Dry' button again during the operation, additional drying starts for another 2 minutes.
 - ※ If you press the 'Dry' button while cleansing, cleansing is stopped and drying starts immediately.

■ Stopping

1. To stop the current operation, press the 'Stop' button.
 - This stops all currently operating functions.
 - ※ The drying function stops 2 seconds after the 'Stop' button is pressed.

8-2-4 Using the front nozzle

■ Using the front nozzle

1. Sit down on the seat and press the 'Front cleansing' button on the operation part.
2. Self-cleansing for the front cleansing nozzle is performed, removing the cold water remaining inside the nozzle before the water stream is ejected so that the water can be set to a desired temperature for cleansing.
 - ※ The cleansing water ejection time may be delayed while the above functions are performed.
3. The cleansing water is ejected for approximately 1 minute and then stops automatically.
4. Automatic nozzle cleaning is performed for approximately 5 seconds after front cleansing. Then the nozzle retracts itself.
5. You can adjust the nozzle position by pressing the 'Nozzle Position' button.
6. You can adjust the water ejection angle by pressing the 'Wide' button (for the BA13-BR/BE only).
 - ※ If the 'Front cleansing' button is pressed again during the cleansing operation, the front cleansing function operates for another 1 minute.
 - ※ While cleansing, users can adjust the water temperature, water pressure, and nozzle position according to their preferences.
 - ※ You can not increase the water pressure level higher than level 2 if your area is in the following conditions.
 - Main water supply temperature under 10 °C and rated power source under 110 V~ .
 - ※ If the seat sensor does not detect a human body, the bidet will not work.

■ Moving

1. Press the 'Move' button on the operation part.
 - The nozzle moves back and forth, providing a wider range of cleansing.
 - ※ This will operate for as long as the front cleansing function continues.
 - ※ You can control the nozzle position by pressing the 'Nozzle Position' button.
 - ※ To stop the move function, press the 'Move' button again.

■ Drying

1. Press the 'Dry' button on the operation part.
 - Warm air is emitted for approximately 2 minutes.
 - ※ If you wipe off the water lightly before turning on the air dryer, drying will finish faster.
 - ※ You can control the air temperature by pressing the 'Dry Temp.' button.
 - ※ If you press the 'Dry' button again during the operation, additional drying starts for another 2 minutes.
 - ※ if you press the 'Dry' button while cleansing, cleansing is stopped and drying starts immediately.

■ Stopping

1. To stop the current operation, press the 'Stop' button.
 - This stops all currently operating functions.
 - ※ The drying function stops 2 seconds after the 'Stop' button is pressed.

8-2-5 Function specifications

Function	Classification	Detailed Operation		
The bell for each state	General Operation	<ul style="list-style-type: none"> ▶ Power On: 2 Khz 120 ms ▶ Power Off: 2 Khz 120 ms → Wait for 280 ms → 2 Khz 120 ms ▶ Pressing a remote control button: 2Khz 120ms 		
	Configuration Mode	<ul style="list-style-type: none"> ▶ When a function is set: 2 Khz 220 ms → 1 Khz 220 ms ▶ When a function is canceled: 2 Khz 100 ms → 1 Khz 100 ms → 2 Khz 280 ms ▶ When configuration is complete: 2 Khz 220 ms → 1 Khz 220 ms 		
	Error Code	Description	Detection Frequency	Progress after the error
1	The temperature of the sprayed water does not change even if the temperature setting is changed.	7 secs or longer	An error sound is generated and the Seat LED blinks. The error is cleared when a remote control button is pressed.	
2	When the amount of water is detected as 150 or lower.	200 ms or longer	Insert the nozzle and wait. The bell rings once. No LED indication.	
3	When the seat temperature sensor detects a temperature of 51 °C or higher (when the flow rate sensor is working.)	2 secs or longer	An error sound is generated and the Seat and Power-Saving LEDs blink.	
4	This occurs when the feed water temperature (T1) is 41 °C or higher.	2 secs or longer	The error sound is generated and the Power LED blinks.	
	This occurs when the feed water temperature (T2) is 45 °C or higher.	100 ms or longer	An error sound is generated and the Power LED blinks. Self-cleansing is performed after 10 seconds. When the feed water temperature difference is 5 °C or less, the error is cleared.	

Function	Classification	Detailed Operation					
The bell for each state	Error Code	Description		Detection Frequency	Progress after the error		
	5	Voltage	120 V	When the voltage is 87 V or lower, or 150 V or higher	Detects 3 seconds after the power is turned on. 2 secs or longer (± 5 V)	This is automatically restored when the power voltage changes to normal. The error is cleared 10 seconds after the voltage restoration.	LED: The Power and Seat LEDs blink.
			240 V	When the voltage is 190 V or lower, or 290 V or higher			
		Frequency	60 Hz	When the frequency is 55 Hz or lower, or 65 Hz or higher	Detects 3 seconds after the power is turned on. 2 secs or longer (± 1 Hz)	An error sound is generated and the LED blinks.	
50 Hz	When the frequency is 45 Hz or lower, or 55 Hz or higher						
6	An open-circuit or short-circuit of the temperature sensors T1, T2, or the seat temperature sensor is detected.		This is detected for 100 ms or longer	An error sound is generated and the Power and Power-Saving LEDs blink.			

Function	Classification	Detailed Operation																														
Power Signal Input	Initial Operation (Power)	1) The Power LED is lit and then the unit changes to Standby mode.																														
	Power Off	1) The Power button is pressed when power is supplied (when the Power button is pressed and held for at least 2 seconds.) 2) The unit waits for input (waits for a main input.)																														
	Stopping	▶ It stops when the rear cleansing, front-cleansing or deodorization operation is performed. - If the Power button is pressed when the power is supplied, the Stop command is performed.																														
<table border="1"> <thead> <tr> <th>Item</th> <th>Setting</th> <th>Remarks</th> </tr> </thead> <tbody> <tr> <td>Power</td> <td>OFF</td> <td>When the Power ON command is input, the power is turned on.</td> </tr> <tr> <td>Water Pressure</td> <td>Step 1</td> <td></td> </tr> <tr> <td>Nozzle Position</td> <td>Standard (Step 3)</td> <td></td> </tr> <tr> <td>Dryer Temperature</td> <td>Step 1 (OFF)</td> <td></td> </tr> <tr> <td>Water Temperature</td> <td>OFF</td> <td></td> </tr> <tr> <td>Seat Temperature</td> <td>OFF</td> <td></td> </tr> <tr> <td>Flow Rate Sensor</td> <td>OFF</td> <td>Power On → Flow Rate Sensor ON</td> </tr> <tr> <td>Zero_Con</td> <td>OFF</td> <td>Power On → Zero Con ON (when no additional button is pressed.)</td> </tr> <tr> <td>ID Setting</td> <td></td> <td>The configured setting is applied.</td> </tr> </tbody> </table>			Item	Setting	Remarks	Power	OFF	When the Power ON command is input, the power is turned on.	Water Pressure	Step 1		Nozzle Position	Standard (Step 3)		Dryer Temperature	Step 1 (OFF)		Water Temperature	OFF		Seat Temperature	OFF		Flow Rate Sensor	OFF	Power On → Flow Rate Sensor ON	Zero_Con	OFF	Power On → Zero Con ON (when no additional button is pressed.)	ID Setting		The configured setting is applied.
Item	Setting	Remarks																														
Power	OFF	When the Power ON command is input, the power is turned on.																														
Water Pressure	Step 1																															
Nozzle Position	Standard (Step 3)																															
Dryer Temperature	Step 1 (OFF)																															
Water Temperature	OFF																															
Seat Temperature	OFF																															
Flow Rate Sensor	OFF	Power On → Flow Rate Sensor ON																														
Zero_Con	OFF	Power On → Zero Con ON (when no additional button is pressed.)																														
ID Setting		The configured setting is applied.																														

Function	Classification	Detailed Operation
Rear Cleaning	Operation	<ul style="list-style-type: none"> ▶ Rear cleansing begins when the main body or remote control “Rear Cleansing” button. ▶ If the Rear Cleansing button is pressed while another function is working, the current function is canceled and the Rear Cleansing operation is performed. (However, it will not work during the sterilization or nozzle cleansing operation.) <ol style="list-style-type: none"> 1) 4-way cleansing (470 pulse) is performed in the 2-way self-cleansing position (0 pulse). 2) The feed water valve is On 3) Temperature Step 1: 29 °C, Temperature Step 2/3: 2-Way self-cleansing is performed when the temperature of the sprayed water reaches 29.5 °C. 4) The nozzle moves to the configured position. 5) The 2-way water pressure setting is restored. 6) Water is sprayed for 60 seconds when no key is pressed – The air pump runs. 7) When the rear cleansing operation is complete, the nozzle moves to the 2-way self-cleansing position (0 pulse). (The heater is off when hot water is selected.) 8) The move motor moves to the waiting position. 9) Self-cleansing is performed. 10) When self-cleansing is complete, the unit waits for input (waits for remote control or main button input.)

Function	Classification	Detailed Operation																														
Rear Cleaning	Stopping	<p>▶ The heater control is turned off when the “Stop”, “Front Cleansing” or “Dry” signal is input or after the cleansing operation has been performed for 1 minute. Moves to the 2-way self-cleansing position.</p> <p>1) Self-cleansing is performed.</p> <p>2) When self-cleansing is complete, the unit waits for input (waits for remote control or main button input.)</p>																														
		<table border="1"> <thead> <tr> <th>Item</th> <th>Setting</th> <th>Remarks</th> </tr> </thead> <tbody> <tr> <td>Power</td> <td>ON</td> <td>When the Power ON command is input, the power is turned on.</td> </tr> <tr> <td>Water Pressure</td> <td>-</td> <td>The configured setting is applied.</td> </tr> <tr> <td>Nozzle Position</td> <td>Standard (Step 3)</td> <td>The configured setting is applied.</td> </tr> <tr> <td>Dryer Temperature</td> <td>OFF</td> <td>OFF</td> </tr> <tr> <td>Water Temperature</td> <td>-</td> <td>The configured setting is applied.</td> </tr> <tr> <td>Seat Temperature</td> <td>-</td> <td>The configured setting is applied.</td> </tr> <tr> <td>Flow Rate Sensor</td> <td>ON</td> <td>The Flow Rate Sensor is ON</td> </tr> <tr> <td>Zero_Con</td> <td>ON</td> <td>Zero Con is turned off 30 minutes after the seat cover is turned OFF when Zero Con is on (when there is no additional button input).</td> </tr> <tr> <td>ID Setting</td> <td></td> <td>The configured setting is applied.</td> </tr> </tbody> </table>	Item	Setting	Remarks	Power	ON	When the Power ON command is input, the power is turned on.	Water Pressure	-	The configured setting is applied.	Nozzle Position	Standard (Step 3)	The configured setting is applied.	Dryer Temperature	OFF	OFF	Water Temperature	-	The configured setting is applied.	Seat Temperature	-	The configured setting is applied.	Flow Rate Sensor	ON	The Flow Rate Sensor is ON	Zero_Con	ON	Zero Con is turned off 30 minutes after the seat cover is turned OFF when Zero Con is on (when there is no additional button input).	ID Setting		The configured setting is applied.
	Item	Setting	Remarks																													
	Power	ON	When the Power ON command is input, the power is turned on.																													
	Water Pressure	-	The configured setting is applied.																													
	Nozzle Position	Standard (Step 3)	The configured setting is applied.																													
	Dryer Temperature	OFF	OFF																													
	Water Temperature	-	The configured setting is applied.																													
	Seat Temperature	-	The configured setting is applied.																													
	Flow Rate Sensor	ON	The Flow Rate Sensor is ON																													
Zero_Con	ON	Zero Con is turned off 30 minutes after the seat cover is turned OFF when Zero Con is on (when there is no additional button input).																														
ID Setting		The configured setting is applied.																														

Function	Classification	Detailed Operation
Front Cleansing	Operation	<ul style="list-style-type: none"> ▶ Front cleansing begins when the main body or remote control “Front Cleansing” button is pressed. ▶ If the Front Cleansing button is pressed while another function is working, the current function is canceled and the front cleansing operation is performed. (However, it will not work during the sterilization or nozzle cleansing operation.) ▶ “Front Cleansing” during a function operation <ol style="list-style-type: none"> 1) 4-Way bidet (1420 pulse) is performed in a 2-way self-cleansing position (0 pulse) 2) The feed water valve is On 3) Temperature Step 1: 29 °C, Temperature Step 2/3: 2-Way self-cleansing is performed when the temperature of the sprayed water reaches 29.5 °C. 4) The nozzle moves to the configured position. 5) The 2-way water pressure setting is restored. 6) Water is sprayed for 60 seconds when no key is pressed – The air pump runs. 7) When the front cleansing operation is complete, the nozzle moves to the 2-way self-cleansing position (0 pulse). (The heater is off when hot water is set.) 8) The move motor moves to the waiting position. 9) Self-cleansing is performed. 10) When self-cleansing is complete, the unit waits for input (Waits for remote control or main button input.)

Function	Classification	Detailed Operation		
Front Cleansing	Stopping	<p>▶ The heater control is turned off when “Stop”, “Front Cleansing” or “Dry” signal is input or after 1 minute of the cleansing operation. Moves to the 2-way self-cleansing position.</p> <p>1) Self-cleansing is performed. 2) When the self-cleansing is complete, the unit waits for input (waits for remote control or main button input.)</p>		
		Item	Setting	Remarks
		Power	ON	When the Power ON command is input, the power is turned on.
		Water Pressure	-	The configured setting is applied.
		Nozzle Position	Standard (Step 3)	The configured setting is applied.
		Dryer Temperature	OFF	OFF
		Water Temperature	-	The configured setting is applied.
		Seat Temperature	-	The configured setting is applied.
		Flow Rate Sensor	ON	Flow Rate Sensor ON
		Zero_Con	ON	Zero Con ON
		ID Setting		The configured setting is applied.

Function	Classification	Detailed Operation																														
Drying	Operation	<ul style="list-style-type: none"> ▶ Drying begins when the “Dry” remote control button is pressed. ▶ If the Drying function is selected when another function is in operation, the current function is canceled and the air dryer starts. (This does not work when deodorization is stopped or during the sterilization or nozzle cleansing operation.) ※ If deodorization was in progress, deodorization is stopped → the deodorization operates for the remaining time after the drying operation is completed. 1) If a temperature button is pressed, the unit controls the drying heater with the corresponding value. (This turns the heater off or sets the heater operation level to 50 %, 70 % or 90 %) 2) It stops after 2 minutes of operation. 																														
	Stopping	<ul style="list-style-type: none"> ▶ If the “Stop” remote control button is pressed, the dryer fan stops 2 seconds after turning the heater off. ▶ If the “Stop” main body button is pressed, the dryer fan stops 2 seconds after turning the heater off. ▶ When 2 minutes of drying time have passed, the drying fan stops 2 seconds after turning the heater off, and waits for input. ▶ If the dryer temperature is not set, the fan stops immediately when the “Stop” button is pressed. 																														
<table border="1"> <thead> <tr> <th>Item</th> <th>Setting</th> <th>Remarks</th> </tr> </thead> <tbody> <tr> <td>Power</td> <td>ON</td> <td>When the Power ON command is input, the power is turned on.</td> </tr> <tr> <td>Water Pressure</td> <td>-</td> <td>OFF</td> </tr> <tr> <td>Nozzle Position</td> <td>-</td> <td>The nozzle moves to its original position.</td> </tr> <tr> <td>Dryer Temperature</td> <td>-</td> <td>The configured setting is applied.</td> </tr> <tr> <td>Water Temperature</td> <td>-</td> <td>The configured setting is applied.</td> </tr> <tr> <td>Seat Temperature</td> <td>-</td> <td>The configured setting is applied.</td> </tr> <tr> <td>Flow Rate Sensor</td> <td>ON</td> <td>Flow Rate Sensor ON</td> </tr> <tr> <td>Zero_Con</td> <td>ON</td> <td>Zero Con ON</td> </tr> <tr> <td>ID Setting</td> <td></td> <td>The configured setting is applied.</td> </tr> </tbody> </table>			Item	Setting	Remarks	Power	ON	When the Power ON command is input, the power is turned on.	Water Pressure	-	OFF	Nozzle Position	-	The nozzle moves to its original position.	Dryer Temperature	-	The configured setting is applied.	Water Temperature	-	The configured setting is applied.	Seat Temperature	-	The configured setting is applied.	Flow Rate Sensor	ON	Flow Rate Sensor ON	Zero_Con	ON	Zero Con ON	ID Setting		The configured setting is applied.
Item	Setting	Remarks																														
Power	ON	When the Power ON command is input, the power is turned on.																														
Water Pressure	-	OFF																														
Nozzle Position	-	The nozzle moves to its original position.																														
Dryer Temperature	-	The configured setting is applied.																														
Water Temperature	-	The configured setting is applied.																														
Seat Temperature	-	The configured setting is applied.																														
Flow Rate Sensor	ON	Flow Rate Sensor ON																														
Zero_Con	ON	Zero Con ON																														
ID Setting		The configured setting is applied.																														

Function	Classification	Detailed Operation																														
Self-Cleansing	Operation	<p>▶ After completing a rear cleansing/ front cleansing operation.</p> <ol style="list-style-type: none"> 1) The feed water valve is turned On 2) The 4-way original position (0 pulse) from the 2-way self-cleansing position (0 pulse), moves the nozzle to the original position (960 pulse) and turns the heater off. 3) The difference between T2 and T1 of the configured temperature is less than 5 °C. (3 seconds by default. Error 4 occurs when the difference is not less than 5 °C within 1 minute.) 4) The feed water valve is Off 5) Drives the air pump for approximately 3 seconds (to remove the remaining water.) 6) The unit waits for input (waits for a remote control or main button input.) 																														
		<table border="1"> <thead> <tr> <th>Item</th> <th>Setting</th> <th>Remarks</th> </tr> </thead> <tbody> <tr> <td>Power</td> <td>ON</td> <td>When the Power ON command is input, the power is turned on.</td> </tr> <tr> <td>Water Pressure</td> <td>-</td> <td>The configured setting is applied.</td> </tr> <tr> <td>Nozzle Position</td> <td>Standard (Step 3)</td> <td>The configured setting is applied.</td> </tr> <tr> <td>Dryer Temperature</td> <td>-</td> <td>The configured setting is applied.</td> </tr> <tr> <td>Water Temperature</td> <td>-</td> <td>The configured setting is applied.</td> </tr> <tr> <td>Seat Temperature</td> <td>-</td> <td>The configured setting is applied.</td> </tr> <tr> <td>Flow Rate Sensor</td> <td>ON</td> <td>Flow Rate Sensor ON</td> </tr> <tr> <td>Zero_Con</td> <td>ON</td> <td>Zero Con ON</td> </tr> <tr> <td>ID Setting</td> <td></td> <td>The configured setting is applied.</td> </tr> </tbody> </table>	Item	Setting	Remarks	Power	ON	When the Power ON command is input, the power is turned on.	Water Pressure	-	The configured setting is applied.	Nozzle Position	Standard (Step 3)	The configured setting is applied.	Dryer Temperature	-	The configured setting is applied.	Water Temperature	-	The configured setting is applied.	Seat Temperature	-	The configured setting is applied.	Flow Rate Sensor	ON	Flow Rate Sensor ON	Zero_Con	ON	Zero Con ON	ID Setting		The configured setting is applied.
		Item	Setting	Remarks																												
		Power	ON	When the Power ON command is input, the power is turned on.																												
		Water Pressure	-	The configured setting is applied.																												
		Nozzle Position	Standard (Step 3)	The configured setting is applied.																												
		Dryer Temperature	-	The configured setting is applied.																												
		Water Temperature	-	The configured setting is applied.																												
		Seat Temperature	-	The configured setting is applied.																												
		Flow Rate Sensor	ON	Flow Rate Sensor ON																												
Zero_Con	ON	Zero Con ON																														
ID Setting		The configured setting is applied.																														

Function	Classification	Detailed Operation																																
Water pressure control	Operation	<p>▶ The water pressure can be controlled in 3 steps with the remote control Water Pressure button (for front and rear cleansing)</p> <table border="1"> <thead> <tr> <th>Water pressure control</th> <th>Step 1</th> <th>Step 2</th> <th>Step 3</th> </tr> </thead> <tbody> <tr> <td>The flow rate of the nozzle \pm 50 cc</td> <td>350 cc</td> <td>420 cc</td> <td>500 cc</td> </tr> <tr> <td>Pump Voltage \pm 1.5 V</td> <td>15 V</td> <td>20 V</td> <td>23 V</td> </tr> </tbody> </table> <p>※ When the temperature of the sprayed water during the initial spray (preliminary heating) is equal to or lower than 10 °C and the voltage is equal to or lower than 110 V and they are detected for 1 second at the same time, the pressure for the water spray is controlled in 2 steps.</p> <p>※ If the water pressure setting changes, the valve is set to the corresponding flow rate within 4 seconds of the voltage changing.</p>	Water pressure control	Step 1	Step 2	Step 3	The flow rate of the nozzle \pm 50 cc	350 cc	420 cc	500 cc	Pump Voltage \pm 1.5 V	15 V	20 V	23 V																				
		Water pressure control	Step 1	Step 2	Step 3																													
		The flow rate of the nozzle \pm 50 cc	350 cc	420 cc	500 cc																													
		Pump Voltage \pm 1.5 V	15 V	20 V	23 V																													
				<table border="1"> <thead> <tr> <th>Item</th> <th>Setting</th> <th>Remarks</th> </tr> </thead> <tbody> <tr> <td>Power</td> <td>ON</td> <td>When the Power ON command is input, the power is turned on.</td> </tr> <tr> <td>Water Pressure</td> <td>-</td> <td>The configured setting is applied.</td> </tr> <tr> <td>Nozzle Position</td> <td>Standard (Step 3)</td> <td>The configured setting is applied.</td> </tr> <tr> <td>Dryer Temperature</td> <td>-</td> <td>The configured setting is applied.</td> </tr> <tr> <td>Water Temperature</td> <td>-</td> <td>The configured setting is applied.</td> </tr> <tr> <td>Seat Temperature</td> <td>-</td> <td>The configured setting is applied.</td> </tr> <tr> <td>Flow Rate Sensor</td> <td>ON</td> <td>Flow Rate Sensor ON</td> </tr> <tr> <td>Zero_Con</td> <td>ON</td> <td>Zero Con ON</td> </tr> <tr> <td>ID Setting</td> <td></td> <td>The configured setting is applied.</td> </tr> </tbody> </table>	Item	Setting	Remarks	Power	ON	When the Power ON command is input, the power is turned on.	Water Pressure	-	The configured setting is applied.	Nozzle Position	Standard (Step 3)	The configured setting is applied.	Dryer Temperature	-	The configured setting is applied.	Water Temperature	-	The configured setting is applied.	Seat Temperature	-	The configured setting is applied.	Flow Rate Sensor	ON	Flow Rate Sensor ON	Zero_Con	ON	Zero Con ON	ID Setting		The configured setting is applied.
		Item	Setting	Remarks																														
		Power	ON	When the Power ON command is input, the power is turned on.																														
		Water Pressure	-	The configured setting is applied.																														
		Nozzle Position	Standard (Step 3)	The configured setting is applied.																														
		Dryer Temperature	-	The configured setting is applied.																														
Water Temperature	-	The configured setting is applied.																																
Seat Temperature	-	The configured setting is applied.																																
Flow Rate Sensor	ON	Flow Rate Sensor ON																																
Zero_Con	ON	Zero Con ON																																
ID Setting		The configured setting is applied.																																

Function	Classification	Detailed Operation																																			
Nozzle Position	Operation	<ul style="list-style-type: none"> ▶ This can be operated by the remote control Nozzle Position button (in 5 steps) during the front or rear cleansing operation. ▶ Control in steps according to the nozzle position setting 																																			
		Setting		Step 1	Step 2	Step 3	Step 4	Step 5																													
		Movement Distance		Approximately 5 mm movement for each step																																	
		<table border="1" style="width: 100%; border-collapse: collapse;"> <thead> <tr> <th style="width: 25%;">Item</th> <th style="width: 20%;">Setting</th> <th style="width: 55%;">Remarks</th> </tr> </thead> <tbody> <tr> <td>Power</td> <td>ON</td> <td>When the Power ON command is input, the power is turned on.</td> </tr> <tr> <td>Water Pressure</td> <td>-</td> <td>The configured setting is applied.</td> </tr> <tr> <td>Nozzle Position</td> <td>Standard (Step 3)</td> <td>The configured setting is applied.</td> </tr> <tr> <td>Dryer Temperature</td> <td></td> <td>The configured setting is applied.</td> </tr> <tr> <td>Water Temperature</td> <td></td> <td>The configured setting is applied.</td> </tr> <tr> <td>Seat Temperature</td> <td></td> <td>The configured setting is applied.</td> </tr> <tr> <td>Flow Rate Sensor</td> <td>ON</td> <td>Flow Rate Sensor ON</td> </tr> <tr> <td>Zero_Con</td> <td>ON</td> <td>Zero Con ON</td> </tr> <tr> <td>ID Setting</td> <td></td> <td>The configured setting is applied.</td> </tr> </tbody> </table>						Item	Setting	Remarks	Power	ON	When the Power ON command is input, the power is turned on.	Water Pressure	-	The configured setting is applied.	Nozzle Position	Standard (Step 3)	The configured setting is applied.	Dryer Temperature		The configured setting is applied.	Water Temperature		The configured setting is applied.	Seat Temperature		The configured setting is applied.	Flow Rate Sensor	ON	Flow Rate Sensor ON	Zero_Con	ON	Zero Con ON	ID Setting		The configured setting is applied.
Item	Setting	Remarks																																			
Power	ON	When the Power ON command is input, the power is turned on.																																			
Water Pressure	-	The configured setting is applied.																																			
Nozzle Position	Standard (Step 3)	The configured setting is applied.																																			
Dryer Temperature		The configured setting is applied.																																			
Water Temperature		The configured setting is applied.																																			
Seat Temperature		The configured setting is applied.																																			
Flow Rate Sensor	ON	Flow Rate Sensor ON																																			
Zero_Con	ON	Zero Con ON																																			
ID Setting		The configured setting is applied.																																			

Function	Classification	Detailed Operation																																				
Move	Operation	<p>▶ When the button is pressed (when front or rear cleansing is performed), the nozzle moves by +/- 5 mm (for each +/- 1 step). If the button is pressed again, this function is canceled.</p> <p>- After stopping the function, the movement function is canceled.</p>																																				
		<table border="1"> <thead> <tr> <th>Item</th> <th>Setting</th> <th>Remarks</th> </tr> </thead> <tbody> <tr> <td>Power</td> <td>ON</td> <td>When the Power ON command is input, the power is turned on.</td> </tr> <tr> <td>Water Pressure</td> <td>-</td> <td>The configured setting is applied.</td> </tr> <tr> <td>Nozzle Position</td> <td>-</td> <td>The configured setting is applied.</td> </tr> <tr> <td>Dryer Temperature</td> <td>-</td> <td>The configured setting is applied.</td> </tr> <tr> <td>Water Temperature</td> <td>-</td> <td>The configured setting is applied.</td> </tr> <tr> <td>Seat Temperature</td> <td>-</td> <td>The configured setting is applied.</td> </tr> <tr> <td>Seat Sensor Detection</td> <td>ON</td> <td>Nozzle cleansing is performed regardless of whether a user is seated.</td> </tr> <tr> <td>Flow Rate Sensor</td> <td>ON</td> <td>Flow Rate Sensor ON</td> </tr> <tr> <td>Zero_Con</td> <td>ON</td> <td>Zero Con ON</td> </tr> <tr> <td>ID Setting</td> <td></td> <td>The configured setting is applied.</td> </tr> <tr> <td>Water Pressure</td> <td>-</td> <td>The configured setting is applied.</td> </tr> </tbody> </table>	Item	Setting	Remarks	Power	ON	When the Power ON command is input, the power is turned on.	Water Pressure	-	The configured setting is applied.	Nozzle Position	-	The configured setting is applied.	Dryer Temperature	-	The configured setting is applied.	Water Temperature	-	The configured setting is applied.	Seat Temperature	-	The configured setting is applied.	Seat Sensor Detection	ON	Nozzle cleansing is performed regardless of whether a user is seated.	Flow Rate Sensor	ON	Flow Rate Sensor ON	Zero_Con	ON	Zero Con ON	ID Setting		The configured setting is applied.	Water Pressure	-	The configured setting is applied.
		Item	Setting	Remarks																																		
		Power	ON	When the Power ON command is input, the power is turned on.																																		
		Water Pressure	-	The configured setting is applied.																																		
		Nozzle Position	-	The configured setting is applied.																																		
		Dryer Temperature	-	The configured setting is applied.																																		
		Water Temperature	-	The configured setting is applied.																																		
		Seat Temperature	-	The configured setting is applied.																																		
		Seat Sensor Detection	ON	Nozzle cleansing is performed regardless of whether a user is seated.																																		
		Flow Rate Sensor	ON	Flow Rate Sensor ON																																		
		Zero_Con	ON	Zero Con ON																																		
		ID Setting		The configured setting is applied.																																		
Water Pressure	-	The configured setting is applied.																																				

Function	Classification	Detailed Operation		
Wide	Operation	▶ If the Wide button is pressed while front or rear cleansing is performed, the angle of the water spray is changed in 3 steps.		
		Item	Setting	Remarks
		Power	ON	When the Power ON command is input, the power is turned on.
		Water Pressure	-	The configured setting is applied.
		Nozzle Position	-	The configured setting is applied.
		Dryer Temperature	-	The configured setting is applied.
		Water Temperature	-	The configured setting is applied.
		Seat Temperature	-	The configured setting is applied.
		Seat Sensor Detection	ON	Nozzle cleansing is performed regardless of whether a user is seated.
		Flow Rate Sensor	ON	Flow Rate Sensor ON
		Zero_Con	ON	Zero Con ON
	ID Setting		The configured setting is applied.	

Function	Classification	Detailed Operation																																	
Nozzle Sterilization	Operation	<ul style="list-style-type: none"> ▶ The Nozzle Sterilization remote control button operation <ul style="list-style-type: none"> - If the button is pressed: Drains water for self-cleansing ▶ If the Stop Nozzle Sterilization is pressed <ul style="list-style-type: none"> - The operation stopped after 30 seconds of operation. - The operation stops when the Power button is pressed / the Stop remote control button is pressed. - The operation stops when the Nozzle Cleansing button is pressed ▶ During the Nozzle Sterilization operation, pressing buttons other than the Power, Stop remote control and Nozzle Cleansing buttons is not allowed. (The Seat Temp., Wide and Water Temp. buttons will work.) 																																	
		<table border="1"> <thead> <tr> <th>Item</th> <th>Setting</th> <th>Remarks</th> </tr> </thead> <tbody> <tr> <td>Power</td> <td>ON</td> <td>When the Power ON command is input, the power is turned on.</td> </tr> <tr> <td>Water Pressure</td> <td>Self-Cleansing</td> <td>The configured setting is applied.</td> </tr> <tr> <td>Nozzle Position</td> <td>Self-Cleansing</td> <td>The configured setting is applied.</td> </tr> <tr> <td>Dryer Temperature</td> <td>-</td> <td>The configured setting is applied.</td> </tr> <tr> <td>Water Temperature</td> <td>-</td> <td>The configured setting is applied.</td> </tr> <tr> <td>Seat Temperature</td> <td>-</td> <td>The configured setting is applied.</td> </tr> <tr> <td>Seat Sensor Detection</td> <td>ON</td> <td>Nozzle cleansing is performed regardless of whether a user is seated.</td> </tr> <tr> <td>Flow Rate Sensor</td> <td>ON</td> <td>Flow Rate Sensor ON</td> </tr> <tr> <td>Zero_Con</td> <td>ON</td> <td>Zero Con ON</td> </tr> <tr> <td>ID Setting</td> <td></td> <td>The configured setting is applied.</td> </tr> </tbody> </table>	Item	Setting	Remarks	Power	ON	When the Power ON command is input, the power is turned on.	Water Pressure	Self-Cleansing	The configured setting is applied.	Nozzle Position	Self-Cleansing	The configured setting is applied.	Dryer Temperature	-	The configured setting is applied.	Water Temperature	-	The configured setting is applied.	Seat Temperature	-	The configured setting is applied.	Seat Sensor Detection	ON	Nozzle cleansing is performed regardless of whether a user is seated.	Flow Rate Sensor	ON	Flow Rate Sensor ON	Zero_Con	ON	Zero Con ON	ID Setting		The configured setting is applied.
Item	Setting	Remarks																																	
Power	ON	When the Power ON command is input, the power is turned on.																																	
Water Pressure	Self-Cleansing	The configured setting is applied.																																	
Nozzle Position	Self-Cleansing	The configured setting is applied.																																	
Dryer Temperature	-	The configured setting is applied.																																	
Water Temperature	-	The configured setting is applied.																																	
Seat Temperature	-	The configured setting is applied.																																	
Seat Sensor Detection	ON	Nozzle cleansing is performed regardless of whether a user is seated.																																	
Flow Rate Sensor	ON	Flow Rate Sensor ON																																	
Zero_Con	ON	Zero Con ON																																	
ID Setting		The configured setting is applied.																																	

Function	Classification	Detailed Operation																																	
Nozzle Cleansing	Operation	<ul style="list-style-type: none"> ▶ The Main body nozzle cleansing button operation <ul style="list-style-type: none"> - Pressing the button once: The bidet nozzle is fully extended. Drains water for self-cleansing - Pressing the button twice: The bidet nozzle moves to its original position / The cleansing nozzle is fully extended. Drains water for self-cleansing (This is the same operation for the Step remote control button and the Power button.) - Pressing the button three times: The cleansing nozzle moves to its original position. Draining stops. (This is the same operation for the Step remote control button and the Power button.) ▶ If the Stop Nozzle Cleansing button is pressed. <ul style="list-style-type: none"> - It stops after 2 minutes of operation. - It stops when the Power button is pressed. ※ During the nozzle cleansing operation, pressing buttons other than the Power and Stop remote control buttons is not allowed. (The Seat Temp., Wide and Water Temp. buttons will work.) 																																	
<table border="1" style="width: 100%; border-collapse: collapse;"> <thead> <tr> <th data-bbox="320 1211 580 1267">Item</th> <th data-bbox="580 1211 740 1267">Setting</th> <th data-bbox="740 1211 1422 1267">Remarks</th> </tr> </thead> <tbody> <tr> <td data-bbox="320 1267 580 1368">Power</td> <td data-bbox="580 1267 740 1368">ON</td> <td data-bbox="740 1267 1422 1368">When the Power ON command is input, the power is turned on.</td> </tr> <tr> <td data-bbox="320 1368 580 1469">Water Pressure</td> <td data-bbox="580 1368 740 1469">Self-Cleansing</td> <td data-bbox="740 1368 1422 1469">The configured setting is applied.</td> </tr> <tr> <td data-bbox="320 1469 580 1570">Nozzle Position</td> <td data-bbox="580 1469 740 1570">Self-Cleansing</td> <td data-bbox="740 1469 1422 1570">The configured setting is applied.</td> </tr> <tr> <td data-bbox="320 1570 580 1626">Dryer Temperature</td> <td data-bbox="580 1570 740 1626">-</td> <td data-bbox="740 1570 1422 1626">The configured setting is applied.</td> </tr> <tr> <td data-bbox="320 1626 580 1727">Water Temperature</td> <td data-bbox="580 1626 740 1727">-</td> <td data-bbox="740 1626 1422 1727">The configured setting is applied.</td> </tr> <tr> <td data-bbox="320 1727 580 1783">Seat Temperature</td> <td data-bbox="580 1727 740 1783">-</td> <td data-bbox="740 1727 1422 1783">The configured setting is applied.</td> </tr> <tr> <td data-bbox="320 1783 580 1883">Seat Sensor Detection</td> <td data-bbox="580 1783 740 1883">ON</td> <td data-bbox="740 1783 1422 1883">Nozzle cleansing is performed regardless of whether a user is seated.</td> </tr> <tr> <td data-bbox="320 1883 580 1939">Flow Rate Sensor</td> <td data-bbox="580 1883 740 1939">ON</td> <td data-bbox="740 1883 1422 1939">Flow Rate Sensor ON</td> </tr> <tr> <td data-bbox="320 1939 580 1995">Zero_Con</td> <td data-bbox="580 1939 740 1995">ON</td> <td data-bbox="740 1939 1422 1995">Zero Con ON</td> </tr> <tr> <td data-bbox="320 1995 580 2069">ID Setting</td> <td data-bbox="580 1995 740 2069"></td> <td data-bbox="740 1995 1422 2069">The configured setting is applied.</td> </tr> </tbody> </table>			Item	Setting	Remarks	Power	ON	When the Power ON command is input, the power is turned on.	Water Pressure	Self-Cleansing	The configured setting is applied.	Nozzle Position	Self-Cleansing	The configured setting is applied.	Dryer Temperature	-	The configured setting is applied.	Water Temperature	-	The configured setting is applied.	Seat Temperature	-	The configured setting is applied.	Seat Sensor Detection	ON	Nozzle cleansing is performed regardless of whether a user is seated.	Flow Rate Sensor	ON	Flow Rate Sensor ON	Zero_Con	ON	Zero Con ON	ID Setting		The configured setting is applied.
Item	Setting	Remarks																																	
Power	ON	When the Power ON command is input, the power is turned on.																																	
Water Pressure	Self-Cleansing	The configured setting is applied.																																	
Nozzle Position	Self-Cleansing	The configured setting is applied.																																	
Dryer Temperature	-	The configured setting is applied.																																	
Water Temperature	-	The configured setting is applied.																																	
Seat Temperature	-	The configured setting is applied.																																	
Seat Sensor Detection	ON	Nozzle cleansing is performed regardless of whether a user is seated.																																	
Flow Rate Sensor	ON	Flow Rate Sensor ON																																	
Zero_Con	ON	Zero Con ON																																	
ID Setting		The configured setting is applied.																																	

Function	Classification	Detailed Operation																																					
Water temperature adjustment	Water Temperature	<p>▶ The default setting is OFF when the power is supplied.</p> <ul style="list-style-type: none"> - Users can set the water temperature with the Water Temp. button. - Users can set the temperature in 3 steps. - The temperature can be set during a function operation or in the idle state. 																																					
		Types of control	OFF	Step 1	Step 2	Step 3																																	
		Micom-Controlled Temperature	Room temperature	32.5	35.5	38.5																																	
		Measuring standard	Room temperature	31.5	34.5	37.5																																	
		<table border="1"> <thead> <tr> <th>Item</th> <th>Setting</th> <th>Remarks</th> </tr> </thead> <tbody> <tr> <td>Water Pressure</td> <td>-</td> <td>The configured setting is applied.</td> </tr> <tr> <td>Nozzle Position</td> <td>-</td> <td>The configured setting is applied.</td> </tr> <tr> <td>Dryer Temperature</td> <td>-</td> <td>The configured setting is applied.</td> </tr> <tr> <td>Water Temperature</td> <td>-</td> <td>The configured setting is applied.</td> </tr> <tr> <td>Seat Temperature</td> <td>-</td> <td>The configured setting is applied. The seat temperature is set to Step 1 when the unit enters power saving mode.</td> </tr> <tr> <td>Flow Rate Sensor</td> <td>OFF</td> <td>It is turned on when power-saving mode is canceled.</td> </tr> <tr> <td>Zero_Con</td> <td>OFF</td> <td>It is turned on when power-saving mode is canceled.</td> </tr> <tr> <td>ID Setting</td> <td></td> <td>The configured setting is applied.</td> </tr> <tr> <td>Water Pressure</td> <td>-</td> <td>The configured setting is applied.</td> </tr> <tr> <td>Nozzle Position</td> <td>-</td> <td>The configured setting is applied.</td> </tr> </tbody> </table>					Item	Setting	Remarks	Water Pressure	-	The configured setting is applied.	Nozzle Position	-	The configured setting is applied.	Dryer Temperature	-	The configured setting is applied.	Water Temperature	-	The configured setting is applied.	Seat Temperature	-	The configured setting is applied. The seat temperature is set to Step 1 when the unit enters power saving mode.	Flow Rate Sensor	OFF	It is turned on when power-saving mode is canceled.	Zero_Con	OFF	It is turned on when power-saving mode is canceled.	ID Setting		The configured setting is applied.	Water Pressure	-	The configured setting is applied.	Nozzle Position	-	The configured setting is applied.
Item	Setting	Remarks																																					
Water Pressure	-	The configured setting is applied.																																					
Nozzle Position	-	The configured setting is applied.																																					
Dryer Temperature	-	The configured setting is applied.																																					
Water Temperature	-	The configured setting is applied.																																					
Seat Temperature	-	The configured setting is applied. The seat temperature is set to Step 1 when the unit enters power saving mode.																																					
Flow Rate Sensor	OFF	It is turned on when power-saving mode is canceled.																																					
Zero_Con	OFF	It is turned on when power-saving mode is canceled.																																					
ID Setting		The configured setting is applied.																																					
Water Pressure	-	The configured setting is applied.																																					
Nozzle Position	-	The configured setting is applied.																																					

Function	Classification	Detailed Operation																															
Seat Temperature Control	Seat Temperature	<p>► When the power is turned on (initialization), the initial setting is off.</p> <ul style="list-style-type: none"> - Users can set the temperature with the Seat Temp. button. - Users can set the temperature in 4 steps. - The temperature can be set during a function operation or in the idle state. - Seat Temperature Step 1 / Step 2 / Step 3 – Seat LED – ON - The Seat Temperature is not set – Seat LED – OFF 																															
		<table border="1"> <thead> <tr> <th>Types of control</th> <th>OFF</th> <th>Step 1</th> <th>Step 2</th> <th>Step 3</th> </tr> </thead> <tbody> <tr> <td>Micom-Controlled Temperature</td> <td>Room temperature</td> <td>33</td> <td>37</td> <td>41</td> </tr> <tr> <td>Measuring standard</td> <td>Room temperature</td> <td>31 ± 3 °C</td> <td>34 ± 3 °C</td> <td>37 ± 3 °C</td> </tr> <tr> <td>The heater capacity while operating</td> <td colspan="4">-1 ≤ T < Configured Temperature 80% (Frequency = 600 ms) When T < -1, 100% (Frequency = 600 ms)</td> </tr> </tbody> </table>	Types of control	OFF	Step 1	Step 2	Step 3	Micom-Controlled Temperature	Room temperature	33	37	41	Measuring standard	Room temperature	31 ± 3 °C	34 ± 3 °C	37 ± 3 °C	The heater capacity while operating	-1 ≤ T < Configured Temperature 80% (Frequency = 600 ms) When T < -1, 100% (Frequency = 600 ms)														
		Types of control	OFF	Step 1	Step 2	Step 3																											
		Micom-Controlled Temperature	Room temperature	33	37	41																											
		Measuring standard	Room temperature	31 ± 3 °C	34 ± 3 °C	37 ± 3 °C																											
The heater capacity while operating	-1 ≤ T < Configured Temperature 80% (Frequency = 600 ms) When T < -1, 100% (Frequency = 600 ms)																																
<table border="1"> <thead> <tr> <th>Item</th> <th>Setting</th> <th>Remarks</th> </tr> </thead> <tbody> <tr> <td>Power</td> <td>ON</td> <td>The configured setting is applied.</td> </tr> <tr> <td>Water Pressure</td> <td>-</td> <td>The configured setting is applied.</td> </tr> <tr> <td>Nozzle Position</td> <td>-</td> <td>The configured setting is applied.</td> </tr> <tr> <td>Dryer Temperature</td> <td>-</td> <td>The configured setting is applied.</td> </tr> <tr> <td>Water Temperature</td> <td>-</td> <td>The configured setting is applied.</td> </tr> <tr> <td>Seat Temperature</td> <td>-</td> <td>The configured setting is applied.</td> </tr> <tr> <td>Seat Sensor Detection</td> <td>-</td> <td>The configured setting is applied.</td> </tr> <tr> <td>Power-saving function</td> <td>-</td> <td>Step 1</td> </tr> <tr> <td>Zero_Con</td> <td>ON</td> <td></td> </tr> <tr> <td>ID Setting</td> <td></td> <td></td> </tr> </tbody> </table>	Item	Setting	Remarks	Power	ON	The configured setting is applied.	Water Pressure	-	The configured setting is applied.	Nozzle Position	-	The configured setting is applied.	Dryer Temperature	-	The configured setting is applied.	Water Temperature	-	The configured setting is applied.	Seat Temperature	-	The configured setting is applied.	Seat Sensor Detection	-	The configured setting is applied.	Power-saving function	-	Step 1	Zero_Con	ON		ID Setting		
Item	Setting	Remarks																															
Power	ON	The configured setting is applied.																															
Water Pressure	-	The configured setting is applied.																															
Nozzle Position	-	The configured setting is applied.																															
Dryer Temperature	-	The configured setting is applied.																															
Water Temperature	-	The configured setting is applied.																															
Seat Temperature	-	The configured setting is applied.																															
Seat Sensor Detection	-	The configured setting is applied.																															
Power-saving function	-	Step 1																															
Zero_Con	ON																																
ID Setting																																	

Function	Classification	Detailed Operation																														
Auto-power saving function	Setting	<ul style="list-style-type: none"> ▶ When the power-saving mode is set <ul style="list-style-type: none"> - If there is no remote control signal, button input or seating detection, the seat temperature is automatically set to power-saving mode of step 1. - Power-Saving LED – ON Power LED - OFF Seat LED – OFF 																														
	Cancelling	▶ Power-saving mode is canceled in the case of a remote control signal transmission, button input or seating detection, and the previous settings are restored.																														
<table border="1"> <thead> <tr> <th>Item</th> <th>Setting</th> <th>Remarks</th> </tr> </thead> <tbody> <tr> <td>Power</td> <td>ON</td> <td>When the Power ON command is input, the power is turned on.</td> </tr> <tr> <td>Water Pressure</td> <td>-</td> <td>The configured setting is applied.</td> </tr> <tr> <td>Nozzle Position</td> <td>-</td> <td>The configured setting is applied.</td> </tr> <tr> <td>Dryer Temperature</td> <td>-</td> <td>The configured setting is applied.</td> </tr> <tr> <td>Water Temperature</td> <td>-</td> <td>The configured setting is applied.</td> </tr> <tr> <td>Seat Temperature</td> <td>-</td> <td>The configured setting is applied. The seat temperature is set to Step 1 when the unit enters power saving mode.</td> </tr> <tr> <td>Flow Rate Sensor</td> <td>OFF</td> <td>It is turned on when power-saving mode is canceled.</td> </tr> <tr> <td>Zero_Con</td> <td>OFF</td> <td>It is turned on when power-saving mode is canceled.</td> </tr> <tr> <td>ID Setting</td> <td></td> <td>The configured setting is applied.</td> </tr> </tbody> </table>			Item	Setting	Remarks	Power	ON	When the Power ON command is input, the power is turned on.	Water Pressure	-	The configured setting is applied.	Nozzle Position	-	The configured setting is applied.	Dryer Temperature	-	The configured setting is applied.	Water Temperature	-	The configured setting is applied.	Seat Temperature	-	The configured setting is applied. The seat temperature is set to Step 1 when the unit enters power saving mode.	Flow Rate Sensor	OFF	It is turned on when power-saving mode is canceled.	Zero_Con	OFF	It is turned on when power-saving mode is canceled.	ID Setting		The configured setting is applied.
Item	Setting	Remarks																														
Power	ON	When the Power ON command is input, the power is turned on.																														
Water Pressure	-	The configured setting is applied.																														
Nozzle Position	-	The configured setting is applied.																														
Dryer Temperature	-	The configured setting is applied.																														
Water Temperature	-	The configured setting is applied.																														
Seat Temperature	-	The configured setting is applied. The seat temperature is set to Step 1 when the unit enters power saving mode.																														
Flow Rate Sensor	OFF	It is turned on when power-saving mode is canceled.																														
Zero_Con	OFF	It is turned on when power-saving mode is canceled.																														
ID Setting		The configured setting is applied.																														

Function	Classification	Detailed Operation																														
Deodorization function	Setting	<ul style="list-style-type: none"> ▶ Runs for 1 minute when seating is detected (FAN 20 V) Runs for 3 minutes when seating is not detected (FAN 20 V) ▶ Runs for 1 minute when a remote control button is pressed (FAN 24 V) When deodorization is performed due to someone seating, and the Deodorization button is pressed, 24 V is maintained for the remaining period of time. ▶ If the dryer fan or cleansing air pump operation is initiated during the deodorization operation, deodorization operates again when the drying or pump operation is completed and deodorization continues for the remaining period of time. 																														
	Cancelling	▶ When the Stop remote control button or the Power button is pressed.																														
<table border="1"> <thead> <tr> <th>Item</th> <th>Setting</th> <th>Remarks</th> </tr> </thead> <tbody> <tr> <td>Power</td> <td>ON</td> <td>When the Power ON command is input, the power is turned on.</td> </tr> <tr> <td>Water Pressure</td> <td>-</td> <td>The configured setting is applied.</td> </tr> <tr> <td>Nozzle Position</td> <td>-</td> <td>The configured setting is applied.</td> </tr> <tr> <td>Dryer Temperature</td> <td>-</td> <td>The configured setting is applied.</td> </tr> <tr> <td>Water Temperature</td> <td>-</td> <td>The configured setting is applied.</td> </tr> <tr> <td>Seat Temperature</td> <td>-</td> <td>The configured setting is applied. The seat temperature is set to Step 1 when the unit enters power saving mode.</td> </tr> <tr> <td>Flow Rate Sensor</td> <td>ON</td> <td></td> </tr> <tr> <td>Zero_Con</td> <td>ON</td> <td></td> </tr> <tr> <td>ID Setting</td> <td></td> <td>The configured setting is applied.</td> </tr> </tbody> </table>			Item	Setting	Remarks	Power	ON	When the Power ON command is input, the power is turned on.	Water Pressure	-	The configured setting is applied.	Nozzle Position	-	The configured setting is applied.	Dryer Temperature	-	The configured setting is applied.	Water Temperature	-	The configured setting is applied.	Seat Temperature	-	The configured setting is applied. The seat temperature is set to Step 1 when the unit enters power saving mode.	Flow Rate Sensor	ON		Zero_Con	ON		ID Setting		The configured setting is applied.
Item	Setting	Remarks																														
Power	ON	When the Power ON command is input, the power is turned on.																														
Water Pressure	-	The configured setting is applied.																														
Nozzle Position	-	The configured setting is applied.																														
Dryer Temperature	-	The configured setting is applied.																														
Water Temperature	-	The configured setting is applied.																														
Seat Temperature	-	The configured setting is applied. The seat temperature is set to Step 1 when the unit enters power saving mode.																														
Flow Rate Sensor	ON																															
Zero_Con	ON																															
ID Setting		The configured setting is applied.																														

Function	Classification	Detailed Operation																														
Remaining water draining function	Setting	<p>▶ When the Power and Cleaning buttons on the main body are pressed at the same time and are held for 1 second</p> <ul style="list-style-type: none"> - The valve is ON - Self-cleansing for 10 seconds → Nozzle cleansing for 10 seconds → Nozzle bidet for 10 seconds → Valve OFF → Nozzle moves to the 2-Way/4-Way original position → Seating setting <p>※ Pressing a remote control or main body button during the 30 seconds of the remaining water being drained is not allowed (except Seat Temp, Wide and Water Temp. buttons).</p>																														
		<table border="1"> <thead> <tr> <th>Item</th> <th>Setting</th> <th>Remarks</th> </tr> </thead> <tbody> <tr> <td>Power</td> <td>ON</td> <td>When the Power ON command is input, the power is turned on.</td> </tr> <tr> <td>Water Pressure</td> <td>-</td> <td>The configured setting is applied.</td> </tr> <tr> <td>Nozzle Position</td> <td>-</td> <td>The configured setting is applied.</td> </tr> <tr> <td>Dryer Temperature</td> <td>-</td> <td>The configured setting is applied.</td> </tr> <tr> <td>Water Temperature</td> <td>-</td> <td>The configured setting is applied.</td> </tr> <tr> <td>Seat Temperature</td> <td>-</td> <td>The configured setting is applied.</td> </tr> <tr> <td>Flow Rate Sensor</td> <td>ON</td> <td></td> </tr> <tr> <td>Zero_Con</td> <td>ON</td> <td></td> </tr> <tr> <td>ID Setting</td> <td></td> <td>The configured setting is applied.</td> </tr> </tbody> </table>	Item	Setting	Remarks	Power	ON	When the Power ON command is input, the power is turned on.	Water Pressure	-	The configured setting is applied.	Nozzle Position	-	The configured setting is applied.	Dryer Temperature	-	The configured setting is applied.	Water Temperature	-	The configured setting is applied.	Seat Temperature	-	The configured setting is applied.	Flow Rate Sensor	ON		Zero_Con	ON		ID Setting		The configured setting is applied.
	Item	Setting	Remarks																													
	Power	ON	When the Power ON command is input, the power is turned on.																													
	Water Pressure	-	The configured setting is applied.																													
	Nozzle Position	-	The configured setting is applied.																													
	Dryer Temperature	-	The configured setting is applied.																													
	Water Temperature	-	The configured setting is applied.																													
	Seat Temperature	-	The configured setting is applied.																													
	Flow Rate Sensor	ON																														
Zero_Con	ON																															
ID Setting		The configured setting is applied.																														

Function	Classification	Detailed Operation																														
Test mode function	Entering	<p>▶ Supply power after pressing the Power button. The version number is displayed for 1 second and the unit works normally (the version number is displayed as a hexadecimal number on the LED.)</p>																														
	Infinite Operation	<p>▶ Test mode continues forever until the Stop button is pressed after the Rear Cleansing / Front Cleansing / Dry remote control button is pressed.</p>																														
	Repetitive Operation	<p>▶ If the Rear Cleansing button on the main body is pressed, Rear Cleansing for 1 minute, Front Cleansing for 1 minute and then drying for 2 minutes are repeatedly performed. If the Move button is pressed, the nozzle moves until the Move button is released.</p> <p>※ The operation is repeated until the power cord is unplugged.</p>																														
	ID Setting	<p>If the ID is set in Text mode, the ID is saved to the EEPROM and Test mode is canceled.</p>																														
<table border="1"> <thead> <tr> <th>Item</th> <th>Setting</th> <th>Remarks</th> </tr> </thead> <tbody> <tr> <td>Power</td> <td>ON</td> <td>When the Power ON command is input, the power is turned on.</td> </tr> <tr> <td>Water Pressure</td> <td>-</td> <td>The configured setting is applied.</td> </tr> <tr> <td>Nozzle Position</td> <td>-</td> <td>The configured setting is applied.</td> </tr> <tr> <td>Dryer Temperature</td> <td>-</td> <td>The configured setting is applied.</td> </tr> <tr> <td>Water Temperature</td> <td>-</td> <td>The configured setting is applied.</td> </tr> <tr> <td>Seat Temperature</td> <td>-</td> <td>The configured setting is applied. The seat temperature is set to Step 1 when the unit enters power saving mode.</td> </tr> <tr> <td>Flow Rate Sensor</td> <td>ON</td> <td></td> </tr> <tr> <td>Zero_Con</td> <td>ON</td> <td></td> </tr> <tr> <td>ID Setting</td> <td></td> <td>The configured setting is applied.</td> </tr> </tbody> </table>			Item	Setting	Remarks	Power	ON	When the Power ON command is input, the power is turned on.	Water Pressure	-	The configured setting is applied.	Nozzle Position	-	The configured setting is applied.	Dryer Temperature	-	The configured setting is applied.	Water Temperature	-	The configured setting is applied.	Seat Temperature	-	The configured setting is applied. The seat temperature is set to Step 1 when the unit enters power saving mode.	Flow Rate Sensor	ON		Zero_Con	ON		ID Setting		The configured setting is applied.
Item	Setting	Remarks																														
Power	ON	When the Power ON command is input, the power is turned on.																														
Water Pressure	-	The configured setting is applied.																														
Nozzle Position	-	The configured setting is applied.																														
Dryer Temperature	-	The configured setting is applied.																														
Water Temperature	-	The configured setting is applied.																														
Seat Temperature	-	The configured setting is applied. The seat temperature is set to Step 1 when the unit enters power saving mode.																														
Flow Rate Sensor	ON																															
Zero_Con	ON																															
ID Setting		The configured setting is applied.																														

Function	Classification		Detailed Operation
Configuration Mode	ID Setting	Remove control address setting	<ul style="list-style-type: none"> ▶ The remote control address is set to 1 as a factory default. (Refer to Setting Special Remote Control Functions) ▶ Refer to the Remote Control Operations ▶ The ID can be configured in Test mode. (Test mode is automatically canceled after setting the ID)
		Entering Special Mode	<ul style="list-style-type: none"> ▶ Pressing the Power + Rear Cleansing button combination enters Special mode. The corresponding function state LED blinks at 200 ms interval. ※ Power LED – Indicates the Mute setting. Power-Saving LED – Indicates power-saving mode. Seat LED – Indicates the seating sensing function setting.
	Exiting Special Mode	<ul style="list-style-type: none"> ▶ Special mode is exited when the Power + Rear Cleansing button combination is pressed in Special mode or no key is pressed for 10 seconds. 	
	Mute mode	<ul style="list-style-type: none"> ▶ Mute mode is disabled by default (the bell rings.) ▶ Mute mode is enabled or disabled whenever the Power button is pressed. 	
	Seating Sensing Mode	<ul style="list-style-type: none"> ▶ Seating sensing is enabled by default. ▶ Seating Sensing mode is enabled or disabled whenever the Cleansing button on the main body is pressed. 	
	Power-Saving Mode	<ul style="list-style-type: none"> ▶ Power-Saving mode is enabled by default. ▶ Power-Saving mode is enabled or disabled whenever the Cleansing button is pressed. 	
	Saving Special Mode (EEPROM)	<ul style="list-style-type: none"> ▶ The settings are saved to the EEPROM if the Power + Rear Cleansing button combination is pressed in Special mode or no key is pressed for 10 seconds. - If the power is cut off within 10 seconds, the settings are not saved. 	

Function	Classification	Detailed Operation	
Line Aging Mode	Entering	1) Plug in the power cord while the Rear Cleansing button on the main body is held down.	
	Original Position Operation	2) 2-Way/4-Way Original Position Operation. Rear and Front Cleansing Nozzle Original Position Operation	
	Cleansing Operation	3) The feed water valve is turned on after completing the original position operation. 4) The rear cleansing nozzle is fully extended (water temperature setting: Step 3) 5) The water pressure for rear cleansing begins as step 1 and then automatically changes to steps 2 and 3 in turns at 4-second intervals. 6) When water pressure is complete, the nozzle automatically moves to the positions corresponding to Steps 4-3-2-1 at 4 second intervals. 7) When the nozzle movement is complete, Wide is set to Step 2 and then Wide is automatically set to Step 3 after 4 seconds.	
	Front Cleansing Operation	8) When cleansing wide is complete, cleansing stops and Front Cleansing begins. 9) The front cleansing nozzle is fully extended (water temperature setting: Step 3). 10) The water pressure for front cleansing begins as step 1 and then automatically changes to steps 2 and 3 in turns at 4-second intervals. 11) When the water pressure change is completed, the nozzle automatically moves to the positions corresponding to Steps 4-3-2-1 at 4 second intervals. 12) When the nozzle movement is complete, Wide is set to Step 2 and then Wide is automatically set to Step 3 after 4 seconds.	
	Drying Operation	13) When wide front cleansing is complete, front cleansing stops and drying begins in Step 3.	
	Deodorization Operation	14) When drying stops after 15 seconds, the deodorization fan rotates.	
	Completion	15) The deodorization fan stops after 15 seconds and the unit changes to standby state.	
	※ When entering Line Aging Mode (the remote control buttons and the Rear Cleansing/Cleansing buttons on the main body will not work.) <ul style="list-style-type: none"> - The seat temperature is set to Step 2 - Line Aging Mode stops if the Power button on the main body is pressed. 		

8-2-6 The Water Flow Volume for each Step of the Rear/Front Cleansing operations

■ The rear/front cleansing water flow volume

Step	Step 1	Step 2	Step 2	Remarks
Water flow volume (ml/min)	350 (±50)	420 (±50)	420 (±50)	

※ The water flow volume may differ depending on the product.

8-2-7 Power Consumption (Electric charge under the full-loading condition)

- Standard for calculation (4-person family - 2 males and 2 females) / Number of uses per day : 4 x rear cleansing, 8 x front cleansing, 12 x drying, 12 x deodorization, 12 x nozzle cleansing
 - Case 1 (summer): Step 3 of water flow volume, step 3 of water temperature, step 3 of dryer temperature, step 3 of seat temperature (standby temperature: 20 °C, feed water temperature: 20 °C)
 - Case 2 (winter): Step 3 of water flow volume, step 3 of water temperature, step 3 of dryer temperature, step 3 of seat temperature (standby temperature: 18 °C, feed water temperature: 5 °C)

■ Power consumption for BA13

Model	Location (Use)	Number of Users	Conditions	Power Consumption (1 day)	Power Consumption (1 month)
BA13	Home	4 persons	Summer (feed water temperature: 20 °C)	503 Wh	15 kWh
			Winter (feed water temperature: 5 °C)	602.6 Wh	18 kWh

■ Calculation Basis

Item	Average number of uses per day	Period of time for each use	Period of time per day
Rear Cleansing	8	1 min	8 min
Front Cleansing	4	1 min	4 min
Drying	12	2 min	24 min
Deodorization	12	1 min	12 min
Nozzle Cleaning	12	30 sec	6 min

8-2-8 Resistance value and voltage per temperature sensor (T1, T2, Seat) temperature (10.74 kΩ / 25 °C / 2.5 V)

Temperature (°C)	Resistance (kΩ)	Voltage (V)	Temperature (°C)	Resistance (kΩ)	Voltage (V)	Temperature (°C)	Resistance (kΩ)	Voltage (V)	Temperature (°C)	Resistance (kΩ)	Voltage (V)
1	28.71	3.71	26	10.34	2.54	51	4.26	1.49	76	1.96	0.82
2	27.48	3.67	27	9.95	2.49	52	4.12	1.46	77	1.91	0.80
3	26.31	3.62	28	9.59	2.45	53	3.99	1.43	78	1.85	0.78
4	25.19	3.58	29	9.23	2.40	54	3.86	1.39	79	1.80	0.76
5	24.13	3.54	30	8.90	2.35	55	3.74	1.36	80	1.75	0.74
6	23.12	3.49	31	8.57	2.31	56	3.62	1.33	81	1.47	0.64
7	22.16	3.45	32	8.26	2.26	57	3.51	1.30	82	1.43	0.63
8	21.24	3.40	33	7.97	2.22	58	3.40	1.27	83	1.39	0.61
9	20.37	3.35	34	7.68	2.17	59	3.29	1.24	84	1.35	0.59
10	19.53	3.31	35	7.41	2.13	60	3.19	1.21	85	1.31	0.58
11	18.74	3.26	36	7.15	2.08	61	3.09	1.18	86	1.27	0.56
12	17.98	3.21	37	6.90	2.04	62	2.99	1.15	87	1.24	0.55
13	17.26	3.17	38	6.65	2.00	63	2.90	1.12	88	1.20	0.54
14	16.57	3.12	39	6.42	1.96	64	2.81	1.10	89	1.17	0.52
15	15.91	3.07	40	6.20	1.91	65	2.73	1.07	90	1.14	0.51
16	15.28	3.02	41	5.99	1.87	66	2.64	1.05	91	1.10	0.50
17	14.68	2.97	42	5.78	1.83	67	2.57	1.02	92	1.07	0.48
18	14.11	2.93	43	5.59	1.79	68	2.49	1.00	93	1.04	0.47
19	13.56	2.88	44	5.40	1.75	69	2.41	0.97	94	1.02	0.46
20	13.03	2.83	45	5.21	1.71	70	2.34	0.95	95	0.99	0.45
21	12.53	2.78	46	5.04	1.68	71	2.27	0.93	96	0.96	0.44
22	12.06	2.73	47	4.87	1.64	72	2.21	0.90	97	0.93	0.43
23	11.60	2.68	48	4.71	1.60	73	2.14	0.88	98	0.91	0.42
24	11.16	2.64	49	4.56	1.56	74	2.08	0.86	99	0.88	0.41
25	10.74	2.59	50	4.41	1.53	75	2.02	0.84	100	0.86	0.40

8-3 After services

8-3-1 Cleaning the nozzles

- ※ If excessive force is exerted on the nozzles when cleaning them, the nozzles may no longer work properly or break. Hold the nozzles lightly when cleaning them.
- ※ When cleaning the nozzles, Nozzle cleaning water is emitted. (However, when main water supply is not supplied (main water supply stop status), no nozzle cleaning water is emitted and only the nozzle is extended).

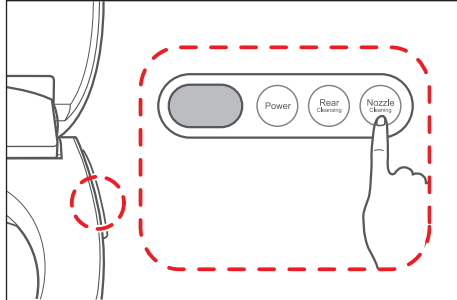
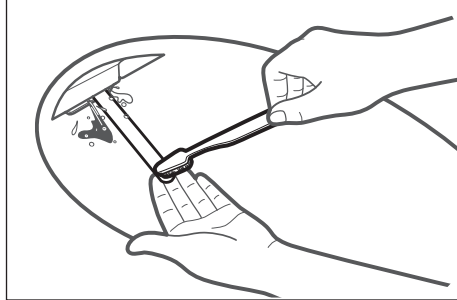
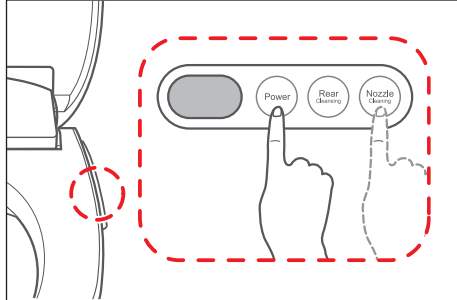
No.	Explanation	Reference picture
1	1) Press the 'Nozzle Cleaning' button on the control panel to the right of the bidet. - Nozzle cleansing water is sprayed and the front nozzle is fully extended. - Clean the front nozzle.	
2	1) Press the 'Nozzle Cleaning' button on the operation part again. - Nozzle cleaning water is sprayed, the front nozzle retracts itself, and rear nozzle is extended fully. - Clean the rear nozzle.	
3	1) If you press the 'Power' button or the 'Nozzle Cleaning' button on the operation part again after cleaning the nozzles, nozzle cleaning water is sprayed, and the rear nozzle retracts itself. - If no button is pressed for 2 minutes after the nozzle cleaning starts, the nozzle retracts itself automatically.	

8-3-2 Cleaning the product body

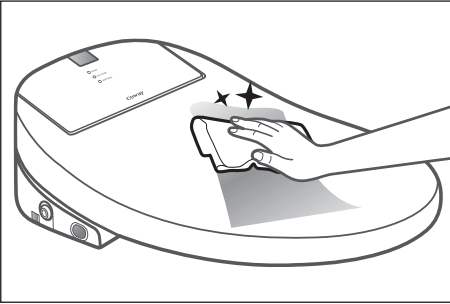

- Do not use thinner, or benzene.
Do not clean the product using a coarse scrub or abrasive detergent.

No.	Explanation	Reference picture
1	1) Apply a neutral detergent to a soft cloth or sponge and clean the product. - Failing to do so may result in deformation or product damage.	

8-3-3 Removing the product

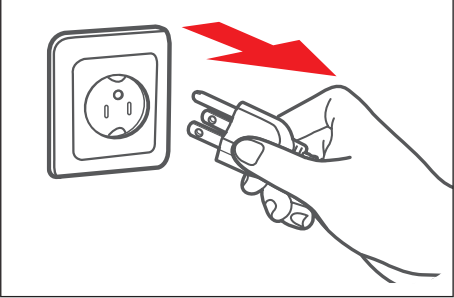
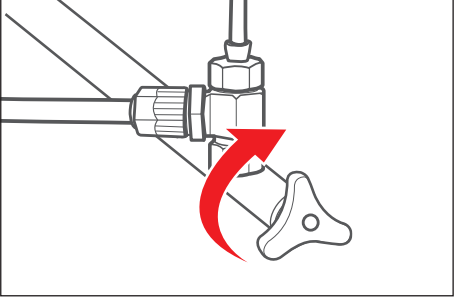
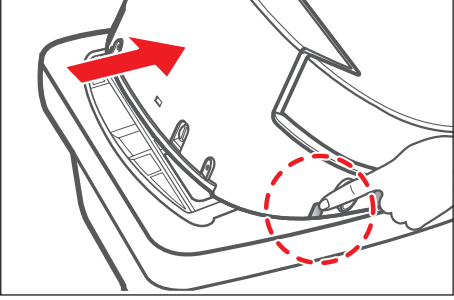
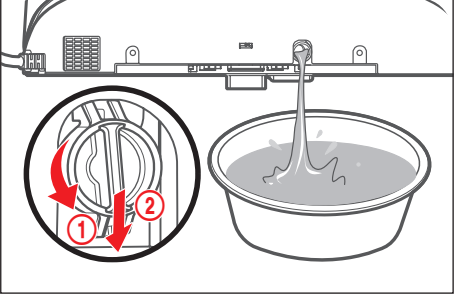
No.	Explanation	Reference picture
1	1) Unplug the power cord from the outlet.	
2	1) Close the main water supply valve.	
3	1) Pull the product forwards by holding both sides of the product while pressing the button at the bottom left of the product, to separate the product from the fixing plate. ※ Unplug the product if it will not be used for a long time.	
4	1) Remove the drain plug at the back of the bidet by turning it in the order numbered so that the water in the hot water tank is drained into the toilet. After draining the water, install the drain plug again by turning it so that it stays in place.	

8-3-4 Cleaning the MESH filter

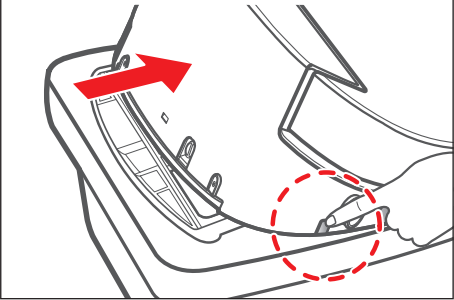
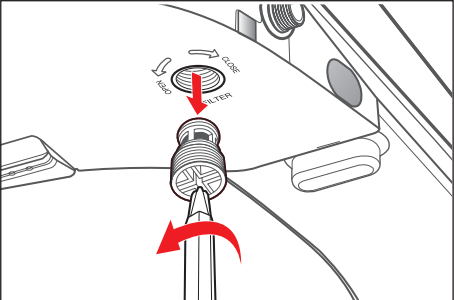
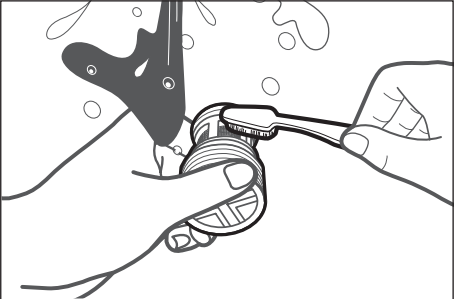
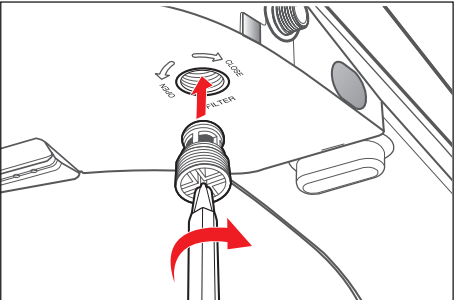
No.	Explanation	Reference picture
1	1) Separate the product from the fixing plate. - Refer to Removing the product (1~3).	
2	1) Remove the MESH filter at the bottom left of the product. - Remove the MESH filter by turning it with a '+' screw driver.	
3	1) Clean the MESH filter by shaking it under flowing water. - Removing foreign substances from the MESH filter with a toothbrush is more effective. - Do not clean the MESH filter excessively, as it may damage the MESH.	
4	1) Reinstall the cleaned MESH filter into the product. - Check that the MESH filter is installed correctly. - If you open the main water supply valve when the MESH filter is not completely installed, water leakage may occur. ※ When not using the product for a long period of time, clean the filter before using the product again. ※ The filter cleaning interval may differ depending on the water quality.	

MEMO

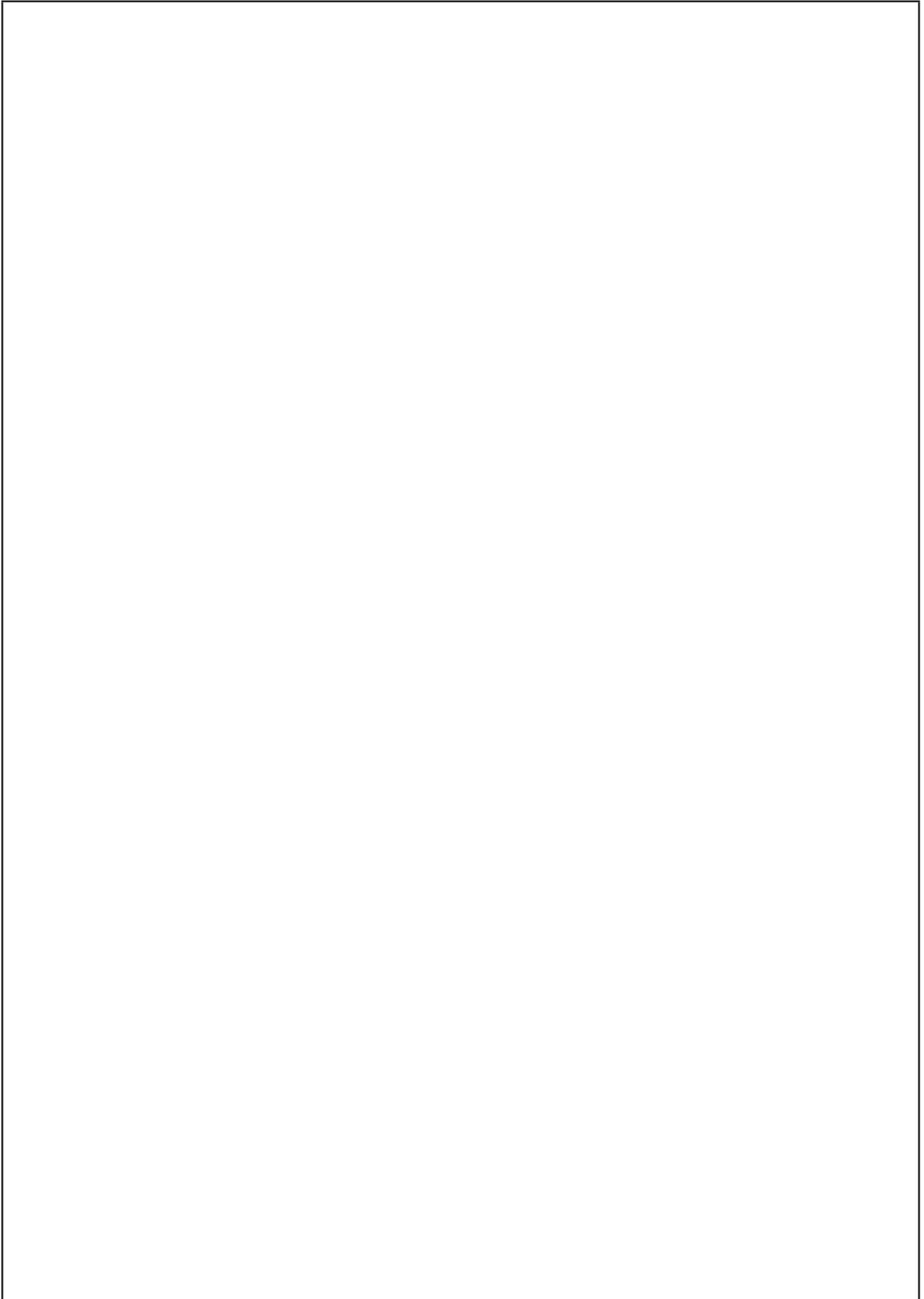

MEMO

